











2013 – 2014



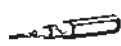

Uwagi:

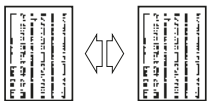
1. Niniejsza lista jest przeznaczona wyłącznie w celu dokonania wyboru produktu.
2. W momencie publikacji niniejszej listy wszystkie uprzednio opublikowane listy tracą swoją ważność.
3. Treść nie może być użyta na poparcie akcji prawnych.
4. Zmiany zastrzeżone.

	⇒		_____	I
	⇒			_____ II - IV
	⇒		_____	1 - 121
			_____	122 - 251
	↔		_____	252 - 313
			_____	314 - 328
PS (HP) <--> kW			_____	329

Przewód zapłonowy z aktywną rezystancją

Przewód ten składa się z rdzenia z włókna szklanego o średnicy 7 mm (8 mm w przypadku przewodu dla Forda) pokrytej warstwą węgla. Rezystancja przewodu obliczona dla celów ustalenia poziomu zakłóceń radioelektrycznych wynosi 10–23 kΩ/m. System ten jest używany przez Opla, Forda, Fiata, Alfa Romeo, Mazdę, Hondę i wiele innych firm.

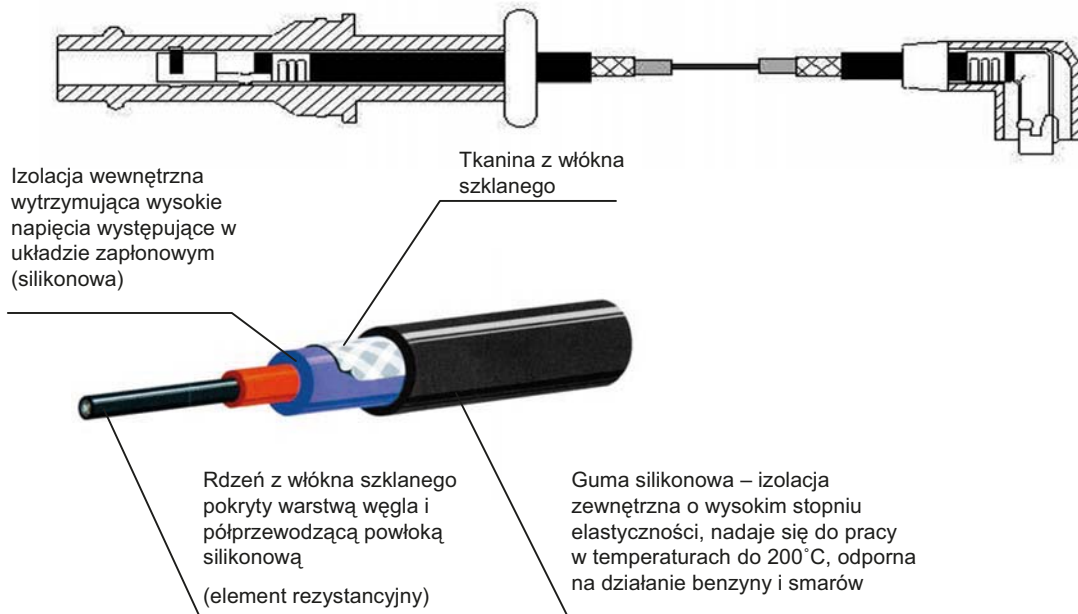

Przewód zapłonowy reaktancyjny

Przewód ten składa się z rdzenia z włókna szklanego pokrytego warstwą węgla oraz z przewodnika metalicznego. Rezystancja przewodu obliczona dla celów ustalenia poziomu zakłóceń radioelektrycznych wynosi dla wysokich napięć 1,8 – 2,2 kΩ/m. System ten jest używany przez między innymi Citroena, Peugeota, Renaulta, Toyotę, Nissan i Volvo.

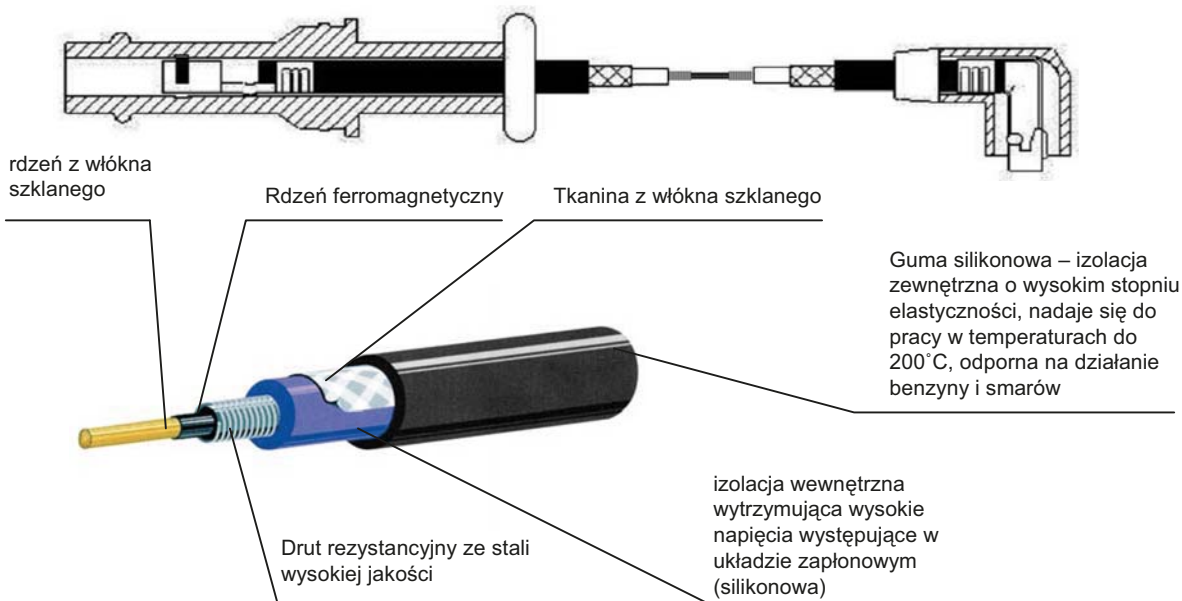

Przewód wysokiego napięcia z rdzeniem i ekranowanymi złączami

Przewód ten charakteryzuje się rdzeniem miedzianym o średnicy 7 mm. Elementy tłumiące zakłócenia wbudowane są w fajkę i we wtyczkę wkładaną w gniazdo kopolki rozdzielacza. W ten sposób elementy odłoczące są blisko źródeł zakłóceń radioelektrycznych. System ten jest używane głównie w samochodach Audi, BMW, Mercedes i Volkswagen.

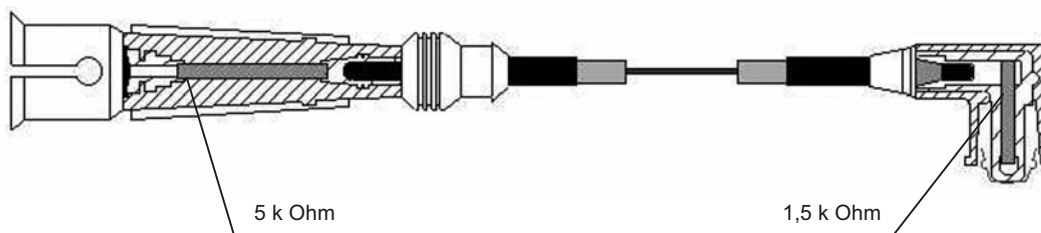

Uwaga



OK !



Zły !



OPIS SPOSOBU OZNACZANIA PRZEWODÓW ZAPŁONOWYCH NGK

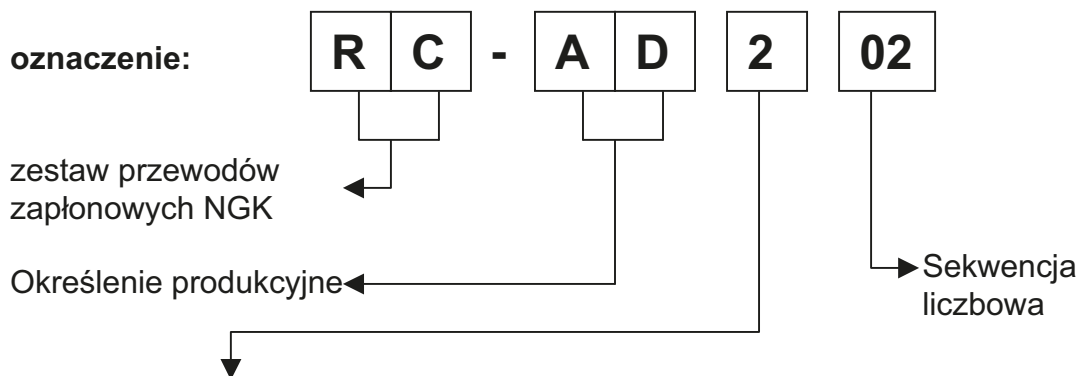

Technologia wykonania przewodów:

- | | | |
|-------------------------|------------|--|
| 1 oraz 2 oraz 9 oraz 11 | CIL | Przewód wysokiego napięcia z rdzeniem miedzianym i ekranowanym połączeniem |
| 3 oraz 4 oraz 12 | RIL | Przewód wysokiego napięcia z aktywną rezystancją |
| 5 oraz 8 | RIL | Przewód wysokiego napięcia z aktywną rezystancją |
| 6 oraz 7 oraz 13 | WIL | Przewód wysokiego napięcia reaktancyjny |

Przykład: RC-AD202

Przewód wysokiego napięcia z rdzeniem miedzianym i ekranowanym Połączeniem; Audi





kW

C
y
l

Stock-No.

ALFA ROMEO**33**

1,2	50	05.87 - 06.90	AR30585	4		RC-AR604	8230
1,3	63	05.85 - 06.90	AR30168	4		RC-AR604	8230
1,3	66	07.90 - 09.92	AR30732	4		RC-AR911	8627
1,4	58	10.82 - 06.90	AR30586	4		RC-AR403	0527
1,4	58	10.82 - 04.87	AR30502	4		RC-AR403	0527
1,4	65	09.91 - 12.95	AR30753	4		RC-AR602	8195
1,4	66	07.90 - 12.95	AR30755	4	DIN fitment	RC-AR911	8627
1,5	62	10.82 - 06.85	AR30143	4		RC-AR403	0527
1,5	62	07.83 - 04.85	AR30504	4		RC-AR403	0527
1,5	66	04.84 - 04.87	AR30520	4		RC-AR403	0527
1,5	70	10.82 - 04.87	AR30182	4		RC-AR403	0527
1,5	70	05.85 - 04.87	AR30514	4		RC-AR403	0527
1,5	70	01.88 - 07.90	AR30508	4		RC-AR403	0527
1,5	72	07.90 - 12.95	AR30751	4	DIN fitment	RC-AR911	8627
1,5	77	06.84 - 12.88	AR30146	4		RC-AR604	8230
1,5	77	07.85 - 04.87	AR30526	4		RC-AR403	0527
1,5	77	07.85 - 04.87	AR30146	4		RC-AR403	0527
1,5	77	04.87 - 07.90	AR30588	4		RC-AR403	0527
1,5	77	04.87 - 07.90	AR30588	4		RC-AR604	8230
1,5	79	05.87 - 06.90	AR30520	4		RC-AR403	0527
1,7	77	05.87 - 06.90	AR30558	4	M4 fitment	RC-AR914	7307
1,7	77	05.87 - 06.90	AR30558	4		RC-AR604	8230
1,7	79	07.90 - 08.91	AR30736	4	DIN fitment	RC-AR911	8627
1,7	79	07.90 - 12.95	AR30737	4	DIN fitment	RC-AR911	8627
1,7	79	07.90 - 08.91	AR30736	4	M4 fitment	RC-AR914	7307
1,7	79	07.90 - 12.95	AR30737	4	M4 fitment	RC-AR914	7307
1,7	87	04.86 - 06.90	AR30550	4		RC-AR604	8230
1,7	97	07.90 - 09.93	AR30347	4		RC-AR604	8230
1,7	97	07.90 - 12.95	AR30747	4		RC-AR604	8230

75

1,6	76	05.89 - 12.92	AR61101	4		RC-AR1101	44235
1,6	81	05.85 - 04.89	AR61101	4		RC-AR610	7201
1,6	81	05.85 - 04.89	AR06100	4		RC-AR610	7201
1,8	88	05.85 - 12.87	AR06202	4		RC-AR610	7201
1,8	88	01.88 - 08.91	AR06168	4		RC-AR1101	44235
1,8	95	05.87 - 12.92	AR61201	4		RC-AR610	7201
1,8	108	05.89 - 08.92	AR06134	4		RC-AR406	0530
1,8	110	05.89 - 12.91	AR06134	4		RC-AR406	0530
1,8	118	12.86 - 12.91	AR06134	4		RC-AR406	0530
2,0	96	05.85 - 04.89	AR06212	4		RC-AR610	7201
2,0 Twin Spark	107	04.87 - 05.92	AR06224	4		RC-FT1101	44236
2,5	113	09.86 - 04.89	AR01648	6		RC-AR201	0520
2,5	118	05.85 - 04.89	AR01646	6		RC-AR201	0520
3,0	136	04.87 - 12.92	AR06124	6		RC-AR201	0520
3,0	138	09.86 - 04.89	AR06120	6		RC-AR201	0520
3,0	141	05.89 - 08.92	AR61503	6		RC-AR201	0520

90

1,8	85	07.85 - 12.88	AR06202	4		RC-AR406	0530
1,8	88	09.84 - 12.88	AR06202	4		RC-AR406	0530
2,0	96	09.84 - 08.92	AR01713	4		RC-AR406	0530
2,0	96	09.84 - 12.88	AR06212	4		RC-AR406	0530
2,0	97	01.85 - 12.88	AR06210	6		RC-AR406	0530

145

1,4	66	07.94 - 09.96	AR33501	4		RC-AR602	8195
1,4 Twin Spark	76	03.96 - 10.01	AR33503	4		RC-AR903	8597
1,6	76	07.94 - 09.96	AR33201	4	M4 fitment	RC-AR914	7307



kW

C
y
l

Stock-No.

ALFA ROMEO**145**

1,6 Twin Spark	88	03.96 - 10.01	AR67601	4		RC-AR601	8194
1,7	95	07.94 - 09.96	AR33401	4		RC-AR204	0523
1,8 Twin Spark	103	10.96 - 02.99	AR67106	4		RC-AR901	8582
1,8 Twin Spark	106	03.96 - 10.01	AR32201	4		RC-AR204	0523
2,0 Twin Spark	110	10.96 - 02.99	AR67204	4		RC-AR903	8597
2,0	114	03.96 - 10.01	AR32301	4		RC-AR903	8597

146

1,4	66	05.95 - 09.96	AR33501	4		RC-AR602	8195
1,4 Twin Spark	76	10.96 - 10.01	AR33503	4		RC-AR903	8597
1,6	76	05.95 - 09.96	AR33201	4	M4 fitment	RC-AR914	7307
1,6 Twin Spark	88	10.96 - 10.01	AR67601	4		RC-AR601	8194
1,7	95	05.95 - 09.96	AR33401	4		RC-AR204	0523
1,8 Twin Spark	103	10.96 - 02.99	AR67106	4		RC-AR901	8582
1,8 Twin Spark	106	03.96 - 10.01	AR32201	4		RC-AR204	0523
2,0	110	05.95 - 09.96	AR67204	4		RC-AR903	8597
2,0	114	03.99 - 10.01	AR32301	4		RC-AR903	8597

147

1,6 Twin Spark	76	10.00 -	AR37203	4		RC-AR1102	44255
1,6 Twin Spark	88	10.00 -	AR32104	4		RC-AR1102	44255
2,0 Twin Spark	110	10.00 -	AR32310	4		RC-AR1102	44255

155

1,6 Twin Spark	88	05.96 - 12.97	AR67601	4		RC-AR601	8194
1,7 Twin Spark	83	06.92 - 05.95	AR67103	4		RC-AR908	8620
1,7 Twin Spark	85	04.93 - 03.96	AR67105	4		RC-AR908	8620
1,8 Twin Spark	77	03.92 - 03.95	AR67402	4		RC-AR908	8620
1,8 Twin Spark	93	03.92 - 05.95	AR67101	4		RC-AR908	8620
1,8 Twin Spark	93	03.92 - 04.96	AR67102	4		RC-AR908	8620
1,8 Twin Spark	103	05.96 - 12.97	AR67106	4		RC-AR908	8620
2,0 Twin Spark	104	03.92 - 05.95	AR67202	4		RC-AR908	8620
2,0 Twin Spark	107	03.92 - 05.95	AR67201	4		RC-AR908	8620
2,0 Twin Spark	110	06.95 - 12.97	AR67204	4		RC-AR908	8620
2,0 Turbo Q4	140	03.92 - 12.97	AR67203	4		RC-FT1301	44259
2,5	120	06.95 - 12.97	AR67303	6		RC-LC901	8575
2,5	121	03.92 - 05.95	AR67302	6		RC-LC901	8575
2,5	121	03.92 - 12.93	AR67301	6		RC-LC901	8575

156

1,6 Twin Spark	88	11.97 - 04.00	AR67601	4		RC-AR903	8597
1,6 Twin Spark	88	11.97 - 09.00	AR32102	4		RC-AR903	8597
1,6 Twin Spark	88	10.00 - 05.06	AR32102	4		RC-AR1102	44255
1,6 Twin Spark	88	05.00 - 10.01	AR32103	4		RC-AR903	8597
1,6 Twin Spark	88	05.00 -	AR32104	4		RC-AR1102	44255
1,8 Twin Spark	103	05.00 -	AR32205	4		RC-AR1102	44255
1,8 Twin Spark	106	11.97 - 10.01	AR32201	4		RC-AR903	8597
2,0 Twin Spark	110	05.00 - 05.02	AR32310	4		RC-AR1102	44255
2,0 Twin Spark	114	11.97 - 04.00	AR32301	4		RC-AR903	8597

164

2,0 Twin Spark	106	11.92 - 12.98	AR64103	4		RC-AR906	8617
2,0 Twin Spark	109	06.87 - 06.90	AR06420	4	DIN fitment	RC-AR913	8630
2,0	129	02.88 - 10.92	AR06476	4		RC-AR603	8224
2,0	148	07.90 - 12.98	AR64102	6		RC-AR205	0524
2,0	152	07.90 - 10.92	AR64101	6		RC-AR205	0524
2,5	120	09.92 - 09.98	AR66201	6		RC-AR205	0524
3,0	132	11.92 - 02.95	AR64305	6		RC-AR912	8629
3,0	132	03.95 - 12.98	AR66303	6		RC-AR912	8629
3,0	135	11.87 - 10.92	AR06412	6		RC-AR912	8629



kW

C
y
i

Stock-No.

ALFA ROMEO**164**

3.0	147	02.88 - 10.92	AR64301	6		RC-AR912	8629
-----	-----	---------------	---------	---	--	----------	------

166

2.0 Twin Spark	110	07.00 - 09.03	AR36301	4		RC-AR1102	44255
2.0 Twin Spark	114	08.98 - 06.00	AR34103	4		RC-AR903	8597

Alfasud

1,2	46	05.73 - 06.84	AS30102	4		RC-AR403	0527
1,2	50	05.73 - 06.84	AS30104	4		RC-AR403	0527
1,3	48	02.78 - 04.80	AS30180	4		RC-AR403	0527
1,3	50	05.78 - 04.80	AS30180	4		RC-AR403	0527
1,3	51	05.78 - 06.84	AS30160	4		RC-AR403	0527
1,3	55	05.78 - 04.84	AS30184	4		RC-AR403	0527
1,3	57	04.78 - 06.84	AS30164	4		RC-AR403	0527
1,3	57	04.78 - 04.80	AS30160	4		RC-AR403	0527
1,3	63	05.80 - 06.84	AS30168	4		RC-AR403	0527
1,3	64	04.77 - 07.79	AS30184	4		RC-AR403	0527
1,5	64	09.77 - 06.84	AS30124	4		RC-AR403	0527
1,5	70	05.80 - 06.84	AS30128	4		RC-AR403	0527
1,5	77	05.80 - 06.84	AS30128	4		RC-AR403	0527
1,5	77	09.81 - 06.84	AS30146	4		RC-AR403	0527
1,7	87	10.87 - 12.89	AS30550	4		RC-AR403	0527

Alfetta

1,6	80	06.74 - 12.85	AR01600	4		RC-AR406	0530
1,6 GT	80	06.74 - 04.81	AR01600	4		RC-AR406	0530
1,8 GT	85	10.75 - 08.77	AR01608	4		RC-AR406	0530
1,8	88	09.76 - 12.85	AR01678	4		RC-AR406	0530
1,8	90	03.73 - 04.82	AR01608	4		RC-AR406	0530
1,8 GT	90	09.77 - 04.81	AR01608	4		RC-AR406	0530
2,0	89	08.72 - 04.82	AR01623	4		RC-AR406	0530
2,0	89	07.76 - 10.84	AR01623	4		RC-AR406	0530
2,0 GTV	94	11.84 - 06.88	AR06212	4		RC-AR406	0530
2,0	96	09.78 - 12.85	AR01655	4		RC-AR406	0530
2,0	96	09.78 - 10.84	AR01655	4		RC-AR406	0530
2,0	96	09.83 - 12.85	AR01713	4		RC-AR406	0530

Arna

1,2	46	03.83 - 02.87	AR30102	4		RC-AR403	0527
1,2	50	10.84 - 02.87	AR30500	4		RC-AR403	0527
1,3	63	10.84 - 02.87	AR30168	4		RC-AR403	0527
1,5	70	10.84 - 02.87	AR30182	4		RC-AR403	0527

Giulietta

1,3	66	07.77 - 05.83	AR01644	4		RC-AR406	0530
1,6	80	07.77 - 07.85	AR01600	4		RC-AR406	0530
1,8	88	10.77 - 07.85	AR01678	4		RC-AR406	0530
1,8	110	04.83 - 06.86	AR01354	4		RC-AR406	0530
2,0	96	10.77 - 12.85	AR01655	4		RC-AR406	0530
2,0	125	04.83 - 06.85	AR01699	4		RC-AR406	0530

GT

1,8 Twin Spark	103	11.03 -	AR32205	4		RC-AR1102	44255
----------------	-----	---------	---------	---	--	-----------	-------

GTV

1,8 Twin Spark	103	09.97 - 03.03	AR32201	4		RC-AR903	8597
2,0 Twin Spark	110	09.00 -	AR32310	4		RC-AR1102	44255
2,0 Twin Spark	114	09.97 - 08.00	AR32301	4		RC-AR903	8597
2,0 V6 Turbo	148	06.95 - 01.01	AR16202	4		RC-AR205	0524



kW

C
y
l

Stock-No.

ALFA ROMEO**Spider**

1,8 Twin Spark	103	09.97 - 03.03	AR32201	4		RC-AR903	8597
2,0	93	01.85 - 12.89	AR00515	4		RC-AR406	0530
2,0 Twin Spark	110	03.95 - 08.97	AR16201	4		RC-AR903	8597
2,0 Twin Spark	110	10.00 - 09.03	AR16201	4		RC-AR1102	44255
2,0 Twin Spark	114	09.97 - 08.00	AR32301	4		RC-AR903	8597
3,0	141	03.95 - 08.01	AR16101	6		RC-AR917	7312

Sprint

1,7	77	03.87 - 08.90	AR30558	4		RC-AR403	0527
1,7	87	03.87 - 08.90	AR30550	4		RC-AR403	0527

SZ

3,0	152	09.89 - 02.92	AR61501	6		RC-AR201	0520
-----	-----	---------------	---------	---	--	----------	------

AUDI**50**

1,1	37	08.74 - 12.78	HD	4		RC-VW1102	2569
1,1	37	08.74 - 12.78	HB	4		RC-VW1102	2569
1,1	44	08.74 - 07.77	HC	4		RC-VW1102	2569
1,3	44	08.77 - 12.78	HH	4		RC-VW1102	2569

80

1,3	40	09.78 - 07.81	FY	4		RC-AD1104	2579
1,3	44	08.81 - 08.86	EP	4		RC-AD1104	2579
1,3	44	08.81 - 08.86	EP	4		RC-VW210	0941
1,6	51	03.87 - 08.91	PP	4		RC-VW210	0941
1,6	52	09.91 - 12.94	ABM	4		RC-AD210	0510
1,6	53	08.85 - 08.86	SA	4		RC-VW210	0941
1,6	55	08.83 - 08.86	WV	4	08.84>	RC-AD1104	2579
1,6	55	08.83 - 08.86	DT	4	08.84>	RC-VW242	8262
1,6	55	09.86 - 08.91	RN	4		RC-VW210	0941
1,6	63	05.72 - 12.82	YP	4		RC-AD1104	2579
1,6	75	08.93 - 07.96	ADA	4		RC-AD202	0502
1,6	81	09.78 - 05.84	YZ	4		RC-AD1104	2579
1,8	55	09.86 - 08.91	RU	4		RC-VW210	0941
1,8	64	08.85 - 07.90	SF	4		RC-VW210	0941
1,8 Quattro	64	09.86 - 07.90	SF	4		RC-VW210	0941
1,8	66	08.81 - 08.86	DS	4		RC-VW210	0941
1,8 Quattro	66	08.84 - 08.86	NE	4		RC-AD210	0510
1,8	66	09.86 - 08.91	PM	4		RC-VW210	0941
1,8	66	09.86 - 07.89	NE	4		RC-AD210	0510
1,8 Quattro	66	09.86 - 07.89	NE	4		RC-AD202	0502
1,8	66	08.89 - 08.91	NE	4		RC-AD202	0502
1,8 Quattro	66	08.90 - 08.91	PM	4		RC-VW210	0941
1,8	68	06.84 - 08.91	JN	4		RC-VW210	0941
1,8 Quattro	68	08.84 - 07.90	JN	4		RC-VW210	0941
1,8	82	08.81 - 08.91	DZ	4		RC-VW210	0941
1,8	82	06.84 - 08.86	PV	4		RC-VW210	0941
1,8 Quattro	82	08.84 - 08.86	PV	4		RC-VW210	0941
1,8 Quattro	82	08.84 - 08.91	DZ	4		RC-VW210	0941
1,9	83	09.86 - 07.88	SD	4		RC-VW210	0941
1,9 Quattro	83	09.86 - 07.88	SD	4		RC-VW210	0941
1,9	85	08.81 - 07.83	WN	5		RC-AD212	0512
2,0	66	09.91 - 01.96	ABT	4		RC-VW242	8262
2,0	83	08.88 - 08.91	3A	4		RC-VW242	8262
2,0 Quattro	83	08.88 - 07.90	3A	4		RC-VW242	8262
2,0 Quattro	85	08.82 - 07.84	JS	5		RC-AD212	0512



kW

C
y
I

Stock-No.

AUDI**80**

2.0	85	08.83 - 05.84	HP	5		RC-AD212	0512
2.0	85	08.83 - 05.84	JS	5		RC-AD212	0512
2.0	85	08.89 - 07.92	AAD	4		RC-VW242	8262
2.0 Quattro	85	08.90 - 07.92	AAD	4		RC-VW242	8262
2.0	85	09.91 - 07.93	ABK	4		RC-VW242	8262
2.0 Quattro	85	09.91 - 07.94	ABK	4		RC-VW242	8262
2.0	101	08.89 - 07.92	6A	4		RC-AD205	0505
2.0 Quattro	101	08.89 - 07.92	6A	4		RC-AD205	0505
2.0	103	08.92 - 07.96	ACE	4		RC-AD1101	7709
2.0 Quattro	103	08.92 - 07.96	ACE	4		RC-AD1101	7709
2,1	85	09.78 - 07.83	WE	5		RC-AD212	0512
2,3	98	09.91 - 12.94	NG	5		RC-AD216	0516
2,3 Quattro	98	09.91 - 07.94	NG	5		RC-AD216	0516
2,6	110	08.92 - 07.95	ABC	6		RC-AD204	0504
2,6 Quattro	110	08.92 - 07.96	ABC	6		RC-AD204	0504
2,8	128	09.91 - 01.96	AAH	6		RC-AD204	0504
2,8 Quattro	128	09.91 - 07.96	AAH	6		RC-AD204	0504

90

2.0	85	05.84 - 03.87	HP	5		RC-AD216	0516
2.0	85	05.84 - 03.87	JS	5		RC-AD216	0516
2.0	83	03.86 - 03.86	SK	5		RC-AD216	0516
2.0	85	04.87 - 08.91	PS	5		RC-AD216	0516
2.0 Quattro	118	09.86 - 12.91	NM	5		RC-AD208	0508
2.0	118	04.87 - 08.91	NM	5		RC-AD208	0508
2,2	85	05.84 - 03.87	KX	5		RC-AD211	0511
2,2 Quattro	89	08.84 - 08.86	JT	5		RC-AD216	0516
2,2	100	05.84 - 08.91	KV	5		RC-AD216	0516
2,2	100	05.84 - 03.87	HY	5		RC-AD216	0516
2,2 Quattro	100	08.84 - 08.91	KV	5		RC-AD216	0516
2,3 Quattro	98	09.86 - 08.91	NG	5		RC-AD216	0516
2,3	98	04.87 - 08.91	NG	5		RC-AD216	0516
2,3 Quattro	125	09.86 - 12.91	7A	5		RC-AD208	0508
2,3	125	04.87 - 08.91	7A	5		RC-AD208	0508

100

1,6	63	09.74 - 05.76	YM	4		RC-VW218	0949
1,6	63	06.76 - 07.82	YV	4		RC-VW1101	2565
1,8	55	08.82 - 12.87	DR	4	>08.86	RC-VW242	8262
1,8	55	08.82 - 12.87	DR	4	>06.84	RC-VW1101	2565
1,8	55	08.82 - 12.87	DR	4	08.84>	RC-AD209	0509
1,8	55	08.86 - 12.87	RS	4		RC-AD209	0509
1,8 Quattro	65	08.85 - 11.90	SH	4		RC-AD209	0509
1,8	65	08.86 - 11.90	SH	4		RC-AD209	0509
1,8	66	08.82 - 07.89	DS	4	>08.86	RC-VW242	8262
1,8	66	08.82 - 07.89	JW	4	>08.86	RC-VW242	8262
1,8	66	08.82 - 07.89	DS	4	>06.84	RC-VW1101	2565
1,8	66	08.82 - 07.86	DS	4	08.84>	RC-AD209	0509
1,8	66	08.82 - 07.89	JW	4	08.84>	RC-AD209	0509
1,8	66	08.84 - 11.90	PH	4		RC-AD209	0509
1,8 Quattro	66	09.84 - 12.87	JW	4	>08.86	RC-VW242	8262
1,8 Quattro	66	09.84 - 11.90	4B	4		RC-AD209	0509
1,8 Quattro	66	09.84 - 11.90	NP	4		RC-AD209	0509
1,8 Quattro	66	09.84 - 11.90	PH	4		RC-AD209	0509
1,8 Quattro	66	09.84 - 12.87	JW	4	08.84>	RC-AD209	0509
1,8	66	08.86 - 07.89	DS	4		RC-AD209	0509
1,8	66	01.88 - 11.90	NP	4		RC-AD209	0509
1,8	66	01.88 - 11.90	4B	4		RC-AD209	0509
1,9	74	08.79 - 07.84	WH	5		RC-AD1103	2568



kW

C
y
l

Stock-No.

**AUDI
100**

2,0	74	08.91 - 07.94	AAE	4		RC-AD219	0519
2,0	85	08.84 - 12.87	KP	5		RC-AD211	0511
2,0	85	08.86 - 12.87	SL	5		RC-AD216	0516
2,0	85	01.88 - 11.90	RT	5		RC-AD211	0511
2,0	85	08.91 - 07.94	AAD	4		RC-AD202	0502
2,0 Quattro	85	08.91 - 07.92	AAD	4		RC-AD202	0502
2,0	85	01.93 - 07.93	ABK	4		RC-AD202	0502
2,0	103	08.92 - 07.94	ACE	4		RC-AD1101	7709
2,0 Quattro	103	08.92 - 07.94	ACE	4		RC-AD1101	7709
2,1	85	06.76 - 07.82	WB	5		RC-AD1103	2568
2,1	85	06.76 - 07.82	WE	5		RC-AD1103	2568
2,1	96	08.82 - 07.84	KF	5		RC-AD1103	2568
2,1	100	06.76 - 07.84	WC	5		RC-AD1103	2568
2,1	100	06.76 - 07.80	WG	5		RC-AD1103	2568
2,2	85	08.84 - 12.87	KZ	5		RC-AD216	0516
2,2 Quattro	88	08.85 - 12.87	PX	5		RC-AD211	0511
2,2	101	08.84 - 07.90	KU	5		RC-AD216	0516
2,2 Quattro	101	09.84 - 11.90	KU	5		RC-AD216	0516
2,2	121	08.85 - 07.90	MC	5		RC-AD216	0516
2,2 Quattro	121	08.85 - 07.87	MC	5		RC-AD216	0516
2,3	98	08.91 - 07.94	AAR	5		RC-AD216	0516
2,3 Quattro	98	08.91 - 07.94	AAR	5		RC-AD216	0516
2,3	100	08.86 - 11.90	NF	5		RC-AD216	0516
2,3 Quattro	100	08.86 - 07.91	NF	5		RC-AD216	0516
2,6	102	11.93 - 07.94	ACZ	6		RC-AD204	0504
2,6	110	08.92 - 07.94	ABC	6		RC-AD204	0504
2,6 Quattro	110	08.92 - 07.94	ABC	6		RC-AD204	0504
2,8	128	08.91 - 07.94	AAH	6		RC-AD204	0504
2,8 Quattro	128	08.91 - 07.94	AAH	6		RC-AD204	0504
4,2 Quattro	206	10.92 - 07.93	ABH	8		RC-AD206	0506
4,2 Quattro	213	03.94 - 07.94	AEC	8		RC-AD206	0506

200

2,1	100	10.79 - 09.84	WC	5		RC-AD212	0512
2,1	125	10.79 - 07.83	WJ	5		RC-AD212	0512
2,1	134	08.83 - 12.87	KG	5		RC-AD216	0516
2,1 Quattro	134	10.84 - 01.87	KG	5		RC-AD216	0516
2,2	101	08.83 - 07.85	KU	5		RC-AD216	0516
2,2 Quattro	121	11.84 - 11.90	MC	5		RC-AD216	0516
2,2	121	01.85 - 12.90	MC	5		RC-AD216	0516
2,2	140	01.88 - 12.90	2B	5		RC-AD211	0511
2,2	147	01.88 - 12.90	1B	5		RC-AD211	0511
2,2 Quattro	147	02.88 - 11.90	1B	5		RC-AD211	0511
2,2 Quattro	162	03.89 - 11.90	3B	5		RC-AD207	0507
2,3	100	08.86 - 12.87	NF	5		RC-AD211	0511

A1

1,2	63	05.10 -	CBZA	4		RC-VW1110	44316
-----	----	---------	------	---	--	-----------	-------

A2

1,4	55	03.00 - 02.02	AUA	4		RC-VW910	7306
1,4	55	05.02 - 08.05	BBY	4		RC-VW1111	44328

A3

1,2	77	01.10 -	CBZB	4		RC-VW1110	44316
1,6	74	07.96 - 06.01	AEH	4		RC-VW203	0934
1,6	74	09.97 - 06.01	AKL	4		RC-VW203	0934
1,6	74	07.99 - 08.00	APF	4		RC-VW203	0934
1,6	75	09.00 - 04.02	AVU	4		RC-VW254	7044



kW

C
y
l

Stock-No.

AUDI**A3**

1,6	75	05.03 - 05.05	BGU	4		RC-VW254	7044
1,6	75	07.08 -	CCSA	4		RC-VW254	7044
1,6	75	06.05 -	BSF	4		RC-VW254	7044
1,6	75	05.10 -	CMXA	4		RC-VW254	7044
1,6	75	06.05 -	BSE	4		RC-VW254	7044
1,6	75	05.02 - 05.03	BFQ	4		RC-VW254	7044
1,8	92	07.96 - 06.99	AGN	4	>Chassis No 8L-V-140001	RC-AD201	0501
1,8	92	07.99 - 08.00	AGN	4	Chassis No 8L-V-140001>	RC-VW236	0967
1,8	92	09.00 - 05.03	APG	4	Chassis No 8L-V-140001>	RC-VW236	0967

A4

1,6	74	10.94 - 07.97	ADP	4		RC-AD215	0515
1,6	74	10.96 - 07.99	AHL	4		RC-VW254	7044
1,6	74	03.99 - 09.00	ARM	4		RC-VW254	7044
1,6	74	08.99 - 09.00	ANA	4		RC-VW254	7044
1,6	75	06.00 - 10.04	ALZ	4		RC-VW254	7044
1,8	92	10.94 - 07.99	ADR	4	Semi-Direct	RC-AD1102	2348
1,8 Quattro	92	11.94 - 07.99	ADR	4	Semi-Direct	RC-AD1102	2348
1,8	92	03.99 - 09.00	APT	4	Semi-Direct	RC-AD1102	2348
1,8	92	03.99 - 09.00	ARG	4	Semi-Direct	RC-AD1102	2348
1,8	92	06.00 - 09.00	AVV	4	Semi-Direct	RC-AD1102	2348
2,4	121	08.97 - 02.99	ALF	6		RC-AD218	0518
2,4	121	08.97 - 02.99	AGA	6		RC-AD218	0518
2,4	121	03.99 - 09.00	ARJ	6		RC-AD218	0518
2,4 Quattro	121	03.99 - 07.99	ARJ	6		RC-AD218	0518
2,4	121	03.99 - 08.99	APS	6		RC-AD218	0518
2,4	121	05.99 - 09.00	AML	6		RC-AD218	0518
2,4	120	09.01 - 12.04	AMM	6		RC-AD218	0518
2,4	125	09.01 - 12.04	BDV	6		RC-AD218	0518
2,6	110	07.97 - 02.99	ABC	6		RC-AD218	0518
2,8	128	10.94 - 07.97	AAH	6		RC-AD204	0504
2,8 Quattro	128	11.94 - 07.97	AAH	6		RC-AD204	0504
2,8 Quattro	142	01.96 - 02.99	ACK	6		RC-AD218	0518
2,8	142	03.96 - 02.99	ACK	6		RC-AD218	0518
2,8 Quattro	142	08.97 - 02.99	ALG	6		RC-AD218	0518
2,8	142	08.97 - 02.99	ALG	6		RC-AD218	0518
2,8 Quattro	142	03.99 - 07.99	APR	6		RC-AD218	0518
2,8 Quattro	142	03.99 - 09.00	AQD	6		RC-AD218	0518
2,8	142	03.99 - 07.99	APR	6		RC-AD218	0518
2,8	142	03.99 - 09.00	AQD	6		RC-AD218	0518
2,8 Quattro	142	08.99 - 09.00	AMX	6		RC-AD218	0518
2,8	142	08.99 - 09.00	AMX	6		RC-AD218	0518

A6

2,0	74	06.94 - 07.96	AAE	4		RC-AD202	0502
2,0	85	06.94 - 07.96	ABK	4		RC-AD202	0502
2,0	103	06.94 - 01.98	ACE	4		RC-AD1101	7709
2,0 Quattro	103	06.94 - 07.96	ACE	4		RC-AD1101	7709
2,3	98	06.94 - 07.96	AAR	5		RC-AD211	0511
2,3 Quattro	98	06.94 - 07.95	AAR	5		RC-AD211	0511
2,4	100	08.97 - 01.99	ALW	6		RC-AD218	0518
2,4	100	01.99 - 05.00	ARN	6		RC-AD218	0518
2,4	100	06.00 - 07.04	ASM	6		RC-AD218	0518
2,4	115	04.98 - 07.98	APC	6		RC-AD204	0504
2,4	121	05.97 - 12.98	ALF	6		RC-AD218	0518
2,4	121	05.97 - 12.98	AGA	6		RC-AD218	0518
2,4 Quattro	121	05.97 - 12.98	ALF	6		RC-AD218	0518
2,4 Quattro	121	05.97 - 12.98	AGA	6		RC-AD218	0518
2,4 Quattro	121	08.97 - 02.99	AGA	6		RC-AD218	0518



kW

C
y
l

Stock-No.

AUDI**A6**

2,4 Quattro	121	08.97 - 02.99	ALF	6		RC-AD218	0518
2,4	121	01.99 - 05.01	ARJ	6		RC-AD218	0518
2,4	121	01.99 - 05.00	APS	6		RC-AD218	0518
2,4 Quattro	121	01.99 - 05.01	ARJ	6		RC-AD218	0518
2,4 Quattro	121	01.99 - 05.00	APS	6		RC-AD218	0518
2,4 Quattro	121	05.00 - 05.01	AML	6		RC-AD218	0518
2,4	121	06.00 - 05.01	AML	6		RC-AD218	0518
2,4	125	08.01 - 01.05	BDV	6		RC-AD218	0518
2,6	110	06.94 - 04.97	ABC	6		RC-AD204	0504
2,6 Quattro	110	06.94 - 04.97	ABC	6		RC-AD204	0504
2,8	128	06.94 - 04.97	AAH	6		RC-AD204	0504
2,8 Quattro	128	06.94 - 04.97	AAH	6		RC-AD204	0504
2,8	142	08.95 - 12.98	ACK	6		RC-AD218	0518
2,8 Quattro	142	08.95 - 12.98	ACK	6		RC-AD218	0518
2,8	142	05.97 - 12.98	ALG	6		RC-AD218	0518
2,8 Quattro	142	05.97 - 12.98	ALG	6		RC-AD218	0518
2,8	142	01.99 - 07.99	APR	6		RC-AD218	0518
2,8	142	01.99 - 05.00	AQD	6		RC-AD218	0518
2,8 Quattro	142	01.99 - 07.99	APR	6		RC-AD218	0518
2,8 Quattro	142	01.99 - 05.00	AQD	6		RC-AD218	0518
2,8 Quattro	142	05.00 - 05.01	AMX	6		RC-AD218	0518
2,8	142	06.00 - 05.01	AMX	6		RC-AD218	0518

A8

2,8	128	06.94 - 02.96	AAH	6		RC-AD204	0504
2,8 Quattro	128	09.94 - 03.96	AAH	6		RC-AD204	0504
2,8 Quattro	142	07.95 - 09.98	ACK	6		RC-AD218	0518
2,8	142	03.96 - 09.97	ACK	6		RC-AD218	0518
2,8	142	10.97 - 02.01	APR	6		RC-AD218	0518
2,8	142	10.97 - 09.98	ALG	6		RC-AD218	0518
2,8	142	10.98 - 02.01	AQD	6		RC-AD218	0518
2,8 Quattro	142	10.98 - 07.00	AQD	6		RC-AD218	0518
2,8 Quattro	142	10.98 - 07.00	APR	6		RC-AD218	0518
2,8	142	05.00 - 07.02	AMX	6		RC-AD218	0518
2,8 Quattro	142	05.00 - 10.02	AMX	6		RC-AD218	0518

Cabriolet

2,0	85	01.93 - 10.98	ABK	4		RC-VW207	0938
2,0	103	05.95 - 07.96	ACE	4		RC-AD205	0505
2,3	98	05.91 - 07.94	NG	5		RC-AD216	0516
2,4	125	04.02 - 12.05	BDV	6		RC-AD218	0518
2,6	110	08.93 - 07.02	ABC	6		RC-AD204	0504
2,8	128	11.92 - 08.00	AAH	6		RC-AD204	0504

Coupe

1,8	64	08.84 - 07.88	SF	4		RC-AD210	0510
1,8	66	08.82 - 07.88	DS	4		RC-AD209	0509
1,8	66	08.84 - 07.87	JV	4		RC-AD209	0509
1,8	68	08.84 - 07.88	JN	4		RC-AD209	0509
1,8	82	08.86 - 07.91	DZ	4		RC-AD209	0509
1,8	82	08.86 - 07.88	PV	4		RC-AD209	0509
1,9	85	10.80 - 07.83	WN	5		RC-AD212	0512
2,0	83	02.86 - 04.88	SK	5		RC-AD211	0511
2,0	83	08.89 - 07.91	3A	4		RC-VW207	0938
2,0	85	08.83 - 07.86	JS	5		RC-AD216	0516
2,0	85	08.83 - 07.86	HP	5		RC-AD216	0516
2,0	85	08.91 - 05.96	ABK	4		RC-VW207	0938
2,0	101	08.91 - 07.92	6A	4		RC-AD205	0505



kW

C
y
l

Stock-No.

AUDI**Coupe**

2,0	103	08.92 - 06.96	ACE	4		RC-AD205	0505
2,0 Quattro	118	11.88 - 07.91	NM	5		RC-AD208	0508
2,1	79	10.80 - 07.82	WE	5		RC-AD212	0512
2,1	96	08.81 - 07.84	KE	5		RC-AD216	0516
2,1	96	09.82 - 08.84	KL	5		RC-AD216	0516
2,2	85	08.84 - 07.88	KX	5		RC-AD216	0516
2,2 Quattro	89	08.86 - 07.88	JT	5		RC-AD216	0516
2,2	100	08.84 - 07.92	KV	5		RC-AD216	0516
2,2 Quattro	100	08.86 - 07.91	KV	5		RC-AD216	0516
2,2 Quattro	162	08.90 - 09.92	3B	5		RC-AD207	0507
2,2	162	08.92 - 07.94	3B	5		RC-AD207	0507
2,3	98	08.86 - 07.94	NG	5		RC-AD208	0508
2,3 Quattro	98	08.86 - 07.94	NG	5		RC-AD208	0508
2,3	125	08.88 - 07.90	7A	5		RC-AD208	0508
2,3 Quattro	125	08.88 - 07.91	7A	5		RC-AD208	0508
2,6	110	08.91 - 05.96	ABC	6		RC-AD204	0504
2,6 Quattro	110	08.92 - 04.95	ABC	6		RC-AD204	0504
2,8	128	08.91 - 05.96	AAH	6		RC-AD204	0504
2,8 Quattro	128	08.91 - 12.96	AAH	6		RC-AD204	0504

TT

1,8	132	10.99 - 06.06	APP	4		RC-AD201	0501
-----	-----	---------------	-----	---	--	----------	------

Quattro

2,1	147	07.80 - 07.87	GV	5		RC-AD1103	2568
2,1	147	07.80 - 07.87	WR	5		RC-AD1103	2568

S6

4,2 Quattro	213	06.94 - 04.97	AEC	8		RC-AD206	0506
-------------	-----	---------------	-----	---	--	----------	------

AUSTIN**1100**

1,1	37	10.62 - 09.67	10A	4		RC-AT405	0543
1,1	38	10.67 - 09.75	10H	4		RC-AT405	0543

1300

1,3	44	10.67 - 09.74	12H	4		RC-AT405	0543
1,3	55	10.68 - 09.74	12H1	4		RC-AT405	0543

Allegro

1,0	34	02.81 - 12.84	99H	4		RC-AT405	0543
1,1	33	02.73 - 11.79	10L	4		RC-AT405	0543
1,1	36	02.73 - 11.79	10H	4		RC-AT405	0543
1,1	48	12.79 - 12.84	10L	4		RC-AT405	0543
1,1	48	12.79 - 12.84	10H	4		RC-AT405	0543
1,3	41	02.73 - 11.79	12L	4		RC-AT405	0543
1,3	43	12.79 - 12.84	12L	4		RC-AT405	0543
1,3	46	12.79 - 12.84	12H	4		RC-AT405	0543
1,5	51	02.73 - 11.79	14H	4		RC-AT405	0543
1,5	51	08.73 - 11.79	14L	4		RC-AT405	0543
1,5	52	08.75 - 12.84	14L	4		RC-AT405	0543
1,5	56	08.75 - 12.84	14H	4		RC-AT405	0543
1,7	50	10.79 - 12.84	17HL	4		RC-AT402	0540
1,7	63	08.73 - 11.79	17H	4		RC-AT402	0540
1,7	67	08.75 - 12.84	17H	4		RC-AT402	0540
1,7	75	08.73 - 11.79	17H	4		RC-AT402	0540



kW

C
y
l

Stock-No.

AUSTIN**Ambassador**

1,7	62	03.82 - 06.85	17L	4		RC-AT402	0540
1,7	65	03.82 - 06.85	17HL	4		RC-AT402	0540

Maestro

1,3	46	03.83 - 12.85	12L	4		RC-AT402	0540
1,3	47	01.86 - 09.92	12HEK	4		RC-AT402	0540
1,3	47	01.86 - 09.92	12HK	4		RC-AT402	0540
1,3	50	01.86 - 09.92	12HE	4		RC-AT402	0540
1,6	59	03.83 - 12.85	16H	4		RC-AT404	0542
1,6	61	01.86 - 09.92	16H	4		RC-AT404	0542
2,0	83	10.84 - 10.90	20HC5	4		RC-AT404	0542

Maxi

1,5	51	03.70 - 12.80	14H	4		RC-AT402	0540
1,7	54	10.71 - 12.81	17H	4		RC-AT402	0540
1,7	67	10.80 - 12.82	17H	4		RC-AT402	0540

Metro

1,0	35	10.84 - 09.87	10HL	4		RC-AT405	0543
1,3	46	10.84 - 03.90	12HL	4		RC-AT405	0543
1,3	49	10.84 - 03.90	12HH	4		RC-AT405	0543
1,3	52	12.88 - 03.90	12HH9	4		RC-AT405	0543
1,3	66	10.84 - 03.90	12HA5	4		RC-AT405	0543

Mini

0,8	22	09.69 - 09.73	A8H	4		RC-AT405	0543
0,8	25	09.69 - 10.85	85H	4		RC-AT405	0543
0,8	27	06.59 - 08.69	8F	4		RC-AT405	0543
1,0	27	10.80 - 10.85	99H024	4		RC-AT405	0543
1,0	28	09.69 - 09.80	99H	4		RC-AT405	0543
1,0	29	10.80 - 07.90	99H025	4		RC-AT405	0543
1,0	29	10.85 - 10.88	99L	4		RC-AT405	0543
1,0	31	10.80 - 12.83	99HL	4		RC-AT405	0543
1,0	31	10.80 - 07.90	99H026	4		RC-AT405	0543
1,0	34	10.80 - 10.85	99H027	4		RC-AT405	0543
1,0	35	10.80 - 09.84	99H	4		RC-AT405	0543
1,0	40	11.62 - 08.64	9FX	4		RC-AT405	0543
1,0	44	09.62 - 08.69	9FD	4		RC-AT405	0543
1,1	33	09.69 - 09.80	10H	4		RC-AT405	0543
1,1	46	11.62 - 08.64	9FN	4		RC-AT405	0543
1,3	40	09.69 - 09.74	12H	4		RC-AT405	0543
1,3	41	09.69 - 09.74	12H	4		RC-AT405	0543
1,3	46	10.80 - 09.84	12HL	4		RC-AT405	0543
1,3	48	04.74 - 09.80	12H	4		RC-AT405	0543
1,3	53	09.69 - 09.80	12HC	4		RC-AT405	0543
1,3	57	09.62 - 08.69	9FE	4		RC-AT405	0543

Montego

1,3	46	04.84 - 12.85	12HL	4		RC-AT402	0540
1,3	50	01.86 - 12.90	12HL	4		RC-AT402	0540
1,6	61	04.84 - 09.92	16HL	4		RC-AT404	0542
2,0	76	04.84 - 09.92	20HL	4		RC-AT404	0542
2,0	83	12.88 - 09.92	20HE	4		RC-AT404	0542
2,0	86	04.84 - 12.85	20HE	4		RC-AT404	0542
2,0	110	10.84 - 12.85	20HCT	4		RC-AT404	0542

Princess

1,8	56	02.74 - 08.78	18H	4		RC-AT404	0542
2,2	80	09.78 - 09.82	22H	6		RC-CR304	8286



kW

C
y
i

Stock-No.

AUTOBIANCHI**A112**

0,9	29	11.81 - 08.85	A112B2000	4		RC-LC403	0722
0,9	32	09.69 - 08.85	A112A5000	4		RC-LC403	0722
1,0	35	12.77 - 06.83	A112B1000	4		RC-LC403	0722
1,0	43	09.69 - 01.79	A112A1000	4		RC-LC403	0722
1,1	52	03.75 - 08.85	A112A2000	4		RC-LC403	0722

Y10

1,0	33	05.85 - 12.92	156A2000	4		RC-LC615	7207
1,0	33	07.89 - 12.92	156A2246	4		RC-LC615	7207
1,0	37	05.85 - 06.89	156A3000	4		RC-LC615	7207
1,0	41	05.85 - 09.87	156A000	4		RC-LC614	7206
1,0	62	05.85 - 06.89	156A1000	4		RC-LC607	8502
1,1	42	07.89 - 09.94	156C000	4		RC-LC615	7207
1,3	54	10.86 - 06.89	146A5046	4		RC-LC616	7208
1,3	57	10.86 - 12.92	156B000	4		RC-LC616	7208

BEDFORD (GM)**Astra**

1,3	44	09.84 - 09.89	13NB	4		RC-OP455	0825
1,3	44	09.86 - 08.89	13NB	4		RC-OP408	0778
1,3	55	08.82 - 09.89	13S	4		RC-OP455	0825
1,6	66	09.84 - 08.87	16S	4		RC-OP402	0772
1,6	66	09.87 - 08.91	16SV	4	SAE fitment	RC-OP455	0825
1,6	66	09.87 - 08.91	16SV	4	M4 fitment	RC-OP436	0806

Astramax

1,3	44	09.85 - 06.90	13NB	4		RC-OP408	0778
-----	----	---------------	------	---	--	----------	------

Rascal

1,0	34	06.86 - 06.90	FA10A	4		RC-OP403	0773
-----	----	---------------	-------	---	--	----------	------

BMW**BMW 3**

315 1,6	55	04.81 -1984-03	M10B16	4		RC-BW231	0575
316 1,6	66	06.75 - 08.80	M10B16A	4		RC-BW1201	5503
316i 1,6	73	05.87 - 10.94	M40 B16C	4		RC-BW210	0553
316i 1,6	73	05.87 - 08.90	M40 B16C	4	08.88>	RC-BW222	0565
316i 1,6	75	09.90 - 09.93	M43 B164E2	4		RC-BW210	0553
316i 1,6	75	03.93 - 05.01	M43 B164E2	4		RC-BW208	0551
316 1,8	66	06.80 - 07.88	M10 B18A	4		RC-BW231	0575
316i 1,8	75	05.87 - 08.88	M10 B18B	4		RC-BW231	0575
316i 1,8	77	05.87 - 08.88	M10 B18F	4		RC-BW231	0575
316i 1,9	77	08.98 - 06.01	M43 B164E3	4		RC-BW235	0579
318 1,8	72	06.75 - 08.82	M10 B18D	4		RC-BW1201	5503
318i 1,8	75	10.79 - 07.80	M10 B18B	4		RC-BW1201	5503
318i 1,8	77	09.80 - 09.88	M10 B18F	4		RC-BW231	0575
318i 1,8	83	09.88 - 10.94	M40 B18C	4		RC-BW210	0553
318i 1,8	83	09.90 - 10.93	M40 B184E1	4		RC-BW210	0553
318i 1,8	85	01.87 - 11.90	M40 B18E	4		RC-BW210	0553
318i 1,8	85	10.87 - 01.89	M40 B18C	4		RC-BW210	0553
318i 1,8	85	08.93 - 11.99	M43 B184E2	4		RC-BW235	0579
318i 1,8	85	11.94 - 07.99	M43 B184E2	4		RC-BW235	0579
318i 1,8	103	03.88 - 10.89	M42 B18E	4		RC-BW225	0569
318i 1,8	103	06.88 - 02.92	M40 B18C	4		RC-BW210	0553
318i 1,8	103	02.89 - 08.90	M42 B18C	4		RC-BW225	0569
318i 1,8	103	06.91 - 08.96	M42 B184S1	4		RC-BW205	0548
318i 1,9	87	02.98 - 06.01	M43 B194E1	4		RC-BW235	0579
318i 1,9	87	10.99 - 08.01	M43 B194E3	4		RC-BW235	0579



kW

C
y
l

Stock-No.

BMW**BMW 3**

318i 1,9	103	04.95 - 09.99	M44 B194S1	4		RC-BW205	0548
320 2,0	80	07.75 - 08.82	M10 B20A	4		RC-BW1201	5503
320i 2,0	92	06.75 - 08.82	M10 B20E	4		RC-BW1201	5503
320i 2,0	95	09.82 - 08.90	M20 B20E	6	>08.88	RC-BW232	0576
320i 2,0	95	09.83 - 08.90	M20 B20E	6	09.89>	RC-BW230	0574
320i 2,0	95	02.86 - 08.93	M20 B20E	6		RC-BW232	0576
320i 2,0	95	06.86 - 10.94	M20 B20C	6	>08.88	RC-BW232	0576
320i 2,0	95	09.86 - 08.90	M20 B20C	6	09.89>	RC-BW230	0574
320i 2,0	95	09.88 - 10.94	M20 B20C	6		RC-BW232	0576
323i 2,3	105	01.78 - 08.82	M20 B23E	6		RC-BW232	0576
323i 2,3	110	09.82 - 12.86	M20 B23E	6		RC-BW232	0576
325i 2,5	125	01.86 - 10.94	M20 B25C	6		RC-BW218	0561
325i 2,5	126	05.85 - 08.90	M20 B25E	6		RC-BW218	0561
325e 2,7	90	10.83 - 10.87	M20 B27C	6		RC-BW230	0574

BMW 5

518 1,8	66	06.81 - 08.84	M1018	4		RC-BW231	0575
518i 1,8	77	07.84 - 11.87	M10B18F	4		RC-BW231	0575
518i 1,8	83	04.89 - 09.93	M40B18C	4		RC-BW213	0556
518i 1,8	85	11.92 - 10.94	M43184E2	4		RC-BW213	0556
520i 2,0	92	11.75 - 03.81	M20B20B	6		RC-BW232	0576
520i 2,0	92	04.81 - 07.83	M20B20E	6		RC-BW230	0574
520i 2,0	92	04.81 - 12.87	M20B20E	6		RC-BW218	0561
520i 2,0	92	09.81 - 04.86	M20B20E	6		RC-BW232	0576
520i 2,0	95	09.86 - 12.87	M20B20E	6		RC-BW230	0574
520i 2,0	95	01.88 - 10.89	M20B20E	6		RC-BW218	0561
525 2,5	106	10.73 - 08.76	M30B25A	6		RC-BW1101	2566
525 2,5	110	10.73 - 03.81	M30B25A	6		RC-BW1101	2566
525i 2,5	110	05.81 - 12.87	M30B25E	6		RC-BW1101	2566
525i 2,5	125	01.88 - 09.90	M20256K1	6		RC-BW218	0561
525e 2,7	90	09.81 - 11.87	M20B27E	6		RC-BW218	0561
525e 2,7	95	10.83 - 09.85	M20B27E	6		RC-BW218	0561
528i 2,8	135	08.79 - 11.87	M30B28F	6		RC-BW233	0577
530i 3,0	138	01.88 - 07.90	M30 B306KA	6		RC-BW223	0567
535i 3,5	155	01.88 - 09.95	M30 B35	6		RC-BW223	0567
535i 3,4	155	02.88 - 10.95	M30B35C	6		RC-BW223	0567
M535i 3,4	160	12.84 - 02.88	M30B35E	6		RC-BW223	0567
M5 3.5 3,5	211	08.85 - 12.87	S38B35	6		RC-BW223	0567

BMW 6

628csi 2,8	135	09.79 - 08.87	M30B28	6		RC-BW1101	2566
635csi 3,4	136	85.01 - 05.89	M30B35	6		RC-BW223	0567
635csi 3,4	141	04.85 - 09.90	M30B35	6		RC-BW223	0567
635i 3,4	155	01.85 - 10.89	M30B35C	6		RC-BW223	0567
635i 3,5	160	06.77 - 03.82	M30B35B	6		RC-BW1101	2566

BMW 7

728i 2,8	135	07.78 - 08.86	M30B28	6		RC-BW1101	2566
730i 3,0	138	07.86 - 06.94	M30B30D	6		RC-BW223	0567
730i 3,0	145	07.86 - 10.91	M30B30F	6		RC-BW223	0567
730i 3,0	145	07.86 - 10.92	M30B30C	6		RC-BW223	0567
732i 3,2	145	06.82 - 06.86	M30B32E	6		RC-BW230	0574
733i 3,2	145	05.77 - 09.79	M30 B 32	6		RC-BW223	0567
735i 3,4	155	07.86 - 08.92	M30B35C	6		RC-BW223	0567
735i 3,4	160	06.82 - 06.86	M30B35E	6		RC-BW230	0574
735i 3,4	160	07.86 - 12.88	M30B35D	6		RC-BW223	0567
745i 3,2	185	04.80 - 04.83	M30B32	6		RC-BW1108	44252
745i 3,4	185	05.83 - 08.86	M30B34E	6		RC-BW1104	44239



kW

C
y
I

Stock-No.

BMW**Z3**

1,8	85	10.95 - 10.98	M43 B184E2	4		RC-BW235	0579
1,9	87	10.98 - 10.02	M43 B194E1	4		RC-BW235	0579
1,9	103	10.95 - 10.99	M44 B194S1	4		RC-BW205	0548

CHEVROLET**Aveo**

1,2	53	06.03 -	B12S1	4		RC-DW1202	6020
1,2	53	06.03 -	F12S3	4		RC-DW1202	6020
1,2	55	04.08 -	B12D1	4		RC-DW1202	6020
1,2	62	04.08 -	B12D1	4		RC-DW1202	6020
1,4	69	03.06 -	F14D3	4		RC-DW302	8276
1,4	74	04.08 -	F14D4	4		RC-DW302	8276
1,5	62	01.05 - 05.08	F15S3	4		RC-GM1203	44277

Captiva

2,4	100	06.06 -	Z24SED	4		RC-OP440	0810
-----	-----	---------	--------	---	--	----------	------

Cruze

1,6	80	06.06 -	F16D3 / LXT	4		RC-DW302	8276
1,6	83	06.06 -	F16D4	4	BiFuel	RC-DW302	8276

Evanda

2,0	96	03.05 -	X20SED	4		RC-OP440	0810
-----	----	---------	--------	---	--	----------	------

Kalos

1,2	53	03.05 -	B12S1	4		RC-DW1202	6020
1,2	53	05.03 -	F12S3	4		RC-DW1202	6020
1,4	61	05.03 - 12.04	F14S3	4		RC-DW301	8275
1,4	69	05.03 - 12.04	F14D3	4		RC-DW302	8276

Lacetti

1,4	70	01.05 -	F14D3	4		RC-DW1203	6022
1,6	80	01.05 -	F16D3	4		RC-DW1203	6022
1,8	90	01.05 -	T18SED	4		RC-OP440	0810

Matiz

0,8	38	02.05 -	F8CV	3	> Chassis No 577030	RC-DW304	7367
0,8	38	02.05 -	F8CV	3	Chassis No 577031 >	RC-DW1207	44331
1,0		03.05 -	B10S	4		RC-DW1202	6020
1,0		03.05 -	B10S1	4		RC-DW1202	6020

Niva

1,7	59	01.02 - 12.07	VAZ-2120	4		RC-LD1201	4943
1,7	60	01.98 -	BA32123	4		RC-GM1201	9185

Nubira

1,4	70	01.05 -	F14D3	4		RC-DW1203	6022
1,6	75	02.05 -	A16DMS	4		RC-DW302	8276
1,6	80	03.05 -	F16D3	4		RC-DW1203	6022
1,8	90	03.05 -	T18SED	4		RC-OP440	0810

Rezzo

1,6	79	03.05 -	A16DMS	4		RC-DW302	8276
2,0	90	03.05 -	T20SED	4		RC-OP440	0810

Spark

0,8	37	05.05 -	F8CV	3		RC-DW1207	44331
-----	----	---------	------	---	--	-----------	-------

Tacuma

1,8		01.05 -	F18S2	4		RC-DW1204	6258
-----	--	---------	-------	---	--	-----------	------



kW

C
y
l

Stock-No.

CHRYSLER (USA)**Concorde**

3,0	180	01.92 - 12.04	-	6		RC-CR304	8286
-----	-----	---------------	---	---	--	----------	------

Daytona

3,0	100	10.92 - 09.94	EFA	6		RC-CR304	8286
-----	-----	---------------	-----	---	--	----------	------

Grand Voyager

2,4	108	04.01 -	EDZ	4		RC-CR1203	9170
2,4	111	02.97 - 03.01	EDZ	4		RC-CR1202	4058
3,0	100	10.87 - 09.90	EFA	6		RC-CR304	8286
3,3	112	10.89 - 09.94	EGA	6		RC-CR305	8287
3,3	116	10.95 - 03.01	EGA	6	Up to 01/97	RC-CR305	8287
3,3	120	10.94 - 09.95	EGA	6		RC-CR305	8287
3,3	128	04.01 -	EGA	6		RC-CR305	8287
3,8	122	10.95 - 09.97	EGH	6		RC-CR305	8287
3,8	131	10.97 - 03.01	EGH	6		RC-CR305	8287

Le Baron

3,0	105	10.89 - 09.95	EFA	6		RC-CR304	8286
-----	-----	---------------	-----	---	--	----------	------

Neon

2,0	97	10.00 - 10.04	ECH	4		RC-CR1202	4058
2,0	96	08.94 - 10.02	ECB	4		RC-CR606	7248
2,0	98	08.94 - 10.02	ECB	4		RC-CR1202	4058
2,0	107	08.94 - 09.99	ECC	4		RC-CR1202	4058

New Yorker

3,5	155	04.93 - 09.98	F01	6		RC-CR305	8287
-----	-----	---------------	-----	---	--	----------	------

PT Cruiser

1,6	85	11.01 - 12.10	EJD	4		RC-RV1301	2476
2,0	104	06.00 - 09.04	ECC	4		RC-CR1203	9170
2,4	105	05.04 - 12.10	EDZ			RC-CR1203	9170
2,4	110	06.00 - 09.04	EDZ			RC-CR1203	9170

Saratoga

3,0	100	10.91 - 09.95	EFA	6		RC-CR304	8286
3,0	104	10.89 - 09.91	EFA	6		RC-CR304	8286

Sebring

2,0	104	09.00 -	ECC	4		RC-CR1203	9170
2,4	112	09.00 -	EDZ			RC-CR1203	9170

Stealth

3,0	180	01.91 - 12.00	-	6		RC-CR304	8286
-----	-----	---------------	---	---	--	----------	------

Stratus

2,0	96	05.94 - 09.97	ECB	4		RC-CR606	7248
2,0	98	10.97 - 09.00	ECB	4		RC-CR1202	4058
2,4	112	12.95 - 09.00	EDZ			RC-CR606	7248
2,4	112	12.95 - 09.00	EDZ			RC-CR1301	44228

Voyager

2,0	98	10.95 - 03.01	ECB	4		RC-CR308	8290
2,4	108	04.01 -	EDZ	4		RC-CR1301	44228
2,4	111	10.95 - 03.01	EDZ	4	>01.97	RC-CR308	8290
2,4	111	10.95 - 03.01	EDZ	4	01.97>	RC-CR1301	44228
2,5	72	10.87 - 09.95	EDM	4		RC-CR309	8292
3,0	101	10.87 - 09.90	EFA	6		RC-CR304	8286
3,0	104	10.90 - 09.95	EFA	6		RC-CR304	8286
3,0	108	10.84 - 07.90	EFA	6		RC-CR304	8286
3,0	108	10.93 - 09.95	EFA	6		RC-CR304	8286
3,3	110	10.90 - 09.94	EGA	6		RC-CR305	8287
3,3	112	10.89 - 09.90	EGA	6		RC-CR305	8287



kW

C
y
l

Stock-No.

CHRYSLER (USA)**Voyager**

3,3	116	10.95 - 12.99	EGA	6		RC-CR1204	6864
3,3	116	01.00 - 03.01	EGA	6		RC-CR1302	44229
3,3	120	10.91 - 09.95	EGA	6		RC-CR305	8287
3,3	128	04.01 -	EGA	6		RC-CR1302	44229
3,8	131	01.95 - 03.00	EGH	6		RC-CR305	8287

CITROEN**2CV**

0,4	17	03.70 - 03.79	A79A53	2		RC-CT402	0583
0,6	20	04.79 - 04.89	M28664	2		RC-CT402	0583
0,6	21	10.81 - 04.89	A06665	2		RC-CT402	0583
0,6	21	09.88 - 12.90	M28635	2		RC-CT402	0583

Ami 8

0,6	24	08.68 - 12.77	M28663	2		RC-CT402	0583
-----	----	---------------	--------	---	--	----------	------

AX

1,0	32	09.86 - 07.92	C1A	4		RC-CT601	7371
1,0	32	01.87 - 07.92	C1A	4	SAE fitment: With Coil lead	RC-CT601	7371
1,0	32	01.87 - 07.92	C1A	4	M4 fitment	RC-CT615	7285
1,0	32	06.91 - 07.92	C1A	4	M4 fitment: 01.92>	RC-CT615	7285
1,0	33	09.86 - 07.92	C3A	4		RC-CT601	7371
1,0	33	06.91 - 07.92	C3A	4	M4 fitment: 01.92>	RC-CT615	7285
1,0	33	08.92 - 05.95	TU9	4		RC-CT615	7285
1,0	37	02.87 - 10.89	TU9M	4		RC-CT601	7371
1,0	37	08.92 - 04.97	TU9M	4	SAE fitment: With Coil lead	RC-CT601	7371
1,0	37	08.92 - 04.97	TU9M	4	M4 fitment	RC-CT615	7285
1,1	40	09.86 - 07.92	HAZ	4		RC-CT601	7371
1,1	40	09.86 - 07.92	H1A	4		RC-CT601	7371
1,1	40	08.92 - 04.94	TU1	4		RC-CT601	7371
1,1	44	09.86 - 07.92	HDZ	4		RC-CT601	7371
1,1	44	09.86 - 07.92	H1B	4		RC-CT601	7371
1,1	44	08.92 - 04.97	TU1M	4		RC-CT601	7371
1,3	69	12.86 - 07.92	M4A	4		RC-CT601	7371
1,4	48	09.86 - 05.91	K1J	4		RC-CT601	7371
1,4	55	08.92 - 04.97	TU3FM	4	SAE fitment: With Coil lead	RC-CT601	7371
1,4	55	08.92 - 05.95	TU3F	4	SAE fitment: With Coil lead	RC-CT601	7371
1,4	55	08.92 - 04.97	TU3FM	4	M4 fitment	RC-CT615	7285
1,4	55	08.92 - 05.95	TU3F	4	M4 fitment	RC-CT615	7285
1,4	62	09.86 - 07.92	K2B	4		RC-CT601	7371
1,4	62	09.86 - 07.92	K2A	4		RC-CT601	7371
1,4	69	06.91 - 07.92	KFZ	4		RC-CT601	7371
1,4	70	08.92 - 04.97	TU3FJ2	4		RC-CT601	7371

Berlingo

1,1	44	07.96 - 05.00	TU1M	4		RC-CT615	7285
1,1	44	06.00 - 10.02	TU1JP	4		RC-CT615	7285
1,4	55	07.96 - 10.05	TU3JP	4		RC-CT615	7285
1,8	66	04.97 - 10.02	XU7JB	4		RC-CR601	8471

BX

1,4	44	01.87 - 01.92	K1F	4		RC-CT601	7371
1,4	44	01.87 - 01.92	K1F	4		RC-CT613	7276
1,4	45	09.81 - 01.92	150A	4		RC-CT601	7371
1,4	45	09.81 - 01.92	150A	4	DIN fitment	RC-CT613	7276
1,4	45	01.85 - 12.86	150A	4	SAE fitment: With Coil lead	RC-CT601	7371
1,4	52	08.82 - 01.92	150C	4		RC-CT601	7371
1,4	52	08.82 - 01.92	150C	4	DIN fitment	RC-CT613	7276



kW

C
y
l

Stock-No.

CITROEN**BX**

1,4	52	01.85 - 12.86	150C	4	SAE fitment: With Coil lead	RC-CT601	7371
1,4	52	01.87 - 01.92	K1F	4		RC-CT601	7371
1,4	52	01.87 - 01.92	K1F	4		RC-CT613	7276
1,6	55	01.87 - 01.92	BAY	4		RC-CT611	7156
1,6	65	09.82 - 12.86	171B	4		RC-CT611	7156
1,6	65	09.82 - 12.86	171A	4		RC-CT611	7156
1,6	68	09.82 - 01.92	171C	4		RC-CT611	7156
1,6	76	03.86 - 06.94	180Z	4	DIN fitment: >12.88	RC-CT611	7156
1,6	76	03.86 - 12.94	180Z	4	SAE fitment	RC-CR604	8485
1,6	76	08.93 - 12.94	180Z	4	DIN fitment	RC-CT611	7156
1,9	75	10.83 - 12.86	159A	4	DIN fitment	RC-CT611	7156
1,9	75	01.87 - 01.92	DFZ	4		RC-CT605	7389
1,9	87	01.87 - 01.92	D6A	4		RC-CT602	7372
1,9	117	01.87 - 01.92	D6C	4		RC-PG602	8467

C15

1,1	35	10.84 - 12.96	109K/E1A	4		RC-PG618	7294
1,1	44	11.92 - 07.96	TU1MZ	4		RC-CT601	7371
1,4	48	11.86 - 10.89	K1J	4		RC-CT601	7371

C25

1,8	50	11.81 - 01.94	XM7T	4		RC-PG608	7109
2,0	60	11.81 - 01.94	XN1T	4		RC-PG608	7109

CX

2,0	74	06.86 - 07.89	829A5	4		RC-CT406	0566
2,0	74	06.86 - 07.89	829A5	4		RC-CT405	0586
2,0	78	07.79 - 05.86	829A5	4		RC-CT405	0586
2,0	78	08.82 - 05.86	829A5	4		RC-CT406	0566
2,2	85	06.81 - 07.89	J6TA500	4		RC-CT406	0566
2,4	96	06.77 - 06.82	M23-622	4		RC-CT1305	44221
2,5	89	08.89 - 12.92	M25668	4		RC-CT612	7192
2,5	100	08.83 - 07.89	M25659	4		RC-CT612	7192
2,5	115	10.84 - 07.89	M25667	4		RC-CT612	7192
2,5	122	08.83 - 07.89	M25662	4		RC-CT612	7192

Dispatch

1,6	59	10.95 - 08.00	220A2000	4		RC-FT203	0645
-----	----	---------------	----------	---	--	----------	------

Dyane

0,4	18	03.68 - 07.75	A791	2		RC-CT402	0583
0,7	21	08.80 - 10.84	M28	2		RC-CT402	0583
0,7	24	05.72 - 12.80	M28/1	2		RC-CT402	0583

Evasion

1,8	76	02.96 - 08.00	XU7JP	4		RC-CR601	8471
2,0	90	06.94 - 08.00	XU10J2	4		RC-CR602	8480
2,0	108	06.94 - 08.00	XU10J2TE	4		RC-CR602	8480

GS

1,0	41	04.70 - 07.77	G10612	4		RC-CT1304	6073
1,1	42	08.77 - 06.80	G11631	4		RC-CT1304	6073
1,2	43	04.70 - 06.79	G12611	4		RC-CT1304	6073
1,3	48	07.78 - 06.80	G13625	4		RC-CT1304	6073

GSA

1,3	48	09.79 - 02.87	G13646	4		RC-CT1304	6073
-----	----	---------------	--------	---	--	-----------	------

Jumpy

1,6	59	10.95 - 08.00	220A2000	4		RC-FT203	0645
-----	----	---------------	----------	---	--	----------	------



kW

C
y
l

Stock-No.

CITROEN**Jumper**

2.0	81	04.02 -	XU10J2	4		RC-PG617	7275
-----	----	---------	--------	---	--	----------	------

LN

0.6	23	11.76 - 07.79	R06627	2		RC-CT1301	6025
-----	----	---------------	--------	---	--	-----------	------

Mehari

0.6	21	09.68 - 12.87	A06635	2		RC-CT402	0583
-----	----	---------------	--------	---	--	----------	------

Saxo

1.0	33	02.96 - 11.98	TU9M	4		RC-CT615	7285
1.0	37	02.96 - 04.04	TU9M	4		RC-CT615	7285
1,1	40	05.96 - 06.00	TU1M	4		RC-CT615	7285
1,1	44	02.96 - 06.00	TU1M	4		RC-CT615	7285
1,1	44	07.00 - 04.04	TU1JP	4		RC-CT615	7285
1,4	55	02.96 - 06.03	TU3JP	4		RC-CT615	7285
1,6	66	02.96 - 06.03	TU5JP	4		RC-CT615	7285
1,6	74	02.01 - 04.04	TU5JP	4		RC-CT615	7285
1,6	80	02.96 - 07.99	TU5JP4	4		RC-CT615	7285
1,6	88	02.96 - 04.04	TU5JP4	4		RC-CT615	7285

Synergie

2.0	90	10.95 - 08.00	XU10J2	4		RC-CR602	8480
-----	----	---------------	--------	---	--	----------	------

Visa

0,7	26	09.78 - 05.86	V06630	2		RC-CT402	0583
0,7	26	08.82 - 12.87	V06644	2		RC-CT402	0583
1,1	37	03.81 - 12.87	1095F	4		RC-CT603	7377
1,2	46	09.80 - 07.82	1295	4		RC-CT603	7377
1,6	76	01.85 - 06.86	180A (XU5J)	4		RC-CT1306	44245

Xantia

1,6	66	03.93 - 07.01	XU5JP	4		RC-CR601	8471
1,8	66	11.96 - 12.00	XU7JB	4		RC-CR601	8471
1,8	76	03.93 - 10.96	XU7JP	4		RC-CR601	8471
2,0	89	03.93 - 08.99	XU10J2C	4		RC-CR602	8480
2,0	98	06.95 - 12.97	XU10J4R	4		RC-CR602	8480
2,0	108	06.95 - 08.99	XU10J2TE	4		RC-CR602	8480
2,0	112	03.93 - 01.98	XU10J4	4		RC-CR602	8480

XM

2.0	84	05.89 - 04.94		4		RC-PG1301	2578
2.0	90	05.89 - 12.93	XU10J2	4		RC-CR602	8480
2.0	98	08.94 - 07.96	XU10J4R	4		RC-CR602	8480
2.0	104	01.91 - 07.94	XU10J2TE	4		RC-CR602	8480
2.0	108	08.94 - 07.99	XU10J2TE	4		RC-CR602	8480
3.0	123	08.94 - 12.98	ZPJUFZ	6		RC-CT412	0592
3.0	147	10.89 - 04.97	ZPJ4UKZ	6		RC-PG609	7111

Xsara

1,4	55	07.97 - 03.05	TU3JP	4		RC-CT615	7285
1,6	65	09.99 - 09.01	TU5JP	4		RC-CT615	7285
1,6	66	07.97 - 08.00	TU5JP	4		RC-CT615	7285
1,6	66	11.97 - 08.00	TU5JP	4	>VET No. 07874	RC-CT615	7285
1,6	67	06.02 - 12.06		4		RC-CT615	7285
1,8	66	07.97 - 08.00	XU7JB	4		RC-CR601	8471
1,8	76	07.97 - 08.00	XU7JP	4		RC-CR601	8471
1,8	82	07.97 - 08.00	XU7JP4	4		RC-CR601	8471

ZX

1,1	44	03.91 - 10.97	TU1M	4		RC-CT601	7371
1,1	44	03.91 - 10.97	TU1M	4	M4 fitment	RC-CT615	7285
1,1	44	07.94 - 10.97	TU1M	4	SAE fitment: With Coil lead	RC-CT601	7371
1,4	55	03.91 - 06.94	TU3M	4		RC-CT601	7371
1,4	55	03.91 - 08.95	TU32	4		RC-CT601	7371



kW

C
y
l

Stock-No.

CITROEN**ZX**

1,4	55	06.93 - 06.94	TU3M	4	M4 fitment	RC-CT615	7285
1,4	55	03.91 - 08.95	TU32	4	M4 fitment	RC-CT615	7285
1,4	55	10.93 - 06.94	TU32	4		RC-CT615	7285
1,4	55	07.94 - 12.96	TU3MC	4		RC-CT601	7371
1,4	55	07.94 - 04.99	TU3MC	4	M4 fitment	RC-CT615	7285
1,6	65	03.91 - 06.94	XU5M	4		RC-CR601	8471
1,6	66	07.94 - 10.97	XU5JP	4		RC-CR601	8471
1,8	76	03.91 - 10.97	XU7JP	4		RC-CR601	8471
1,8	82	04.96 - 10.97	XU7JP4	4		RC-CR601	8471
1,9	89	03.91 - 06.94	XU9JAZ	4		RC-CR601	8471
1,9	96	03.91 - 09.93	XU9JAZ	4		RC-CR601	8471
2,0	89	06.92 - 06.94	XU10J2C	4		RC-CR602	8480
2,0	112	07.92 - 06.97	XU10J4	4		RC-CR602	8480

DACIA**1310**

1,3	40	06.83 - 08.90	810	4		RC-RN640	7379
1,3	40	09.90 - 12.94	817	4		RC-RN640	7379

Lodgy

1,6	61	03.12 -	K7MA8	4		RC-RN1202	4053
-----	----	---------	-------	---	--	-----------	------

Logan

1,4	55	08.04 -	K7J710	4		RC-RN1202	4053
-----	----	---------	--------	---	--	-----------	------

Logan II

1,6	62	05.10 -	K7M	4		RC-RN1202	4053
1,6	64	03.08 -	K7M	4		RC-RN1202	4053

Sandero

1,2	55	11.08 -	D4F	4		RC-RN1311	44278
1,4	55	06.08 -	K7J710	4		RC-RN1202	4053
1,6	64	06.08 -	K7M710	4		RC-RN1202	4053

DAEWOO**Espero**

1,5	55	10.97 - 09.99		4		RC-DW1201	2996
1,5	66	01.95 - 11.97	V15L	4		RC-DW403	0595
1,8	66	01.95 - 11.97	C18LE	4		RC-DW402	0594
1,8	70	01.95 - 11.97	Y18L	4		RC-DW402	0594
2,0	77	01.95 - 11.97	C20LE	4		RC-DW1201	2996

Evanda

2,0	96	08.02 - 12.04	X20SED	4		RC-DW301	8275
-----	----	---------------	--------	---	--	----------	------

Kalos

1,2	53	08.02 - 12.04	F12S3	4	>04.03	RC-DW301	8275
1,2	53	08.02 - 12.04	F12S3	4	04.03>	RC-DW1202	6020
1,4	61	08.02 - 12.04	F14S3	4		RC-DW301	8275
1,4	69	05.03 - 12.04	F14D3	4		RC-DW302	8276

Lacetti

1,4	69	08.03 - 12.04	F14D3	4		RC-DW1203	6022
1,6	80	08.03 - 12.04	F16D3	4		RC-DW1203	6022
1,8	90	08.03 - 12.04	T18SED	4		RC-DW1203	6022

Lanos

1,3	55	04.97 - 06.99	C14L	4		RC-DW301	8275
1,4	55	07.99 -	A13SM	4		RC-DW301	8275
1,5	63	04.97 - 06.99	Y15L	4		RC-DW301	8275
1,5	63	07.99 -	A15SM	4		RC-DW301	8275
1,5	73	07.99 - 10.01	A15SM	4		RC-DW301	8275



kW

C
y
l

Stock-No.

DAEWOO**Lanos**

1,6	78	04.97 - 06.99	616L	4		RC-DW302	8276
1,6	78	07.99 -	A16DM	4		RC-DW302	8276

Leganza

2,0	98	06.97 - 04.04	X20SED	4		RC-OP440	0810
2,0	133	01.01 - 12.02	X20SED	4		RC-OP440	0810

Matiz

0,8	38	04.98 - 08.04	F8CV	3	With distributor > Chassis No 577030	RC-DW304	7367
0,8	38	04.98 - 08.04	F8CV	3	Without distributor VIN No 577030 >	RC-DW1207	44331
1,0	47	11.02 - 12.04	G10CV	4		RC-DW1202	6020

Nexia

1,5	44	08.96 - 08.97	Y15L	4		RC-DW401	0593
1,5	52	01.95 - 08.97	Y15L	4		RC-DW401	0593
1,5	52	01.95 - 08.97	Y15L	4		RC-DW1201	2996
1,5	55	01.95 - 08.97	Y15L	4		RC-DW1201	2996
1,5	59	07.08 -	Y15L	4		RC-DW301	8275
1,5	66	01.95 - 08.97	V15L	4		RC-DW403	0595
1,6	80	07.08 -	F16D3	4		RC-DW403	0595

Nubira

1,4	69	10.03 - 12.04	F14D3	4		RC-DW302	8276
1,6	66	04.97 - 05.99	616L	4		RC-DW302	8276
1,6	76	08.02 - 03.04	A16DMS	4		RC-DW302	8276
1,6	78	04.97 - 05.99	616L	4		RC-DW302	8276
1,6	78	06.99 - 07.02	A16DM	4		RC-DW302	8276
1,6	80	08.03 - 12.04	F16D3	4		RC-DW1203	6022
1,8	90	07.03 - 12.04	X20SED	4		RC-OP440	0810
2,0	93	12.00 - 12.04	T20SED	4		RC-OP440	0810
2,0	98	06.99 - 07.02	X20SED	4		RC-OP440	0810

Rezzo

1,6	66	08.01 - 12.04	A16DMS	4		RC-DW302	8276
1,6	77	05.00 - 02.05	A16DMS	4		RC-DW302	8276
1,8	72	05.00 - 12.04	A18DMS	4		RC-DW1204	6258
1,8	67	05.00 - 12.04	F18D2	4		RC-DW1204	6258
2,0	89	05.00 - 12.04	X20SED	4		RC-OP440	0810

Tacuma

1,6	78	08.01 - 12.04	A16DMS	4		RC-DW302	8276
1,8	67	05.00 - 12.04	F18D2	4		RC-DW1204	6258
1,8	72	05.00 - 12.04	F18S2	4		RC-DW1204	6258
2,0	89	05.00 - 12.04	X20SED	4		RC-OP440	0810

DAIHATSU**Applause**

1,6	66	05.89 - 06.92	HDC	4		RC-ED1201	0348
1,6	73	09.97 - 05.00	HDE	4		RC-ED1201	0348
1,6	77	05.89 - 10.95	HDE	4		RC-ED1201	0348

Charade

1,0	37	09.78 - 01.83	CB20	3		RC-DE11	8921
1,0	38	02.83 - 03.96	CB22	3		RC-DE11	8921
1,0	38	02.87 - 10.90	CB23	3		RC-DE11	8921
1,0	40	11.90 - 02.93	CB90	3		RC-ED1203	5904
1,0	50	12.83 - 01.87	CB60	3		RC-DE11	8921
1,0	74	11.90 - 02.93	CB70	3		RC-DE11	8921
1,3	44	07.97 - 08.98	HCU	4		RC-DE23	8452
1,3	55	04.96 - 11.99	HCU	4		RC-DE23	8452
1,3	62	03.93 - 04.01	HCE	4		RC-ED1201	0348



kW

C
y
l

Stock-No.

DAIHATSU**Charade**

1,3	66	08.88 - 02.93	HCE	4		RC-ED1201	0348
1,3	67	07.93 - 03.96	HCE	4		RC-ED1201	0348
1,5	55	06.94 - 03.96	HEE	4		RC-ED1201	0348
1,5	66	06.94 - 03.96	HEE	4		RC-ED1201	0348

Charmant

1,3	48	08.81 - 08.83	4K	4		RC-TE83	8291
1,4	46	03.78 - 08.79	TJ	4		RC-TE86	9641
1,6	55	08.79 - 08.83	2T	4		RC-TE86	9641
1,6	57	09.83 - 12.87	4A	4		RC-TE83	8291
1,6	61	09.83 - 12.87	4A	4		RC-TE83	8291

Cuore

0,8	29	08.85 - 07.90	ED10	3		RC-DE16	8091
0,8	32	08.85 - 07.94	ED10	3		RC-DE16	8091
0,8	32	08.94 - 10.95	ED20	3		RC-DE16	8091
1,0	40	10.98 - 09.00	EJDE	3		RC-DE16	8091

Domino

0,8	32	08.85 - 07.90	ED	3		RC-DE11	8921
0,8	32	12.94 - 10.98	ED20	3		RC-DE11	8921

Feroza

1,6	62	10.88 - 12.97	HDC	4		RC-ED1202	0350
1,6	70	10.88 - 12.97	HDE	4		RC-ED1202	0350

Gran Move

1,5	66	10.96 - 07.98	HEEG	4		RC-DE23	8452
1,6	70	07.98 - 07.02	HDEP	4		RC-DE23	8452

Hijet

1,0	33	12.92 - 05.98	CP41	3		RC-ED1205	6871
-----	----	---------------	------	---	--	-----------	------

Mira

0,8	32	03.93 - 10.98	ED20	3		RC-DE11	8921
-----	----	---------------	------	---	--	---------	------

Move

0,8	32	01.97 - 11.99	ED20	3		RC-DE16	8091
1,0	40	01.99 - 12.00	EJDE	3		RC-DE16	8091

Rocky

1,6	70	01.90 - 12.92	HDE	4		RC-ED1202	0350
-----	----	---------------	-----	---	--	-----------	------

Sirion

1,0	40	04.98 - 10.00	EJDE	3		RC-DE16	8091
-----	----	---------------	------	---	--	---------	------

Sportrak

1,6	62	10.88 - 12.95	HDC	4		RC-ED1202	0350
1,6	70	10.88 - 12.95	HDE	4		RC-ED1202	0350

Storia

1,0	40	04.98 - 10.00	EJDE	3		RC-DE11	8921
-----	----	---------------	------	---	--	---------	------

Taft

1,6	48	09.76 - 07.85	12R	4		RC-EH1201	9057
-----	----	---------------	-----	---	--	-----------	------

Terios

1,3	61	05.97 - 09.00	HCEJ	4		RC-ED1204	6373
-----	----	---------------	------	---	--	-----------	------

Valera

1,5	66	06.94 - 03.96	HEE	4		RC-ED1201	0348
-----	----	---------------	-----	---	--	-----------	------



kW

C
y
l

Stock-No.

DODGE (CHRYSLER)**Caravan**

3,0	100	10.87 - 09.90	EFA	6		RC-CR304	8286
3,0	112	01.95 - 03.01	EFA	6		RC-CR304	8286

Grand Caravan

3,0 LE	100	10.87 - 09.90	EFA	6		RC-CR304	8286
--------	-----	---------------	-----	---	--	----------	------

Mini Ram

3,0 LWB	100	10.87 - 09.88	EFA	6		RC-CR304	8286
3,0	100	10.88 - 09.93	EFA	6		RC-CR304	8286

Ram Van

3,0	100	10.93 - 09.95	EFA	6		RC-CR304	8286
-----	-----	---------------	-----	---	--	----------	------

Shadow

3,0	100	10.92 - 09.94	EFA	6		RC-CR304	8286
-----	-----	---------------	-----	---	--	----------	------

Spirit

3,0	180	01.90 - 12.95	-	6		RC-CR304	8286
-----	-----	---------------	---	---	--	----------	------

EAGLE**Premier**

2,5	150	01.88 -	-	4		RC-GM1202	5557
-----	-----	---------	---	---	--	-----------	------

FIAT**126**

0,6	17	09.72 - 12.76	126 0.6 600	2		RC-FT1204	6969
0,6	17	07.77 - 09.87	126A1000	2		RC-FT442	0689
0,7	19	04.87 - 12.97	126A2048	2		RC-FT428	0675
0,7	20	01.77 - 10.86	126A1048	2		RC-FT442	0689

127

0,9	29	04.71 - 12.75	100GL048	4		RC-LC617	7286
0,9	33	06.73 - 12.84	100GL000	4		RC-LC617	7286
0,9	34	04.71 - 12.75	100GL048	4		RC-LC617	7286
1,0	37	01.76 - 06.81	127A000	4		RC-FT446	0693
1,0	51	03.77 - 06.81	127A1000	4		RC-FT446	0693
1,3	55	07.81 - 12.85	127A3000	4		RC-FT446	0693

128

1,1	33	05.69 - 11.74	128A048	4		RC-LC617	7286
1,1	40	05.69 - 06.81	128A000	4		RC-LC617	7286
1,1	47	09.74 - 02.81	128AC5000	4		RC-LC617	7286
1,3	44	07.72 - 06.81	128A1000	4		RC-LC617	7286

131

1,3	40	10.74 - 07.80	131A6000	4		RC-FT431	0678
1,3	48	06.74 - 10.77	131A000	6		RC-FT431	0678
1,3	48	10.74 - 07.80	131A000	4		RC-FT431	0678
1,3	57	11.77 - 07.80	131B000	4		RC-FT431	0678
1,4	52	08.80 - 08.85	131C000	4		RC-FT431	0678
1,4	53	08.80 - 08.85	131C000	4		RC-FT431	0678
1,6	55	04.74 - 07.80	131A1000	4		RC-FT431	0678
1,6	63	06.74 - 10.77	131A1000	4		RC-FT431	0678
1,6	63	08.80 - 08.85	131C2000	4		RC-FT431	0678
1,6	72	11.77 - 07.80	131B1000	4		RC-FT431	0678
2,0	83	03.78 - 07.80	131B2000	4		RC-FT431	0678
2,0	84	08.80 - 08.85	131B2000	4		RC-FT431	0678
2,0	103	11.77 - 07.80	131B2000	4		RC-FT431	0678



kW

C
y
l

Stock-No.

FIAT							
132							
1,6	66	11.77 - 05.82	132C6000	4		RC-FT431	0678
1,6	72	10.72 - 05.82	132C000	4		RC-FT431	0678
2,0	82	11.77 - 05.82	132C2000	4		RC-FT431	0678
2,0	88	08.79 - 05.82	132C3000	4		RC-FT431	0678
242							
1,6	45	05.74 - 08.79	124B3	4		RC-FT431	0678
2,0	52	05.74 - 08.79	132AZ2	4		RC-FT431	0678
2,0 E	52	09.79 - 06.85	132AZ2000	4		RC-FT431	0678
500 Nuova							
0,5	15	06.68 - 04.72	1015N	2		RC-FT1205	6980
500							
1,2	51	10.07 -	169.A4.000	4		RC-FT1209	4746
1,4	74	10.07 -	169.A4.000	4		RC-FT1209	4746
850							
0,9 T	29	02.74 - 06.77	100GL048	4		RC-LC617	7286
900							
0,9 E	33	10.79 - 08.85	100GL000	4		RC-LC617	7286
Albea							
1,2	44	11.00 -	188A4000	4		RC-FT601	8192
Argenta							
1,6	72	02.81 - 02.87	132D000	4		RC-FT431	0678
2,0	90	02.81 - 02.87	132C3000	4		RC-FT431	0678
Brava							
1,2	59	09.00 - 05.02	188A5000	4		RC-FT201	0643
1,2	60	09.98 - 08.00	182B2000	4		RC-FT1203	2995
1,4	55	10.95 - 02.97	182A5000	4		RC-FT201	0643
1,4	59	10.95 - 08.98	182A3000	4		RC-FT201	0643
1,6	66	10.95 - 02.97	182A6000	4		RC-FT1202	2571
1,6	76	10.95 - 08.00	182A4000	4		RC-FT1202	2571
Bravo							
1,2	59	09.00 - 02.02	188A5000	4		RC-FT1203	2995
1,2	60	09.98 - 08.00	182B2000	4		RC-FT1203	2995
1,4	55	10.95 - 02.97	182A5000	4		RC-FT201	0643
1,4	59	10.95 - 08.98	182A3000	4		RC-FT201	0643
1,6	66	10.95 - 02.97	182A6000	4		RC-FT1202	2571
1,6	76	10.95 - 08.00	182A4000	4		RC-FT1202	2571
1,6	76	09.00 - 02.02	182B6000	4		RC-FT1202	2571
Cinquecento							
0,7	22	04.92 - 02.98	170A046	2		RC-FT620	8503
0,7	23	04.92 - 09.94	170A000	2		RC-FT620	8503
0,9	29	03.92 - 07.99	1170A1046	4		RC-FT604	8205
0,9	29	04.92 - 12.93	170A1000	4		RC-FT604	8205
0,9	30	04.92 - 09.94	170A1046	4		RC-FT604	8205
0,9	30	10.94 - 02.98	1170A1000	4		RC-FT604	8205
1,1	40	10.94 - 07.99	176B2000	4		RC-FT601	8192
Coupe							
2,0	102	02.94 - 08.96	836A3000	4		RC-FT603	8202
2,0 Turbo iE	143	02.94 - 08.96	175A1000	4		RC-FT618	8248
Croma							
1,6	62	08.86 - 10.88	154A048	4		RC-FT631	7203
2,0	66	08.86 - 02.91	154A1000	4		RC-FT631	7203
2,0	74	03.91 - 12.92	154C2048	4		RC-FT631	7203



kW

C
y
l

Stock-No.

FIAT

Croma

2.0	85	08.86 - 04.93	154C3046	4		RC-FT631	7203
2.0	85	03.91 - 12.96	834B146	4		RC-FT631	7203
2.0	103	03.91 - 12.96	154E1000	4		RC-LC1101	44231
2.0 Turbo iE	110	04.87 - 12.96	154C4046	4		RC-FT631	7203
2.5	118	03.93 - 12.96	834G000	6		RC-LC901	8575

Doblo

1,2	47	11.00 - 10.05	223A5000	4		RC-FT1208	9262
1,2	48	02.04 - 10.05	223A5000	4		RC-FT1208	9262
1,4	57	10.05 -	350A1000	4		RC-FT1209	4746
1,6	76	10.01 -	182 B6.000	4		RC-FT1202	2571

Ducato

1,8	49	08.81 - 05.86	XM7T	4		RC-PG608	7109
1,8	51	06.86 - 05.90	XN7T	4		RC-PG608	7109
1,8	60	08.81 - 05.86	XM7T	4		RC-PG608	7109
2,0	55	06.86 - 05.90	XN1T	4		RC-PG608	7109
2,0	55	06.90 - 02.94	170D	4		RC-PG608	7109
2,0	55	11.90 - 02.93	170B	4		RC-PG608	7109
2,0	58	08.81 - 05.86	XN1T	4		RC-PG608	7109
2,0	63	06.86 - 05.90	XN1T2	4		RC-PG608	7109
2,0	63	06.90 - 02.94	170DI	4		RC-PG608	7109
2,0	80	03.94 - 11.01	RFW	4		RC-CR601	8471
2,0	80	04.02 -	RFL	4		RC-PG617	7275

Duna

1,1 Elba	43	04.86 - 03.91	146A6000	4		RC-FT615	8218
1,1	43	06.87 - 12.91	146A6000	4		RC-FT615	8218
1,3 Elba	49	04.86 - 03.91	146A5000	4		RC-FT615	8218
1,3	52	06.87 - 12.91	146A5000	4		RC-FT615	8218

Elba CSL

1,3	49	04.91 - 10.93	146A5000	4		RC-FT638	7291
-----	----	---------------	----------	---	--	----------	------

Fiorino

0,9	33	04.77 - 12.84	100GL000	4		RC-FT446	0693
1,0	33	11.92 - 04.96	156A2246	4		RC-FT621	8523
1,1	40	01.88 - 10.92	146A9000	4		RC-FT446	0693
1,3	49	01.88 - 12.94	146A5000	4		RC-FT638	7291
1,5	55	05.88 - 05.93	149C1000	4		RC-FT608	8210

Fiorino 3

1,4	57	10.09 -	350A1000	4		RC-FT1209	4746
-----	----	---------	----------	---	--	-----------	------

Idea

1,4	66	12.03 -	192B2000	4		RC-FT1209	4746
1,4	70	01.04 -	843A1000	4		RC-FT1209	4746
1,4	57	10.05 -	350 A1000	4		RC-FT1209	4746

Linea

1,4	57	06.07 -	350 A1000	4		RC-FT1209	4746
1,4	88	09.07 -	198A4000	4		RC-FT1209	4746

Marea

1,2	60	03.99 - 08.00	182B2000	4		RC-FT1203	2995
1,4	59	08.96 - 02.99	182A3000	4		RC-FT201	0643
1,6	68	03.99 - 08.00	185A3000	4		RC-FT1202	2571
1,6	75	04.97 - 02.99	185A3000	4		RC-FT1202	2571
1,6	76	08.96 - 08.00	182A4000	4		RC-FT1202	2571
1,6	76	09.00 - 08.02	182B6000	4		RC-FT1202	2571



kW

C
y
l

Stock-No.

FIAT							
Multipla							
1,6	74	02.99 -	186A4000	4		RC-FT1202	2571
1,6	76	08.98 - 08.00	182A4000	4		RC-FT1202	2571
1,6	76	09.00 - 10.06	182B6000	4		RC-FT1202	2571
Palio							
1,2	44	09.00 -	188A4000	4		RC-FT601	8192
1,2	54	07.97 - 08.01	178B5000	4		RC-FT601	8192
1,2	59	09.01 -	188A5000	4		RC-FT1203	2995
1,4	51	07.97 - 08.99	178B2000	4		RC-FT1207	5607
1,6	74	07.97 - 08.02	178B3000	4		RC-FT1202	2571
1,6	76	09.00 -	182B6000	4		RC-FT1202	2571
Panda							
0,7	18	10.80 - 04.86	141A000	2		RC-FT414	0660
0,7	22	10.80 - 04.86	141A000	2		RC-FT414	0660
0,8	25	05.86 - 04.91	141B0000	4		RC-FT435	0682
0,8	25	05.86 - 04.91	141B0000	4		RC-FT621	8523
0,8	25	05.86 - 12.93	156A4000	4		RC-FT621	8523
0,8	25	10.88 - 04.91	156A4048	4		RC-FT621	8523
0,8	25	05.91 - 12.93	141B000	4		RC-FT435	0682
0,9	29	05.91 - 08.98	1170A1046	4		RC-FT607	8208
0,9	33	10.80 - 04.86	141A300	4		RC-FT435	0682
1,0	31	09.87 - 04.91	156A2100	4		RC-FT621	8523
1,0	32	11.87 - 04.91	156A2100	4		RC-FT621	8523
1,0	33	05.86 - 07.97	156A2246	4		RC-FT621	8523
1,0	33	05.86 - 04.91	156A2000	4		RC-FT621	8523
1,0	33	05.91 - 10.95	156A2000	4	01.92>	RC-FT601	8192
1,0	33	03.95 - 08.98	141C2000	4		RC-FT621	8523
1,0	37	05.86 - 05.94	156A3000	4		RC-FT621	8523
1,1	37	05.91 - 12.92	156C046	4		RC-FT454	0701
1,1	37	01.93 - 03.95	156C046	4		RC-FT601	8192
1,1	40	04.95 - 12.99	176B2000	4		RC-FT601	8192
1,1	40	09.03 -	187A1000	4		RC-FT1208	9262
1,2	44	09.03 -	188A4000	4		RC-FT1208	9262
1,2	51	11.09 -	169A4000	4		RC-FT1209	4746
1,4	57	10.09 -	350A1000	4		RC-FT1209	4746
Penny							
1,3	52	04.86 - 08.89	146A5000	4		RC-FT615	8218
Punto (Typ176)							
1,1	40	08.93 - 11.96	176A6000	4		RC-FT601	8192
1,1	40	10.93 - 08.00	176B2000	4		RC-FT601	8192
1,2	43	10.93 - 03.97	176A7000	4		RC-FT601	8192
1,2	44	12.96 - 07.99	176B4000	4		RC-FT601	8192
1,2	54	10.93 - 10.98	176A8000	4		RC-FT601	8192
1,2	63	12.96 - 07.99	176B9000	4	>MOT No 8297330	RC-FT601	8192
1,2	63	12.96 - 07.99	176B9000	4	MOT No 8297330>	RC-FT632	7209
1,4	96	12.96 - 07.99	176B6000	4		RC-FT202	0644
1,4	98	10.93 - 11.96	176A4000	4		RC-FT202	0644
1,6	66	04.94 - 10.97	176A9000	4	DIN fitment	RC-FT602	8193
1,6	66	04.94 - 10.97	176A9000	4	M4 fitment	RC-FT628	7171
Punto (Typ188)							
1,2	44	08.99 - 11.10	188A4000	4		RC-FT1208	9262
1,2 Van	44	08.99 - 05.03	188A4000	4		RC-FT601	8192
1,2	59	08.99 - 05.03	188A5000	4		RC-FT1203	2995
Punto Evo (Typ199)							
1,2	48	10.09 - 02.12	199A4000	4		RC-FT1209	4746
1,2	51	10.09 - 02.12	169A4000	4		RC-FT1209	4746
1,4	55	07.09 - 02.12	199A7000	4		RC-FT1209	4746



kW

C
y
I

Stock-No.

FIAT

Punto Evo (Typ199)

1,4	57	06.09 - 02.12	350A1000	4		RC-FT1209	4746
-----	----	---------------	----------	---	--	-----------	------

Punto Grande (Typ199)

1,2	48	10.05 -	199A4000	4		RC-FT1209	4746
1,2	51	09.10 -	169A4000	4		RC-FT1209	4746
1,4	55	06.06 -	199A7000	4		RC-FT1209	4746
1,4	57	10.05 -	350A1000	4		RC-FT1209	4746
1,4	70	10.05 -	199A6000	4		RC-FT1209	4746
1,4	88	09.07 -	198A4000	4		RC-FT1209	4746

Qubo

1,4	57	10.09 -	350A1000	4		RC-FT1209	4746
-----	----	---------	----------	---	--	-----------	------

Regata

1,3	48	06.83 - 08.86	149A3000	4		RC-LC609	8524
1,3	48	09.86 - 06.89	149A7000	4		RC-LC609	8524
1,3	50	06.83 - 08.86	138B2000	4		RC-LC609	8524
1,5	55	02.84 - 08.86	149A2000	4		RC-FT418	0665
1,5	55	03.85 - 08.86	138A2000	4		RC-FT418	0665
1,5	60	02.84 - 08.86	138B3000	4		RC-FT415	0661
1,6	60	09.86 - 06.89	149A000	4		RC-FT415	0661
1,6	74	06.83 - 10.89	149A4000	4		RC-FT420	0667

Ritmo

1,0	44	10.77 - 02.83	127A6000	4		RC-FT417	0664
1,1	40	05.85 - 08.88	138C1000	4		RC-FT621	8523
1,1	43	04.85 - 12.87	146A44048	4		RC-FT636	7205
1,3	48	10.77 - 02.83	138A1000	4		RC-FT417	0664
1,3	51	03.83 - 08.88	138B2000	4		RC-FT420	0667
1,3	51	05.85 - 08.88	149A7000	4		RC-FT420	0667
1,3	55	06.78 - 09.82	138A3000	4		RC-FT417	0664
1,5	55	05.82 - 08.88	138A2000	4		RC-FT636	7205
1,5	55	10.86 - 08.88	138C2048	4		RC-FT636	7205
1,5	63	10.79 - 09.83	138A4000	4		RC-FT420	0667
1,5	63	03.81 - 08.88	138B3000	4		RC-FT420	0667
1,5	63	05.85 - 08.88	138C2048	4		RC-FT636	7205
1,6	77	10.80 - 05.85	138AR000	4		RC-FT420	0667
2,0	96	05.85 - 08.88	138AR2000	4		RC-FT420	0667

Sedici

1,6	79	06.06 -	M16A	4		RC-SE45	1845
1,6	88	06.06 -	1170A1046	4		RC-SE45	1845

Seicento

0,9	29	03.98 - 02.00	1170A1046	4		RC-FT604	8205
1,1	40	03.98 - 12.00	176B2000	4		RC-FT601	8192
1,1	40	03.00 - 05.01	187A1000	4	SPI	RC-FT601	8192
1,1	40	06.01 - 05.09	187A1000	4	MPI	RC-FT1208	9262

Siena

1,2	44	09.01 -	188A4000	4		RC-FT601	8192
1,2	54	09.98 -	178B5000	4		RC-FT601	8192
1,2	59	09.01 -	188A5000	4		RC-FT1203	2995
1,4	51	04.96 -	178B2000	4		RC-FT1207	5607
1,4	57	01.07 -	199A1000	4		RC-FT1209	4746
1,6	76	11.00 -	182B6000	4		RC-FT1202	2571
1,6	78	09.98 -	178B3000	4		RC-FT1203	2995



kW

C
y
l

Stock-No.

FIAT**Strada Pick Up**

1,2	44	04.03 -	188A4000	4		RC-FT601	8192
1,2	54	06.99 -	178B5000	4		RC-FT601	8192
1,2	60	10.05 -	178B7045	4		RC-FT601	8192

Tempra

1,4	51	04.90 - 07.96	160A1046	4		RC-FT609	8211
1,4	51	04.90 - 06.93	159A2000	4		RC-FT634	7242
1,4	55	04.91 - 07.96	159A2000	4		RC-FT634	7242
1,4	62	04.91 - 06.93	160A1046	4		RC-FT609	8211
1,6	51	07.93 - 07.96	159A3048	4		RC-FT203	0645
1,6	57	04.90 - 06.93	159A3046	4		RC-FT609	8211
1,6	57	07.93 - 07.96	835C1000	4		RC-FT203	0645
1,6	57	07.93 - 07.96	835C1000	4	159A3046	RC-FT609	8211
1,6	62	04.90 - 06.93	159A3000	4		RC-FT609	8211
1,6	63	04.90 - 06.93	159A3000	4		RC-FT609	8211
1,6	66	07.93 - 07.96	159B9000	4		RC-FT203	0645
1,8	66	07.93 - 07.96	835C4000	4		RC-LC611	8529
1,8	77	04.90 - 07.96	159A4046	4		RC-LC611	8529
2,0	80	04.90 - 06.93	159A6046	4		RC-LC611	8529
2,0	85	04.90 - 07.96	159A6046	4		RC-LC611	8529

Tipo

1,1	41	03.88 - 10.92	160A3000	4		RC-FT621	8523
1,4	50	03.88 - 10.92	160A1048	4		RC-FT634	7242
1,4	51	05.89 - 09.95	160A1046	4		RC-LC604	8220
1,4	57	05.89 - 10.92	159A2000	4		RC-FT608	8210
1,4	52	03.88 - 10.92	160A1000	4		RC-FT634	7242
1,4	55	11.92 - 12.94	159A2000	4		RC-FT608	8210
1,6	56	03.88 - 09.95	159A3048	4		RC-FT609	8211
1,6	57	11.92 - 09.95	835C1000	4		RC-FT609	8211
1,6	58	03.88 - 10.92	160A2000	4		RC-FT609	8211
1,6	62	03.88 - 10.92	159A3046	4		RC-FT609	8211
1,6	66	05.89 - 10.92	159A3000	4		RC-FT609	8211
1,6	66	08.89 - 10.90	149C2046	4		RC-FT609	8211
1,8	66	11.92 - 09.95	835C4000	4		RC-FT601	8192
1,8	77	11.92 - 09.95	835C2000	4		RC-LC611	8529
1,8	80	06.88 - 10.92	159A4000	4		RC-LC611	8529
1,8	80	06.88 - 10.92	159A4046	4		RC-LC611	8529
1,8	100	04.90 - 10.92	160A5000	4		RC-FT603	8202
2,0	80	03.91 - 10.92	159A5046	4		RC-LC611	8529
2,0	85	03.88 - 10.92	159A6046	4		RC-LC611	8529
2,0	85	10.90 - 10.92	159A5046	4		RC-LC611	8529
2,0	102	11.92 - 09.95	836A3000	4		RC-FT603	8202
2,0	107	11.91 - 10.92	160A8046	4		RC-FT603	8202

Ulysse

2,0	89	04.94 - 08.00	RFU	4		RC-CR602	8480
2,0	108	04.94 - 08.00	RGX	4		RC-CR602	8480

Uno

0,9	30	02.84 - 12.88	100GL000	4		RC-LC617	7286
0,9	33	04.84 - 08.87	146A000	4		RC-ST404	0905
0,9	33	09.87 - 10.95	146A048	4		RC-FT435	0682
0,9	34	02.84 - 12.88	146A000	4		RC-ST404	0905
1,0	31	06.89 - 02.92	156A2100	4		RC-FT621	8523
1,0	33	04.84 - 08.87	156A2044	4		RC-FT621	8523
1,0	33	09.87 - 10.94	156A2000	4		RC-FT621	8523
1,0	33	09.89 - 04.98	156A2246	4		RC-FT621	8523
1,0	35	04.84 - 08.87	156A2045	4		RC-FT621	8523



kW

C
y
l

Stock-No.

FIAT**Uno**

1,0	41	04.94 - 08.00		4		RC-FT621	8523
1,1	36	09.89 - 09.95	146C3000	4		RC-FT621	8523
1,1	37	06.85 - 12.88	146A4046	4		RC-FT621	8523
1,1	37	10.90 - 07.93	156C046	4		RC-FT621	8523
1,1	40	01.83 - 08.89	138B000	4		RC-FT636	7205
1,1	41	01.89 - 09.95	160A3000	4		RC-FT621	8523
1,1	42	09.87 - 12.88	160A3000	4		RC-FT621	8523
1,1	43	05.85 - 08.89	146A4048	4		RC-FT636	7205
1,3	48	04.84 - 08.87	149A7000	4		RC-FT636	7205
1,3	51	02.84 - 08.87	138B2000	4		RC-LC609	8524
1,3 Turbo iE	73	06.87 - 12.88	146A2146	4		RC-FT635	7244
1,3 Turbo iE	77	01.89 - 12.91	146A2246	4		RC-FT635	7244
1,4	51	01.89 - 10.95	160A1046	4		RC-FT608	8210
1,4	52	01.89 - 10.92	160A1048	4		RC-OP1203	6995
1,4 Turbo iE	74	01.89 - 12.91	146A8000	4		RC-FT1206	5504
1,4 Turbo iE	82	01.92 - 12.94	146A8046	4		RC-FT635	7244
1,4 Turbo iE	87	01.89 - 07.93	146A8000	4		RC-FT1206	5504
1,5	55	10.84 - 02.87	138C2048	4		RC-FT608	8210
1,5	55	03.87 - 12.94	149C1000	4		RC-FT608	8210
1,5	56	07.86 - 12.88	149C1000	4		RC-FT608	8210

FORD**Capri**

1,6	44	11.70 - 12.73	TL16L	4		RC-FD825	8569
1,6	50	01.74 - 02.78	TL16LC	4		RC-FD825	8569
1,6	50	01.74 - 02.78	TL16L	4		RC-FD825	8569
1,6	53	01.74 - 02.78	TL16L	4		RC-FD825	8569
1,6	54	03.78 - 02.87	TL16	4		RC-FD825	8569
1,6	65	11.72 - 02.78	TL16H	4		RC-FD825	8569
2,0	64	03.78 - 08.86	TL20LNM	4		RC-FD825	8569
2,0	66	01.74 - 08.85	TV20H	6		RC-FD830	7406
2,0	72	01.74 - 02.78	TL20H	4		RC-FD825	8569
2,0	74	03.78 - 02.87	TL20H	4		RC-FD825	8569
2,3	80	03.78 - 02.87	TV23HYN	6		RC-FD830	7406
2,3	84	03.78 - 02.87	TV23HYN	6		RC-FD830	7406
2,8	118	04.81 - 02.87	TV28HI	6		RC-FD830	7406
2,8 Turbo	138	09.81 - 08.86	TV28ERJ	6		RC-FD830	7406
3,0	101	01.74 - 02.78	TV30HYT	6		RC-FD508	0603
3,0	101	03.78 - 06.81	TV30HYP	6		RC-FD830	7406

C-Max

1,6	74	02.07 -	HWDA / HWDB	4		RC-FD807	8541
1,6	74	02.07 -	SHDA / SHDB / SHDC	4		RC-FD807	8541

C-Max II

1,6	77	12.10 -	IQDA / IQDB	4		RC-FD807	8541
1,6	88	02.11 -	MUDA	4		RC-FD807	8541
1,6	92	12.10 -	PNDA	4		RC-FD807	8541

Consul

2,0	73	02.72 - 08.75	TL20NE	4		RC-FD825	8569
2,5	88	02.72 - 08.75	EV25HRB	6		RC-FD508	0603
3,0	102	02.72 - 08.77	EV30	6		RC-FD508	0603

Cortina

1,6	53	09.71 - 08.82	LCJ	4		RC-FD825	8569
1,6	55	08.76 - 08.79	LER	4		RC-FD825	8569



kW

C
y
l

Stock-No.

FORD**Cortina**

1,6	55	09.79 - 08.82	LCJ	4		RC-FD825	8569
1,6	63	09.70 - 05.72	LCJ	4		RC-FD825	8569
1,6	66	08.76 - 08.79	LER	4		RC-FD825	8569
2,0	64	09.75 - 08.76	NEG	4		RC-FD825	8569
2,0	72	09.76 - 08.79	NEG	4		RC-FD825	8569
2,0	74	09.79 - 08.82	NER	4		RC-FD825	8569
2,3	79	09.71 - 08.76	YYF	6		RC-FD830	7406

Cougar

2,0	96	08.98 - 08.01	ZH20EDBB	4		RC-FD808	8542
2,0	96	08.98 - 08.01	ZH20EDBD	4		RC-FD808	8542
2,0	96	08.98 - 08.01	ZH20EDBA	4		RC-FD808	8542
2,5	125	08.98 - 08.00	MP25LCBA	6		RC-FD1204	7701
2,5	125	08.98 - 08.00	JP25LCBD	6		RC-FD1204	7701
2,5	125	09.99 - 08.00	LCBB/LCBC/ LCBE	6		RC-FD1204	7701
2,5	125	09.00 - 08.01	MP25LCBA	6		RC-FD1211	1644
2,5	125	09.00 - 08.01	JP25LCBD	6		RC-FD1211	1644
2,5	125	09.00 - 12.01	LCBB/LCBC/ LCBE	6		RC-FD1211	1644
2,5	151	02.99 - 08.00	JP25SGA	6		RC-FD1204	7701
2,5	151	09.00 - 08.01	JP25SGA	6		RC-FD1211	1644

Courier (Fiesta)

1,3	44	04.91 - 08.95	BL13CFIJ6B	4		RC-FD538	0633
1,3	44	09.95 - 10.96	BL13EIFNJ4C	4		RC-FD544	0639
1,3	44	11.96 - 10.97	BL13EIFNJ4J	4		RC-FD544	0639
1,3	44	11.97 - 10.98	BL13EIFNJ4L	4		RC-FD544	0639
1,3	44	09.98 - 10.00	BL13EIFNJ4Q	4		RC-FD1205	2584
1,4	66	04.96 - 05.98	FHA	4		RC-FD548	0642
1,4	66	06.98 - 10.99	FHA	4		RC-FD1217	44250

Escort

1,1	37	09.80 - 02.86	BL11E	4		RC-FD804	8537
1,1	37	03.86 - 10.89	BL11EGSG	4		RC-FD804	8537
1,1	40	09.80 - 08.83	HL11L	4		RC-FD509	0604
1,1	40	09.80 - 08.82	BL11L	4		RC-FD509	0604
1,3	38	04.68 - 11.74	KL13	4		RC-FD804	8537
1,3	40	12.74 - 08.80	KL13	4		RC-FD804	8537
1,3	44	08.69 - 08.80	KL13H	4		RC-FD804	8537
1,3	44	09.80 - 02.86	KL13	4		RC-FD804	8537
1,3	44	03.86 - 08.90	BL13LJLA	4		RC-FD804	8537
1,3	44	03.86 - 08.88	KL13JLB	4		RC-FD804	8537
1,3	44	04.87 - 08.90	BL13LJLB	4		RC-FD804	8537
1,3	44	09.90 - 10.92	BL13JBE	4		RC-FD538	0633
1,3	44	09.90 - 08.97	BL13CFIJ6A	4		RC-FD538	0633
1,3	44	01.95 - 09.99	BL13CFIJ4B	4		RC-FD538	0633
1,3	46	12.90 - 08.93	BL13JBD	4		RC-FD538	0633
1,3	48	09.83 - 02.86	ZL13G	4		RC-FD509	0604
1,3	51	12.74 - 08.80	KL13G	4		RC-FD804	8537
1,3	51	09.80 - 02.86	HL13H	4		RC-FD509	0604
1,4	51	03.86 - 08.90	H14FUAA	4		RC-FD509	0604
1,4	52	09.90 - 12.94	HL14F6F	4		RC-FD537	0632
1,4	54	04.87 - 08.90	HL14CFIF6B	4		RC-FD509	0604
1,4	54	04.87 - 08.90	HL14CFIF6D	4		RC-FD509	0604
1,4	54	09.90 - 09.96	HL14CFIF4B	4		RC-FD537	0632
1,4	54	12.94 - 08.00	HL14EFIF4B	4		RC-FD537	0632
1,4	55	03.86 - 08.90	HL14HFUA	4		RC-FD509	0604
1,4	55	08.93 - 02.99	FAB/FUH	4		RC-FD537	0632
1,6	58	03.86 - 08.89	HL16LP2	4		RC-FD509	0604



kW

C
y
l

Stock-No.

FORD**Escort**

1,6	59	09.80 - 02.86	HL16L	4		RC-FD509	0604
1,6	65	03.86 - 08.90	HL16LUG	4		RC-FD509	0604
1,6	65	07.93 - 12.94	ZH16EL1H	4	DIN fitment	RC-FD546	0641
1,6	65	01.95 - 12.96	ZH16L1E	4		RC-FD546	0641
1,6	66	12.84 - 02.86	HL16EFI	4		RC-FD509	0604
1,6	66	03.86 - 08.90	HL16LUC	4		RC-FD509	0604
1,6	66	03.86 - 08.90	HL16L4B	4		RC-FD509	0604
1,6	66	09.90 - 10.92	HL16HLUK	4		RC-FD537	0632
1,6	66	09.90 - 12.92	HL16HLUJ	4		RC-FD537	0632
1,6	66	09.92 - 12.94	ZH16L1E	4		RC-FD546	0641
1,6	66	07.93 - 12.94	ZH16EE1	4		RC-FD546	0641
1,6	66	01.95 - 08.00	ZH16L2E	4	DIN fitment	RC-FD546	0641
1,6	66	01.95 - 08.00	ZH16L1K	4		RC-FD546	0641
1,6	75	03.86 - 08.90	HL16EFILJB	4		RC-FD826	8571
1,6	75	05.91 - 12.92	HL16EFILJF	4		RC-FD826	8571
1,6 RS	77	09.80 - 02.86	HL16MFI	4		RC-FD509	0604
1,6	77	03.86 - 08.90	HL16EFILRB	4		RC-FD509	0604
1,6	77	09.90 - 12.94	HL16EFILJF	4		RC-FD826	8571
1,6 XR3i	80	09.81 - 02.86	HL16EFI	4		RC-FD509	0604
1,6	80	09.83 - 02.86	HL16EFI	4		RC-FD509	0604
1,6 RS	85	10.83 - 02.86	HL16HUC	4		RC-FD509	0604
1,6 Turbo RS	97	03.86 - 08.90	HL16GLNB	4		RC-FD803	8536
1,8	77	09.91 - 10.96	ZH18NRDA	4	DIN fitment	RC-FD546	0641
1,8 XR3i	77	07.93 - 12.94	ZH18NRDA	4	DIN fitment	RC-FD546	0641
1,8	85	01.95 - 08.00	ZH18MRKC	4	DIN fitment	RC-FD546	0641
1,8 XR3i	96	09.91 - 12.94	ZH18PRQB	4	DIN fitment	RC-FD546	0641
1,8	96	09.92 - 12.94	ZH18PRQB	4	DIN fitment	RC-FD546	0641
1,8	96	01.95 - 08.00	ZH18PRQB	4		RC-FD546	0641
1,8 RS TC	115	12.74 - 08.80	FA5	4		RC-FD546	0641
2,0 RS 2000	110	08.90 - 12.97	DH20N7A	4	Semi-Direct	RC-FD1203	5405
2,0 RS Cosworth	162	10.91 - 12.94	CH20N5E	4		RC-FD901	8589
2,0 RS Cosworth	162	01.95 - 10.96	CH20N5F	4		RC-FD901	8589

Fiesta

1,0	29	05.75 - 08.83	KL09L	4		RC-FD804	8537
1,0	29	09.83 - 09.89	BL09LTKW	4		RC-FD804	8537
1,0	33	09.83 - 09.89	BL09HTKA	4		RC-FD804	8537
1,0	33	09.83 - 09.89	BL09HTKB	4		RC-FD804	8537
1,0	33	10.89 - 12.96	BL10LTLB	4		RC-FD538	0633
1,1	37	09.83 - 09.89	BL11GSI	4		RC-FD804	8537
1,1	37	09.83 - 09.89	BL11EGSF	4		RC-FD804	8537
1,1	37	10.89 - 12.96	BL11CFIG6A	4		RC-FD538	0633
1,1	39	04.78 - 08.83	BL11M	4		RC-FD804	8537
1,1	40	10.89 - 12.92	BL11GUE	4		RC-FD538	0633
1,1	40	10.89 - 12.92	BL11GUD	4		RC-FD538	0633
1,2	51	03.03 -	ZH12M7JB	4		RC-FD807	8541
1,2	55	09.95 - 10.96	ZH12DHA	4	01.98>	RC-FD807	8541
1,2	55	09.95 - 10.96	ZH12DHA	4	>12.97	RC-FD548	0642
1,2	55	11.96 - 10.97	ZH12DHB	4		RC-FD548	0642
1,2 RS	55	03.97 - 10.97	ZH12DHB	4		RC-FD548	0642
1,2	55	11.97 - 10.98	ZH12DHC	4		RC-FD548	0642
1,2	55	11.98 - 08.99	ZH12DHD	4		RC-FD548	0642
1,2	55	09.95 - 05.98	ZH12DHE/HF/HG	4		RC-FD548	0642
1,2	55	06.98 - 12.99	ZH12DHE/HF/HG	4		RC-FD1217	44250
1,2	55	01.00 - 04.02	ZH12DHE/HF/HG	4		RC-FD807	8541
1,2	55	03.03 -	ZH12FUJB	4		RC-FD807	8541
1,25	60	10.08 -	SNJA / SNJB	4		RC-FD807	8541



kW

C
y
l

Stock-No.

FORD**Fiesta**

1,3	37	01.96 - 10.96	BL13EFILJJA	4		RC-FD544	0639
1,3	37	11.96 - 10.97	BL13EFILJJC	4		RC-FD544	0639
1,3	37	11.97 - 10.98	BL13EFILJJE	4		RC-FD544	0639
1,3	37	11.98 - 08.99	BL13EFILJJJ	4		RC-FD1205	2584
1,3	37	09.99 - 10.00	BL13EFILJJK	4		RC-FD1205	2584
1,3	37	11.00 - 04.02	BL13EFILJJM	4		RC-FD1205	2584
1,3	43	05.02 -	B13A8JA	4		RC-FD1210	6317
1,3	44	09.83 - 09.89	BL13LJ2H	4		RC-FD538	0633
1,3	44	10.89 - 12.92	BL13JBC	4		RC-FD538	0633
1,3	44	10.89 - 12.96	BL13CFIJ6B	4		RC-FD538	0633
1,3	44	09.95 - 08.99	BL13EIFN	4		RC-FD544	0639
1,3	44	09.95 - 10.96	BL13EIFNJ4C	4		RC-FD544	0639
1,3	44	10.96 - 08.99	BL13EIFNJ4J	4		RC-FD544	0639
1,3	44	11.97 - 10.98	BL13EIFNJ4L	4		RC-FD544	0639
1,3	44	11.98 - 04.02	BL13EIFNJ4R	4		RC-FD1205	2584
1,3	44	09.99 - 10.00	BL13EIFNJ4Q	4		RC-FD1205	2584
1,3	44	11.00 - 04.02	BL13EIFNJ4T	4		RC-FD1205	2584
1,3	44	05.02 -	BL13BAJA	4		RC-FD1210	6317
1,3	49	05.75 - 08.83	KL13M	4		RC-FD532	0627
1,3	50	05.02 -	B13A9JA	4		RC-FD1210	6317
1,3	51	09.83 - 09.89	BL13HJPC	4		RC-FD509	0604
1,4	52	09.86 - 09.89	HL14LCFIF6A	4		RC-FD509	0604
1,4	52	09.86 - 09.89	HL14CFIF6C	4		RC-FD509	0604
1,4	52	09.86 - 09.89	HL14CFIF6A	4		RC-FD509	0604
1,4	52	10.89 - 12.92	HL14CFIF6E	4		RC-FD537	0632
1,4	54	09.83 - 09.89	HL14FUD	4		RC-FD509	0604
1,4	54	10.89 - 10.92	HL14FUG	4		RC-FD537	0632
1,4	55	09.83 - 09.89	HL14FUB	4		RC-FD509	0604
1,4	55	11.92 - 12.96	HL14FUF	4		RC-FD537	0632
1,4	59	05.02 -	ZH14FXJA	4		RC-FD807	8541
1,4	66	04.96 - 05.98	ZH14FHA/HE	4		RC-FD548	0642
1,4	66	06.98 - 12.99	ZH14FHA/HE	4		RC-FD1217	44250
1,4	66	01.00 - 05.00	ZH14FHA/HE	4		RC-FD807	8541
1,4	71	10.08 -	SPJA / SPJC	4		RC-FD807	8541
1,6	66	10.89 - 12.92	HL16LUH	4		RC-FD537	0632
1,6	66	01.93 - 12.95	ZH16L1G	4	DIN fitment	RC-FD546	0641
1,6 XR2	70	09.83 - 09.89	HL16GLUD	4		RC-FD509	0604
1,6 XR2	71	09.86 - 09.89	HL16GLUB	4		RC-FD509	0604
1,6	74	05.02 -	ZH16FYJA	4		RC-FD807	8541
1,6	74	08.02 -	ZH16FYJB	4		RC-FD807	8541
1,6 XR2i	76	10.89 - 12.92	HL16EFILJD	4		RC-FD826	8571
1,6	76	09.99 - 10.00	ZH16L2T	4		RC-FD546	0641
1,6	76	11.00 - 04.02	ZH16L2V	4		RC-FD546	0641
1,6 XR2i	81	10.89 - 12.92	HL16HLJC	4		RC-FD826	8571
1,6	88	10.08 -	HXJA / HXJB	4		RC-FD807	8541
1,6 Turbo RS	96	10.89 - 12.92	HL16TLHA	4		RC-FD826	8571
1,8	77	10.91 - 12.95	ZH18NRDB	4	DIN fitment	RC-FD546	0641
1,8	96	01.93 - 12.96	ZH18PRQC	4	DIN fitment	RC-FD546	0641
1,8 XR2i	96	09.95 - 12.96	ZH18PRQC	4	DIN fitment	RC-FD546	0641
2,0	110	11.04 -	ZH20N4JB	4		RC-FD1207	6984

Focus

1,4	55	08.98 - 08.00	ZH14FXDA	4		RC-FD807	8541
1,4	55	09.00 - 08.02	ZH14FXDB	4		RC-FD807	8541
1,4	55	09.02 - 08.03	ZH14FXDC	4		RC-FD807	8541
1,4	55	09.03 -	ZH14FXDD	4		RC-FD807	8541
1,4	59	11.04 -	ASDA/ASDB	4		RC-FD807	8541



kW

C
y
l

Stock-No.

FORD**Focus**

1,6 Zetec Rocam	70	08.98 - 07.05	C16LSEZ	4		RC-FD1210	6317
1,6	74	08.98 - 08.00	ZH16FYDA	4		RC-FD807	8541
1,6	74	09.00 - 08.02	ZH16FYDB	4		RC-FD807	8541
1,6	74	09.02 - 08.03	ZH16FYDC	4		RC-FD807	8541
1,6	74	09.03 - 07.04	ZH16FYDD	4		RC-FD807	8541
1,6	74	10.03 -	ZH16FYDG	4		RC-FD807	8541
1,6	74	08.04 -	ZH16 HWDA / HWDB	4		RC-FD807	8541
1,6	77	04.11 -	IQDB	4		RC-FD807	8541
1,6	85	08.04 -	ZH16HXDA	4		RC-FD807	8541
1,6 LPG	85	10.09 -	SIDA	4		RC-FD807	8541
1,6 Flexifuel	88	04.11 -	MUDA	4		RC-FD807	8541
1,6	92	04.11 -	PNDA	4		RC-FD807	8541
1,6	127	03.02 - 11.04	ALDA	4		RC-FD1207	6984
1,6	158	10.02 - 11.04	HMDA	4		RC-FD1207	6984
1,8	85	08.98 - 08.02	ZH18MEYDB	4		RC-FD808	8542
1,8	85	08.98 - 08.02	ZH18MEYDD	4		RC-FD808	8542
1,8	85	09.02 - 08.03	ZH18MEYDE	4		RC-FD808	8542
1,8	85	09.02 - 08.03	ZH18MEYDC	4		RC-FD808	8542
1,8	85	09.03 -	ZH18MEYDF	4		RC-FD808	8542
2,0	96	08.98 - 08.02	ZH20MEDDC	4		RC-FD808	8542
2,0	96	08.98 - 08.02	ZH20MEDDB	4		RC-FD808	8542
2,0	96	09.00 - 04.05	ZH20MEDDD	4		RC-FD808	8542
2,0	96	09.02 -	ZH20MEDDF	4		RC-FD808	8542

Fusion

1,3	55	08.04 -	ZH14FUJA	4		RC-FD807	8541
1,4	59	11.02 -	ZH14FXJA	4		RC-FD807	8541
1,6	74	11.02 -	ZH16FYJA	4		RC-FD807	8541

Galaxy

2,0	85	02.95 - 04.06	DH20NSE	4		RC-FD545	0640
2,0	85	02.95 - 04.06	DH20ZVSA	4		RC-FD1216	44234
2,3	103	11.02 - 03.06	DH23E5SB	4		RC-FD1212	44220
2,3	107	09.96 - 04.00	DH23Y5B	4	Semi-Direct	RC-FD1203	5405
2,3	107	05.00 - 10.02	DH23E5SA	4		RC-FD1212	44220
2,8	128	02.95 - 04.00	VV28AAA	6		RC-VW201	0932

Granada

2,0	76	07.79 - 04.85	TL20EK	4		RC-FD825	8569
2,0	77	05.85 - 12.89	TL20HNEL	4	DIN fitment	RC-FD825	8569
2,0	77	05.85 - 12.89	TL20HNEL	4	SAE fitment	RC-FD533	0628
2,0	85	05.85 - 08.89	TL20EFINRA	4	DIN fitment	RC-FD825	8569
2,0	85	05.85 - 08.89	TL20EFINRA	4	SAE fitment	RC-FD519	0614
2,0	85	11.92 - 09.94	DL20N9F	4		RC-FD817	8556
2,0	85	11.92 - 09.93	TL20EFINRA	4		RC-FD825	8569
2,0	85	11.92 - 09.93	TL20EFINRA	4		RC-FD519	0614
2,0	90	11.88 - 10.92	DL20EN9B	4		RC-FD817	8556
2,3	82	06.77 - 08.85	YY	6		RC-FD530	0625
2,4	92	11.88 - 10.92	TV24ARD	6		RC-FD830	7406
2,8	108	08.77 - 08.85	PRD	6	SAE fitment	RC-FD530	0625
2,8	110	10.86 - 10.92	TV28EFIPRE	6	SAE fitment	RC-FD530	0625
2,9	143	08.91 - 09.94	CP29BOA	6		RC-FD536	0631
3,0	102	02.72 - 08.77	EV30	6		RC-FD508	0603

KA

1,2	51	02.09 -	FP4	4		RC-FT1209	4746
1,3	37	09.96 - 08.98	BL13EFIL	4		RC-FD1215	44233
1,3	37	09.98 - 11.08	BL13EFIL	4		RC-FD1205	2584
1,3	44	09.96 - 09.98	BL13EIFN	4		RC-FD544	0639



kW

C
y
l

Stock-No.

FORD**KA**

1,3	44	09.98 - 11.08	J4D	4		RC-FD1205	2584
1,3	44	08.02 -	DU13BAJA	4		RC-FD1210	6317
1,3	51	08.02 - 11.08	BL1349A	4		RC-FD1210	6317
1,6 Sport	70	02.03 - 12.03	HL16SL9B	4		RC-FD1209	4063
1,6 Sport	70	01.04 - 11.08	HL16SL9B	4		RC-FD1210	6317
1,6 SreetKa	70	02.03 - 12.03	HL16SL9B	4		RC-FD1209	4063
1,6 SreetKa	70	02.03 - 11.08	HL16SL9B	4		RC-FD1210	6317

Maverick

2,0	91	02.01 -	YF	4		RC-FD808	8542
2,4	87	07.96 - 04.00	KA24	4		RC-RV303	8268
2,4	91	02.93 - 06.96	KA24E	4		RC-RV303	8268

Mondeo

1,6	65	02.93 - 08.95	ZH16L1J	4	DIN fitment	RC-FD546	0641
1,6	66	02.93 - 08.96	ZH16L1F	4	DIN fitment	RC-FD546	0641
1,6	66	09.96 - 12.98	ZH16EL1J	4	01.98>	RC-FD807	8541
1,6	66	09.96 - 12.98	ZH16EL1J	4	DIN fitment	RC-FD546	0641
1,6	70	05.98 - 09.00	ZH16EL1L	4	DIN fitment	RC-FD546	0641
1,6	81	03.07 -	RHBA	4		RC-FD807	8541
1,6	88	07.10 -	KGBA	4		RC-FD807	8541
1,6	92	03.07 -	PNBA	4		RC-FD807	8541
1,8	81	10.00 -	ZH18CGBB	4		RC-FD1207	6984
1,8	81	10.00 -	ZH18CGBA	4		RC-FD1207	6984
1,8	82	07.94 - 08.96	RKB	4		RC-FD546	0641
1,8	85	02.93 - 09.00	ZH18RKA	4		RC-FD546	0641
1,8	85	03.93 - 08.96	ZH18RKA	4	DIN fitment	RC-FD546	0641
1,8	85	09.96 - 09.00	ZH18RKB	4	DIN fitment: >04.98	RC-FD546	0641
1,8	85	09.96 - 09.00	ZH18RKB	4	05.95>	RC-FD808	8542
1,8	92	10.00 -	ZH18CHBB	4		RC-FD1207	6984
1,8	92	10.00 -	ZH18CHBA	4	M4 fitment	RC-FD1207	6984
2,0	96	09.96 - 09.00	ENGB / ENGA	4	DIN fitment: >04.98	RC-FD546	0641
2,0	96	09.96 - 09.00	ENGB / ENGA	4	05.95>	RC-FD808	8542
2,0	100	02.93 - 08.96	ZH20NGA	4	DIN fitment	RC-FD546	0641
2,0	107	10.00 -	CJBA / CJBB / CJBD	4		RC-FD1207	6984
2,5	125	09.94 - 09.00	MP25SEA	6		RC-FD1204	7701
2,5	125	01.00 - 09.00	MP25NSEA	6		RC-FD1204	7701
2,5	125	10.00 - 08.07	MP25LCBD	6		RC-FD1211	1644
2,5 ST200	151	04.99 - 09.00	MP25SGA	6		RC-FD1204	7701
3,0	150	09.04 - 08.07	REBA	6		RC-FD1214	44226
3,0 ST220	166	04.02 - 08.07	MEBA	6		RC-FD1214	44226

Orion

1,3	44	08.88 - 08.90	BL13LJLA	4		RC-FD804	8537
1,3	44	09.90 - 08.92	BL13JBE	4		RC-FD538	0633
1,3	44	09.90 - 08.93	BL13CFI6A	4		RC-FD538	0633
1,3	51	09.83 - 02.86	HL13H	4		RC-FD509	0604
1,4	52	09.90 - 08.93	HL14F6F	4		RC-FD537	0632
1,4	54	04.87 - 08.90	HL14CFIF6B	4		RC-FD509	0604
1,4	54	04.87 - 08.90	HL14CFIF6D	4		RC-FD509	0604
1,4	54	08.90 - 08.93	HL14CFIF4B	4		RC-FD537	0632
1,4	55	03.86 - 08.90	HL14HFUA	4		RC-FD509	0604
1,6	59	09.83 - 02.86	HL16L	4		RC-FD509	0604
1,6	65	03.86 - 08.90	HL16ILUG	4		RC-FD509	0604
1,6	66	04.87 - 08.90	HL16L4B	4		RC-FD509	0604
1,6	66	09.90 - 08.93	HL16HLUK	4		RC-FD537	0632
1,6	66	09.91 - 08.93	ZH16L1E	4	DIN fitment	RC-FD546	0641
1,6	75	04.87 - 08.90	HL16EFILJB	4		RC-FD826	8571
1,6	75	04.87 - 08.90	HL16EFILJB	4		RC-FD509	0604



kW

C
y
l

Stock-No.

FORD**Orion**

1,6	77	09.83 - 02.86	HL16EFI	4		RC-FD509	0604
1,6	77	03.86 - 08.90	HL16EFILRB	4		RC-FD826	8571
1,6	77	03.86 - 08.90	HL16EFILRB	4		RC-FD509	0604
1,6	77	09.90 - 08.92	HL16EFILJF	4		RC-FD826	8571
1,8	77	09.91 - 08.93	ZH18NRDA	4	DIN fitment	RC-FD546	0641
1,8	96	09.91 - 08.93	ZH18PRQB	4	DIN fitment	RC-FD546	0641

P100 (Sierra)

2,0	57	03.87 - 12.94	HL20HNAE	4		RC-FD825	8569
-----	----	---------------	----------	---	--	----------	------

Probe

2,0	85	06.92 - 12.97	JA20FS	4		RC-ZX29	9925
2,2	82	02.88 - 12.89	LC22	4		RC-FD1201	5402
2,2 Turbo GT	108	02.88 - 05.92	LC22	4		RC-FD1201	5402
2,5 GT	119	06.92 - 12.97	JB25KL	6		RC-ZE28	9874
2,5 V6 24V	120	12.94 - 03.98	KL	6		RC-ZE32B	8863
3,0	104	06.89 - 05.92	U30	6		RC-FD1202	5403

Puma

1,4	65	02.98 - 12.01	ZH14EFI	4	>05.98	RC-FD807	8541
1,4	65	09.98 - 12.01	ZH14EFI	4	01.98>	RC-FD548	0642
1,6	76	07.00 - 05.02	ZH16SE	4		RC-FD807	8541
1,7	92	05.97 - 05.02	ZH17EFI	4	>01.98	RC-FD807	8541
1,7	92	09.98 - 05.02	ZH17EFI	4		RC-FD548	0642

Scorpio

1,8	66	10.84 - 10.88	TL18REC	4	DIN fitment	RC-FD825	8569
1,8	66	10.84 - 10.88	TL18REC	4	SAE fitment	RC-FD533	0628
2,0	74	10.84 - 02.90	TL20EFINRC	4		RC-FD520	0615
2,0	74	10.84 - 02.90	TL20HNER	4		RC-FD520	0615
2,0	77	10.84 - 02.90	N8D	4		RC-FD520	0615
2,0	77	10.84 - 02.90	TL20HNEL	4	DIN fitment	RC-FD825	8569
2,0	77	10.84 - 02.90	TL20HNEL	4	SAE fitment	RC-FD533	0628
2,0	85	10.84 - 02.90	TL20EFINRA	4	DIN fitment	RC-FD825	8569
2,0	85	10.84 - 02.90	TL20EFINRA	4	SAE fitment	RC-FD519	0614
2,0	85	10.84 - 02.90	NRI	4		RC-FD520	0615
2,0	85	02.92 - 09.94	DL20N9F	4		RC-FD817	8556
2,0	85	10.94 - 08.99	DL20NSD	4		RC-FD1208	4062
2,0	88	11.88 - 09.94	DL20EFIN9D	4		RC-FD817	8556
2,0	90	11.88 - 08.92	DL20EN9B	4		RC-FD817	8556
2,0	100	10.94 - 05.96	DH20N3A	4	Semi-Direct	RC-FD1203	5405
2,3	108	06.96 - 08.99	DH23Y5A	4	Semi-Direct	RC-FD1203	5405
2,4	92	10.86 - 09.94	TV24ARD	6		RC-FD830	7406
2,4	96	10.86 - 02.90	TV24ARC	6	DIN fitment	RC-FD830	7406
2,4	96	10.86 - 02.90	TV24ARC	6	SAE fitment	RC-FD820	8562
2,8	110	04.85 - 11.86	TV28EFIPRE	6	SAE fitment	RC-FD820	8562
2,9	107	10.86 - 09.94	TV29EFIBRF	6		RC-FD830	7406
2,9	107	10.86 - 09.94	TV29EFIBRE	6		RC-FD830	7406
2,9	107	11.88 - 08.92	TV29EFIBRE	6	DIN fitment	RC-FD830	7406
2,9	107	11.88 - 09.94	TV29EFIBRF	6	SAE fitment	RC-FD820	8562
2,9	107	11.88 - 08.92	TV29EFIBRE	6	SAE fitment	RC-FD820	8562
2,9	110	10.86 - 08.92	TV29EFIBRC	6	DIN fitment: 12.87>	RC-FD820	8562
2,9	110	10.90 - 08.92	TV29EFIBRC	6		RC-FD830	7406
2,9	110	10.94 - 06.96	TV29BRG	6		RC-FD830	7406



kW

C
y
l

Stock-No.

FORD**Sierra**

1,3	44	10.82 - 02.87	JCT	4		RC-FD825	8569
1,6	55	10.82 - 02.87	LCT	4		RC-FD825	8569
1,6	55	10.82 - 02.87	LCS	4		RC-FD825	8569
1,6	55	12.83 - 02.87	LSD	4		RC-FD825	8569
1,6	55	03.87 - 09.91	TL16LSE	4		RC-FD825	8569
1,6	59	10.89 - 03.93	HL16L6B	4		RC-FD503	0598
1,8	59	10.87 - 06.88	TL18LRED	4		RC-FD813	8552
1,8	64	10.91 - 03.93	HL18R2C	4		RC-FD521	0616
1,8	66	10.82 - 02.87	REB	4	DIN fitment	RC-FD825	8569
1,8	66	10.82 - 02.87	REB	4	SAE fitment	RC-FD533	0628
1,8	66	03.87 - 09.89	TL18R2A	4		RC-FD825	8569
1,8	66	03.87 - 09.89	TL18R2A	4		RC-FD521	0616
1,8	66	10.89 - 09.91	HL18RED	4		RC-FD825	8569
1,8	66	10.89 - 09.91	HL18RED	4	SAE fitment	RC-FD533	0628
2,0	77	08.82 - 02.87	NET	4	DIN fitment	RC-FD825	8569
2,0	66	08.82 - 09.84	NYT	6		RC-FD530	0625
2,0	74	08.85 - 02.87	NRD	4		RC-FD519	0614
2,0	74	03.87 - 09.89	TL20NEJ	4		RC-FD825	8569
2,0	74	03.87 - 09.88	TL20N4B	4		RC-FD825	8569
2,0	77	08.82 - 02.87	NET	4	SAE fitment	RC-FD533	0628
2,0	77	03.87 - 09.89	TL20NES	4		RC-FD825	8569
2,0	80	10.88 - 12.92	DL20N8A	4		RC-FD817	8556
2,0	85	10.84 - 02.87	NR2	4		RC-FD519	0614
2,0	85	03.87 - 05.89	TL20N4I	4		RC-FD825	8569
2,0	88	10.88 - 03.93	DL20N4A	4		RC-FD825	8569
2,0	88	06.89 - 03.93	DL20N9C	4		RC-FD817	8556
2,0	150	03.87 - 10.90	CH20N5B	4		RC-FD901	8589
2,0	162	10.89 - 03.93	CH20N5D	4		RC-FD901	8589
2,0	162	10.89 - 03.93	CH20N5C	4		RC-FD901	8589
2,3	84	08.82 - 02.87	YYT	6		RC-FD530	0625
2,8 XRi	105	08.82 - 02.87	PR6	6	SAE fitment	RC-FD820	8562
2,8 XR4i	110	10.82 - 02.87	PRT	6		RC-FD530	0625
2,8	110	04.84 - 02.87	PRT	6		RC-FD530	0625
2,8 XR4i	110	03.87 - 09.89	TV28PRG	6		RC-FD530	0625
2,9 XRi	107	10.88 - 03.93	TV29B4B	6		RC-FD530	0625
2,9 XRi	107	10.88 - 09.91	TV29B4C	6		RC-FD530	0625
2,9	110	10.88 - 09.91	TV29B4A	6		RC-FD830	7406

Tourneo

1,8	85	06.02 -	EYP	4		RC-FD808	8542
-----	----	---------	-----	---	--	----------	------

Transit









1,6	48	10.85 - 07.87	LAT	4		RC-FD824	8568
2,0	57	10.85 - 03.91	NAT	4	>09.88	RC-FD825	8569
2,0	57	10.85 - 03.91	NAT	4	10.88>	RC-FD824	8568
2,0	66	04.91 - 07.94	NBA	4		RC-FD824	8568
2,0	72	04.91 - 07.94	NCA	4		RC-FD824	8568
2,0	84	08.94 - 12.99	NSF	4		RC-FD1208	4062
2,3	107	01.00 -	E5FA	4	nd	RC-FD1203	5405
2,9	107	11.91 - 07.94	BRT	6		RC-FD830	7406

Transit / Torneo Connect

1,8	85	06.02 -	EYPA / EYPC / EYPD	4		RC-FD808	8542
-----	----	---------	--------------------	---	--	----------	------

FSO (DAEWOO)**125**

1,3	47	10.67 - 10.87	116C076	4		RC-DW1206	5976
1,5	55	10.67 - 10.87	115C076	4		RC-DW1206	5976

							
FSO (DAEWOO)							
126P							
0,6	17	09.72 - 12.76	126A1000	2		RC-FT1204	6969
0,7	18	09.81 - 09.00	126A1048	2		RC-FT1204	6969
0,7	22	09.81 - 12.91	126A1048	2		RC-FT1204	6969
Caro (Polonez)							
1,4		01.94 -	-	4		RC-RV413	0888
1,5	55	08.88 - 07.92	138ASAB	4		RC-VX402	0973
1,5	55	10.89 - 07.92	138ACAE	4		RC-VX402	0973
1,5	55	08.92 - 09.95	138ABN2	4		RC-VX402	0973
1,5	60	08.92 - 08.94	138AN1	4		RC-VX402	0973
1,6	57	10.93 - 07.97	147CK46	4		RC-DW1205	6296
1,6	64	08.88 - 07.92	116C070	4		RC-ZX19	9922
Polonez							
1,3	48	05.78 - 11.82	116C056	4		RC-DW1206	5976
1,5	55	05.78 - 02.84	115C056	4		RC-DW1206	5976
1,5	59	11.80 - 07.88	115C074	4		RC-DW1206	5976
1,5 Turbo	70	09.81 - 07.92	115C082	4		RC-DW1206	5976
1,6	64	02.87 - 10.95	116C070	4		RC-VX402	0973
Prima (Polonez)							
1,4	76	08.92 - 10.98	EL14K4F	4		RC-VX402	0973
1,6	57	10.93 - 10.98	147CK46	4		RC-DW1205	6296
GAZ (VOLGA)							
GAZ (VOLGA) various							
2217 2,3 Sobol	96	-	3M3-4062.9	4	without spark plug stick	RC-MX1204	4946
2217 2,3 Sobol	96	-	3M3-4062.9	4	inclusive spark plug stick	RC-MX1206	4052
2410 2,3	73	-	3M3-402	4		RC-MX1203	4945
24 2,4	70	-	3M3-24D	4		RC-MX1203	4945
24/2402 2,5 Gazel		01.93 -	-	4		RC-MX1203	4945
3102 2,4 16V	67	02.72 - 01.93	-	4		RC-MX1203	4945
3102 2,4 16V	77	02.72 - 01.93	-	4		RC-MX1203	4945
3102 2,5 Gazel		01.93 -	ZM402.10	4		RC-MX1203	4945
3102 (31021; 31024; 31029)	73	-	3M3-204	4		RC-MX1203	4945
3102 (31029) 2,5 Gazel 16V		01.93 -	ZMZ4062.10	4	inclusive spark plug stick	RC-MX1206	4052
3102 (31029) 2,5 Gazel 16V		01.93 -	ZMZ4062.10	4	without spark plug stick	RC-MX1204	4946
3110 (31105) 2,3 8V	73	-	3M3-401	4		RC-MX1203	4945
3110 (31105) 2,3 Gazel	96	10.93 - 08.01	3M3-4062.9	4	inclusive spark plug stick	RC-MX1206	4052
3110 (31105) 2,3 Gazel	96	10.93 - 08.01	3M3-4062.9	4	without spark plug stick	RC-MX1204	4946
3110 (31105) 2,5 Gazel 16V		01.95 -	ZMZ4062.10	4	inclusive spark plug stick	RC-MX1206	4052
3110 (31105) 2,5 Gazel 16V		01.95 -	ZMZ4062.10	4	without spark plug stick	RC-MX1204	4946
3111 2,3		01.00 -	3M3-4062.10			RC-MX1204	4946
3302; 2752 Gazel 16V	107	-	ZMZ-4061.10; 4063.9	4	inclusive spark plug stick	RC-MX1206	4052
3302; 2752 Gazel 16V	107	-	ZMZ-4061.10; 4063.9	4	without spark plug stick	RC-MX1204	4946
33021; 2705; 3221 Gazel 8V	71	-	ZMZ-4025.10; 4026.9	4		RC-MX1203	4945
33027; 33021; 2705; 3221 Gazel		-	3M3-401	4		RC-MX1203	4945
405; 406; 409 16V		-	-			RC-MX1209	9179
Gazel							
2,3	72	06.00 -	ZMZ406310	4		RC-MX1207	4056
2,3	74	06.00 -	ZMZ406110	4		RC-MX1207	4056
2,3 Gazel		01.98 -	ZMZ4062.10	4	Bosch coil	RC-MX1207	4056
2,4 Gazel	66	10.93 - 08.01	-	4	inclusive spark plug stick	RC-MX1206	4052
2,4 Gazel	66	10.93 - 08.01	-	4	without spark plug stick	RC-MX1204	4946
2,4 Gazel	96	10.93 - 08.01	-	4	inclusive spark plug stick	RC-MX1206	4052



kW

C
y
l

Stock-No.

GAZ (VOLGA)

Gazel							
2,4 Gazel	96	10.93 - 08.01	-	4	without spark plug stick	RC-MX1204	4946
Volga							
2,4 Luxus	59	02.93 -	ZMZ402110	4		RC-MX1203	4945
2,4	66	04.04 -	ZMZ402110	4		RC-MX1208	4057
2,5 Luxury	110	04.00 - 09.04	ZMZ405210	4		RC-MX1206	4052
		-	ZMZ406.10	4		RC-MX1208	4057
		-	ZMZ406.10		Bosch coil	RC-MX1207	4056

HONDA

Accord							
1,6 GL	57	01.79 - 12.79	EL10KB	4		RC-HE32	9105
1,6 GL	57	01.79 - 12.79	EL10KS	4		RC-HE32	9105
1,6 GL	57	01.79 - 12.79	EL10KW	4		RC-HE32	9105
1,6 GL	58	01.78 - 12.78	EL1	4		RC-HE32	9105
1,6 GL	58	01.80 - 12.81	EL12KW	4		RC-HE32	9105
1,6 GL	58	01.80 - 12.81	EL12KS	4		RC-HE32	9105
1,6 GL	58	01.80 - 12.81	EL12KB	4		RC-HE32	9105
1,6	59	10.76 - 09.78	EG8	4		RC-HE32	9105
1,6 SL	59	10.76 - 12.77	EL14KB	4		RC-HE32	9105
1,6 SL	59	10.76 - 12.77	EL14KG	4		RC-HE32	9105
1,6 SL	59	10.76 - 12.77	EL14KS	4		RC-HE32	9105
1,6 SL	59	10.76 - 12.77	EL14KW	4		RC-HE32	9105
1,6	59	10.78 - 12.81	EL1	4		RC-HE32	9105
1,6 EX	59	01.80 - 12.81	EL14KB	4		RC-HE32	9105
1,6 EX	59	01.80 - 12.81	EL14KW	4		RC-HE32	9105
1,6 EX	59	01.82 - 12.83	EL16KB	4		RC-HE32	9105
1,6 Economy	65	01.82 - 12.83	EL16KW	4		RC-HE32	9105
1,6 EX	65	01.82 - 12.83	EL16KB	4		RC-HE32	9105
1,6 EX	65	01.82 - 12.83	EL16KG	4		RC-HE32	9105
1,6 Luxe	65	01.82 - 12.83	EL16KS	4		RC-HE32	9105
1,6 Luxe	65	01.82 - 12.83	EL16KW	4		RC-HE32	9105
1,6 Luxe	65	01.82 - 12.83	EL16KG	4		RC-HE32	9105
1,6 EX	65	09.83 - 10.85	EZ	4		RC-VX402	0973
1,8	73	01.84 - 12.85	ET1	4		RC-VX402	0973
1,8 S	85	01.96 - 09.98	F18A	4		RC-HE80	8379
1,8 Vtec	100	10.98 - 12.02	F18B2	4		RC-HE73	8474
1,9	85	02.96 - 10.98	F18A3	4		RC-HE80	8379
2,0	66	01.90 - 03.93	F20A6	4		RC-RV603	8496
2,0	75	01.86 - 12.89	A20A1	4		RC-RV304	8269
2,0	75	01.87 - 12.87	A20A2	4		RC-RV304	8269
2,0	81	01.91 - 12.92	F20A2	4		RC-RV603	8496
2,0	85	01.86 - 12.89	A20A3	4		RC-RV304	8269
2,0	85	01.93 - 12.95	F20Z2	4		RC-HE80	8379
2,0	90	01.86 - 12.89	A20A4	4		RC-RV304	8269
2,0	96	01.93 - 12.95	F20Z1	4		RC-HE89	5049
2,0 ES	96	01.96 - 09.98	F20Z1	4		RC-HE80	8379
2,0	98	01.88 - 12.89	B20A8	4		RC-RV603	8496
2,0	98	01.90 - 12.92	F20A4	4		RC-RV603	8496
2,0 LS	98	08.93 - 12.97	F20B3	4		RC-HE80	8379
2,0 ES	98	01.94 - 10.97	F20B3	4	Chassis No CE2	RC-HE80	8379
2,0	98	01.94 - 10.97	F20B3	4	Chassis No CD9	RC-RV1302	5400
2,0	101	01.86 - 12.86	A20A2	4		RC-RV304	8269
2,0	101	01.87 - 12.89	B20A2	4		RC-RV603	8496
2,0	101	09.93 - 02.98	F20B3	4		RC-HE80	8379
2,0 Vtec	108	10.98 - 12.02	F20B6	4		RC-HE76	8655
2,0 Vtec	108	04.99 - 12.02	F20B6	4		RC-HE73	8474
2,0	116	01.89 - 12.97	G20A	5		RC-HE68A	5047



kW

C
y
l

Stock-No.

HONDA**Accord**

2,0		-	F20B	4		RC-HE89	5049
2,0	140	01.93 - 12.01	H22A	4		RC-HE89	5049
2,2 LX	110	01.90 - 12.92	F22A8	4		RC-HE80	8379
2,2 LX	110	01.90 - 12.92	F22A7	4		RC-HE80	8379
2,2 EX	110	01.90 - 12.91	F22A3	4		RC-HE80	8379
2,2	110	01.91 -	F20A2	4		RC-HE57	8610
2,2	110	01.91 -	F22A8	4		RC-HE57	8610
2,2 LS	110	01.93 - 12.93	F22A8	4		RC-HE80	8379
2,2	110	01.93 - 12.93	F22A7	4		RC-HE80	8379
2,2	110	08.93 - 12.97	F22B5	4	Chassis No CD7	RC-HE89	5049
2,2 ES	110	08.93 - 12.97	F22B5	4	Chassis No CE1	RC-HE80	8379
2,2 LS	110	01.94 - 10.97	F22B5	4	Chassis No CE1	RC-HE80	8379
2,2 Vtec	110	01.96 - 09.98	F22Z2	4		RC-HE73	8474
2,2 Vtec	110	01.96 - 09.98	F22Z2	4		RC-HE80	8379
2,3	113	11.00 - 12.02	F23Z5	4		RC-HE71	8650
2,7 V6 EFI		01.95 - 12.97	C27A4	6		RC-HE75	8516
3,0 Vtec	147	01.98 - 12.00	J30A1	6		RC-HE86	3386

Ascot

2,0		-	G20A	5		RC-HE90	5070
2,0		-	G20 / CE4	5		RC-HE68A	5047
2,5		-	G25A	5		RC-HE90	5070

Ballade

1,3	33	10.79 - 09.82	EN2	4		RC-HE32	9105
1,3 Hot S	44	10.79 - 09.82	EN1	4		RC-HE32	9105
1,5	62	04.86 - 12.87	EW2	4		RC-EH1201	9057

Civic

1,2 L	40	05.78 - 12.79	EB2	4		RC-HE32	9105
1,2	44	05.78 - 12.79	EB3	4		RC-HE32	9105
1,3 EX	44	01.80 - 12.83	EN1	4		RC-HE32	9105
1,3	51	03.81 - 12.83	EN1	4		RC-HE32	9105
1,3	55	01.88 - 12.91	D13B1	4		RC-HE53	8573
1,3	55	09.89 - 09.91	D13B2	4		RC-HE53	8573
1,3	55	01.92 - 10.95	D13B2	4		RC-RV603	8496
1,4 Joker Dream	55	11.95 - 10.98	D14A3	4		RC-HE73	8474
1,4	55	11.95 - 10.98	D14A4	4		RC-HE73	8474
1,4	55	01.97 - 12.98	D14A7	4		RC-HE73	8474
1,4 S	55	11.98 - 10.00	D14Z3	4		RC-HE73	8474
1,4	55	11.98 - 03.01	D14Z1	4		RC-HE73	8474
1,4	66	01.88 - 12.91	D14A1	4		RC-RV603	8496
1,4 LS	66	11.95 - 10.98	D14A4	4		RC-HE73	8474
1,4	66	11.95 - 12.96	D14A2	4		RC-HE73	8474
1,4 S	66	01.97 - 10.98	D14A8	4		RC-HE73	8474
1,4	66	01.97 - 10.98	D14A4	4		RC-HE73	8474
1,4 Vtec	66	02.98 - 12.98	D14A8	4		RC-HE73	8474
1,4	66	11.98 - 03.01	D14Z2	4		RC-HE73	8474
1,4	66	02.01 - 09.05	D14Z5 / D14Z6	4		RC-HE71	8650
1,5 LS	61	01.92 - 12.92	D15B2	4		RC-HE73	8474
1,5	62	01.84 - 12.87	EW2	4		RC-EH1201	9057
1,5	63	10.84 - 12.87	EW2	4		RC-EH1201	9057
1,5	66	01.88 - 09.91	D15B	4		RC-HE53	8573
1,5	66	01.88 - 10.95	D15B2	4		RC-RV603	8496
1,5 DX	66	01.92 - 12.92	D15B2	4		RC-HE73	8474
1,5 VEi Vtec	66	01.92 - 10.95	D15Z1	4	Chassis No EG,EG4,EG8	RC-HE73	8474
1,5 VEi Vtec	66	01.92 - 10.95	D15Z1	4	Chassis Type: EG,EH	RC-RV603	8496
1,5 LS	66	01.93 - 10.95	D15B2	4		RC-HE73	8474
1,5	66	08.93 - 10.95	D15B2	4		RC-HE73	8474
1,5 Bali	66	08.94 - 10.95	D15B2	4		RC-HE73	8474



kW

C
y
l

Stock-No.

HONDA**Civic**

1,5 VEi Vtec	66	11.95 - 12.96	D15Z3	4		RC-HE73	8474
1,5	69	01.88 - 09.91	D15B	4		RC-HE53	8573
1,5 GL	69	01.88 - 12.91	D15B2	4		RC-HE73	8474
1,5 DXi	69	08.93 - 12.95	D15B7	4		RC-HE73	8474
1,5	74	02.94 - 12.95	D15B7	4		RC-HE73	8474
1,5 Vtec	84	11.95 - 03.01	D15Z6	4		RC-HE73	8474
1,5 Vtec	84	01.97 - 12.00	D15Z8	4		RC-HE73	8474
1,5		01.74 - 12.80	-	4		RC-HE32	9105
1,6 LSi	77	01.96 - 12.00	D16Y7	4		RC-HE73	8474
1,6	79	06.89 - 09.90	D16A6	4		RC-RV603	8496
1,6	81	01.88 - 12.89	D16A6	4		RC-RV603	8496
1,6	83	11.95 - 12.96	D16Y3	4		RC-RV603	8496
1,6 LS	85	01.97 - 12.98	D16B2	4		RC-HE73	8474
1,6	92	09.83 - 12.87	ZC1	4		RC-RV604	8499
1,6 Vtec	92	01.92 - 10.95	D16Z6	4		RC-HE73	8474
1,6	92	01.94 -	D16Z9	4		RC-HE76	8655
1,6 SRI Vtec	93	11.95 - 12.96	D16Y2	4		RC-HE73	8474
1,6	96	09.87 - 09.91	D16A7	4		RC-HE53	8573
1,6 VTi Vtec	118	01.92 - 03.01	B16A2	4		RC-HE57	8610
1,6 VTi	118	11.95 - 03.01	B16A2	4		RC-HE64	8246
1,6 LS	118	02.96 - 03.01	D16B2	4		RC-HE64	8246
1,8 VTi Vtec	124	01.97 - 10.00	D18C4	4		RC-HE73	8474
1,8 VTi Vtec	124	02.98 - 12.00	B18C4	4		RC-HE73	8474

Concerto

1,4	61	10.89 - 10.92	D14A1	4		RC-RV603	8496
1,4	66	10.89 - 10.92	D14A1	4		RC-HE53	8573
1,5	66	10.89 - 05.95	D15B2	4		RC-HE53	8573
1,6	81	11.92 - 05.95	D16Z2	4		RC-RV603	8496
1,6	90	08.89 - 03.95	D16A8	4		RC-HE81	8518

CR-V

2,0	94	10.95 - 01.99	B20Z1	4		RC-HE82	5048
2,0 SE	98	04.99 - 02.02	B20B	4		RC-HE82	5048
2,0 RVSi	108	04.99 - 02.02	B20Z3	4		RC-HE82	5048

CRX

1,6 ESI	91	10.87 - 02.92	D16Z5	4		RC-HE81	8518
1,6	92	06.92 - 04.98	D16Z6	4		RC-HE76	8655
1,6 Vtec	110	10.89 - 02.92	B16A1	4		RC-HE57	8610

HR-V

1,6	77	02.99 - 12.06	D16W1	4		RC-HE76	8655
1,6 Vtec	91	04.99 - 12.06	D16W5	4		RC-HE76	8655

Inspire

2,0		-	G20A	5		RC-HE68A	5047
2,5		-	G25A	5		RC-HE68A	5047

Jazz

1,2	33	01.84 - 10.86	ER1; ER2	4		RC-HD408	0710
1,2	40	01.84 - 10.86	ER4	4		RC-HE33	9107

Legend

2,5	110	10.85 - 12.87	C25A1	6		RC-RV605	7384
2,5	127	10.85 - 12.87	C25A2	6		RC-RV605	7384
2,7	124	05.87 - 12.90	C27A1	6		RC-HE75	8516

Logo

1,3	48	02.99 - 11.01	D13B7	4		RC-HE73	8474
1,3 SE	48	04.99 - 11.01	D13B7	4		RC-HE73	8474



kW

C
y
l

Stock-No.

HONDA**Odyssey**

2,3	110	02.12 - 03.12	F23A	4		RC-HE73	8474
-----	-----	---------------	------	---	--	---------	------

Prelude

2,0	80	10.87 - 09.91	B20A3	4		RC-RV304	8269
2,0	84	10.87 - 09.91	B20A4	4		RC-RV304	8269
2,0	98	10.91 - 10.00	F20A4	4		RC-HE89	5049
2,0	101	01.85 - 09.87	B20A1	4		RC-HE77	8240
2,0 EX	101	01.86 - 09.87	B20A1	4		RC-HE77	8240
2,0	101	10.90 - 09.91	B20A9	4		RC-EH1202	6370
2,0	103	10.87 - 09.90	B20A5	4		RC-EH1202	6370
2,0	103	10.90 -1992-01	B20A9	4		RC-EH1202	6370
2,0	110	10.87 - 09.90	B20A7	4		RC-EH1202	6370
2,0	110	10.87 - 09.90	B20A5	4		RC-EH1202	6370
2,2 VTI Vtec	136	10.93 - 09.96	H22A2	4		RC-HE89	5049
2,2 16V	136	10.96 - 10.00	H22A5	4		RC-HE89	5049
2,2 16V	147	10.96 - 10.00	H22A5	4		RC-RV1302	5400
2,3 16V	118	02.92 - 09.96	H23A2	4		RC-HE77	8240

Quintet

1,6 SR	59	10.80 - 12.83	EP16	4		RC-HE32	9105
--------	----	---------------	------	---	--	---------	------

Rafaga

2,0		-	G20A	5		RC-HE90	5070
2,0		-	G20A	5		RC-HE68A	5047
2,5		-	G25A			RC-HE90	5070

Saber

2,0		-	G20A	5		RC-HE68A	5047
2,5		-	G25A	5		RC-HE68A	5047

Shuttle

2,2 LS	110	03.95 - 12.97	F22B8	4		RC-HE80	8379
2,2 ES	110	06.95 - 12.97	F22B8	4		RC-HE80	8379

Torneo

2,0		-	F20B	4		RC-HE89	5049
2,2		-	H22A	4		RC-HE89	5049

Vigor

2,0		-	G20A	5		RC-HE68A	5047
2,5		-	G25A	5		RC-HE68A	5047

HYUNDAI**Accent**

1,3	40	09.95 - 05.98		4		RC-FT444	0691
1,3	44	07.94 - 08.99	G4EH	4		RC-FT444	0691
1,3	55	07.94 - 08.99	G4DH	4		RC-FT444	0691
1,3	55	09.99 - 08.06	G4DA/G4EA	4		RC-HD1202	5506
1,3	62	08.02 - 11.05	G4EH	4		RC-HD1202	5506
1,3	63	09.94 - 08.99	G4EH	4		RC-FT444	0691
1,3	63	09.99 - 02.03	G4EA	4		RC-HD1202	5506
1,4	71	11.05 -	G4EE	4		RC-HD1206	44332
1,5	65	09.94 - 10.02	G4EK	4		RC-FT444	0691
1,5	66	09.99 -	G4EB	4		RC-FT444	0691
1,5	73	12.95 - 12.96	G4ER	4		RC-FT444	0691
1,5	73	12.96 - 12.99	G4ER	4		RC-HD1206	44332
1,5	73	09.99 - 10.02	G4FK	4		RC-FT444	0691
1,5	75	09.99 - 10.02	G4FK	4		RC-FT444	0691
1,5	75	09.00 - 02.03	G4EC-G	4		RC-HD1206	44332



kW

C
y
l

Stock-No.

HYUNDAI**Accent**

1,6	77	10.02 - 02.03	G4ED	4		RC-HD407	0709
1,6	77	10.02 - 11.05	G4ED-G	4		RC-HD1206	44332
1,6	82	11.05 -	G4ED	4		RC-HD1206	44332

Atos

1,0	40	11.97 - 07.03	G4HC	4		RC-HD301	8300
1,0	43	09.00 - 07.03	G4AE	4		RC-FT444	0691
1,1	43	06.03 - 01.07	G4HD	4		RC-KA1204	6299
1,1	46	09.05 -	G4HG	4		RC-HD1202	5506

Coupé

1,5	85	04.94 - 05.96	G4EK-TC	4		RC-MX1202	7700
1,6	84	12.96 - 04.02	4G61	4		RC-HD1206	44332
1,6	85	03.98 - 04.02	G4GR	4		RC-HD1206	44332
1,6	77	03.02 - 08.09	G4ED-G	4		RC-HD1206	44332
1,6	79	03.02 - 08.09	G4ED-G	4		RC-HD1206	44332
1,6	84	11.96 - 01.02	G4GR	4		RC-HD407	0709
2,0	101	04.96 - 01.02	G4DF	4		RC-HD407	0709
2,0	102	03.02 - 08.09	G4GC-G	4		RC-HD407	0709
2,7	123	02.02 -	G6BAG	6		RC-HD1205	6302

Elantra

1,5	62	12.90 - 05.95	G4DJ	4		RC-HD408	0710
1,6	66	09.95 - 07.06	G4DR	4		RC-HD407	0709
1,6	77	08.03 -	G4ED-G	4		RC-HD1206	44332
1,6	79	06.00 - 07.06	G4ED-G	4		RC-HD1206	44332
1,6	84	12.90 - 05.95	G4CR	4		RC-HD409	0711
1,6	84	06.95 - 05.00	G4GR	4		RC-HD407	0709
1,6	84	06.00 - 07.06	G4GR	4		RC-HD1206	44332
1,8	93	06.92 - 12.93	G4CN	4		RC-HD1201	2570
1,8	94	06.95 - 05.00	G4GM	4		RC-HD409	0711
1,8	94	11.95 - 09.00	G4GM	4		RC-HD407	0709
1,8	97	06.00 - 07.06	G4BB	4		RC-HD407	0709
2,0	104	06.00 - 07.06	G4GC	4		RC-HD407	0709

Excel

1,3	55	09.99 -	G4DA	4		RC-HD1202	5506
1,3	63	09.94 - 08.99	G4EH	4		RC-FT444	0691
1,3	63	09.99 - 02.03	G4EA	4		RC-HD1202	5506
1,5	62	09.89 - 08.94	G4DJ	4		RC-HD408	0710
1,5	65	09.94 - 02.03	G4EK	4		RC-FT444	0691

Getz

1,1	46	08.02 - 08.05	G4HD	4		RC-KA1204	6299
1,1	49	09.05 -	G4HD	4		RC-KA1204	6299
1,3	60	08.02 - 01.04	G4EA	4		RC-HD1202	5506
1,3	63	08.02 - 01.04	G4EA	4		RC-HD1202	5506
1,4	71	08.05 - 06.09	G4EE	4		RC-HD1206	44332
1,6	77	09.02 - 09.05	G4HD-G	4		RC-HD1206	44332
1,6	78	08.05 - 06.09	G4HD-G	4		RC-HD1206	44332

H100

2,4	84	08.97 - 10.01	G4CS	4		RC-HD1203	6206
-----	----	---------------	------	---	--	-----------	------

H200

2,4	82	10.97 - 07.03	G4CS	4		RC-HD1203	6206
-----	----	---------------	------	---	--	-----------	------

I10

1,1	49	01.08 -	G4HG	4		RC-KA1204	6299
1,1	51	04.11 -	G4HG	4		RC-KA1204	6299
1,2	57	11.08 -	G4LA	4		RC-HD1302	44327
1,2	63	04.11 -	G4LA	4		RC-HD1302	44327



kW

C
y
l

Stock-No.

HYUNDAI**I20**

1,2	63	09.08 -	G4LA	4		RC-HD1302	44327
-----	----	---------	------	---	--	-----------	-------

I30

2,0	105	10.07 - 11.01	G4GC-G	4		RC-HD407	0709
-----	-----	---------------	--------	---	--	----------	------

Lantra

1,5	62	12.90 - 05.95	G4DJ	4		RC-HD408	0710
1,5	65	02.97 - 05.00	G4EK	4		RC-FT444	0691
1,6	66	02.96 - 10.00	G4GR	4		RC-HD1206	44332
1,6	66	09.95 - 05.00	G4DR	4		RC-HD407	0709
1,6	78	12.90 - 05.95	G4CR	4		RC-HD1201	2570
1,6	84	12.90 - 05.95	G4CR	4		RC-HD409	0711
1,6	84	06.95 - 05.00	G4GR	4		RC-HD407	0709
1,8	93	12.90 - 05.95	G4CN	4		RC-HD1201	2570
1,8	94	06.95 - 05.00	G4GM	4		RC-HD409	0711
2,0	101	04.97 - 05.00	G4DF	4		RC-HD407	0709

Matrix

1,6	66	01.02 - 12.05	G4ED-L	4		RC-HD1206	44332
1,6	76	06.01 - 08.10	G4ED-G	4		RC-HD1206	44332
1,8	90	06.01 -	G4EB	4		RC-HD407	0709

Pony

1,3	43	09.89 - 08.94	G4DG	4		RC-HD408	0710
1,3	48	09.89 - 09.94	G4DG	4		RC-HD408	0710
1,3	50	10.85 - 09.89	G13B	4		RC-HD408	0710
1,3	51	09.89 - 08.94	G4DG	4		RC-HD408	0710
1,3	53	09.89 - 08.94	G15B	4		RC-HD408	0710
1,3	63	09.94 - 12.99	G4EH	4		RC-FT444	0691
1,5	62	09.89 - 09.94	G4DJ	4		RC-HD408	0710
1,5	65	09.94 - 12.99	G4EK	4		RC-FT444	0691

Santa Fé

2,0	99	08.00 - 03.06	G4BPD0HC	4		RC-HD1204	6301
2,4	107	08.00 - 03.06	G4CSD0HC	4		RC-HD1204	6301
2,7	127	08.00 -	G6BA	6		RC-HD1205	6302

Santamo

2,0	77	10.98 - 10.02	G4CP	4		RC-HD1204	6301
2,0 16V	102	10.98 - 10.02		4		RC-HD1201	2570

S-Coupé

1,5	62	03.90 - 08.91	G4DJ	4		RC-HD408	0710
1,5	65	07.92 - 07.93	G4EK	4		RC-HD408	0710
1,5 Turbo	85	04.91 - 04.96	G4EKT	4		RC-HD301	8300
1,5 1500i		01.91 - 12.92	-	4		RC-HD408	0710

Sonata

1,8	72	01.93 - 01.96	G4CN	4		RC-HD411	0713
2,0	77	10.88 - 06.96	G4CP	4		RC-HD411	0713
2,0	92	06.96 - 06.98	G4JCPDM	4		RC-HD1201	2570
2,0	96	06.01 - 11.04	G4JPE	4		RC-HD1204	6301
2,0	100	06.98 - 05.01	G4JPE	4		RC-HD1204	6301
2,0	102	01.91 - 01.98	G4CP	4		RC-HD409	0711
2,5	118	06.98 - 05.01	G6DV	6		RC-HD1205	6302
2,7	127	06.01 - 11.04	G6BAJ	6		RC-HD1205	6302
3,0	107	09.90 - 06.93	G6AT	6		RC-HD404	0706

H1 / Starex

2,4	82	10.97 - 04.04	G4CS	4		RC-HD1203	6206
2,4	99	11.01 - 04.04	G4JS	4		RC-HD1204	6301
2,4	107	11.01 - 04.04	G4JS	4		RC-HD1204	6301



kW

C
y
l

Stock-No.

HYUNDAI**Trajet**

2,0	102	09.99 - 10.03	G4CPDOHC	4		RC-HD1204	6301
2,0	100	03.00 - 02.04	G4JP-G	4		RC-HD1204	6301
2,0	100	02.04 - 07.08	G4JP-G	4		RC-HD407	0709
2,0	103	02.04 - 07.08	G4GC-G	4		RC-HD407	0709
2,7	127	02.00 -	G6BAJ	6		RC-HD1205	6302

Tucson

2,0	104	06.04 -	G6GC	4		RC-HD407	0709
2,7	129	06.04 -	G6BAH	6		RC-HD1205	6302

XG25

2,5	120	06.99 -	G6AV	6	>11.02	RC-HD1205	6302
-----	-----	---------	------	---	--------	-----------	------

INNOCENTI**90**

1,0	31	03.82 - 02.86	99H	4		RC-AT405	0543
1,0	49	04.74 - 02.86	99H	4		RC-AT405	0543

120

1,3	43	04.74 - 02.86	12H	4		RC-AT405	0543
1,3	64	03.78 - 02.86	12H	4		RC-AT405	0543

Mille

1,0	49	04.74 - 06.83	99H	4		RC-AT405	0543
1,3	43	11.75 - 12.83	12H	4		RC-AT405	0543

Mini

1,3	47	09.76 - 10.83	BLMC12H	4		RC-AT405	0543
1,3 Cooper	51	09.76 - 10.83	BLMC12HH	4		RC-AT405	0543

Tomaso

1,0 Turbo	40	01.78 - 04.84	99S	4		RC-AT405	0543
1,3	53	04.74 - 02.86	12H	4		RC-AT405	0543

ISUZU (GM)**Campo**

2,0	58	06.85 - 03.88	G200Z	4		RC-IE42	9248
2,3	65	04.88 - 08.90	4ZD1	4		RC-FD825	8569

Trooper

2,3	66	09.84 - 09.91	4ZD1	4		RC-FD825	8569
2,6	66	11.86 - 07.91	4ZE1	4		RC-FD825	8569
2,6	85	11.86 - 07.91	4ZE1	4		RC-FD825	8569

JAGUAR**Sovereign**

3,4	119	10.79 - 09.85	8A	6		RC-JG1205	2475
4,2	132	10.85 - 09.86	8LR	6		RC-JG1205	2475
4,2	151	10.79 - 09.85	8LR	6		RC-JG1205	2475

XJ12

5,3	194	10.85 - 09.92	7P2	12		RC-JG1203	7703
5,3	198	06.71 - 05.75	7P1	12		RC-JG1202	5409
5,3	217	10.85 - 04.91	7P	12		RC-JG1203	7703
6,0	229	09.94 - 09.97	8C	12		RC-JG1203	7703



kW

C
y
l

Stock-No.

JAGUAR**XJ6**

2,9	108	10.88 - 08.90	9A	6		RC-JG1204	2581
2,9	117	10.87 - 09.88	9A	6		RC-JG1204	2581
2,9	123	10.86 - 09.90	9A	6		RC-JG1204	2581
3,2	146	10.90 - 08.94	9H	6		RC-JG1201	5406
3,2	155	09.94 - 09.97	9H	6		RC-JG1201	5406
3,6	136	10.86 - 09.87	9D	6		RC-JG1201	5406
3,6	145	10.87 - 09.89	9D	6		RC-JG1201	5406
3,6	162	10.86 - 09.89	9D	6		RC-JG1201	5406
4,0	163	10.89 - 08.94	9E	6		RC-JG1201	5406
4,0	177	09.94 - 09.97	9J	6		RC-JG1201	5406
4,0	187	10.89 - 08.94	9E	6		RC-JG1201	5406

XJS

3,6	136	10.87 - 02.91	9D	6		RC-JG1201	5406
3,6	146	10.87 - 02.91	9D	6		RC-JG1201	5406
3,6	156	05.84 - 09.87	9D	6		RC-JG1201	5406
4,0	163	09.92 - 08.94	AJ60100	6		RC-JG1201	5406
4,0	171	09.94 - 10.96	AJ60100	6		RC-JG1201	5406
5,3	197	05.84 - 09.87	8P	12		RC-JG1203	7703
5,3	211	10.87 - 02.91	8E	12		RC-JG1203	7703
5,3	213	10.74 - 07.81	8S	12		RC-JG1203	7703
5,3	217	10.74 - 09.87	8S	12		RC-JG1203	7703
5,3	217	05.84 - 09.87	8P	12		RC-JG1203	7703

JEEP (CHRYSLER)**Cherokee**

2,5	81	10.83 - 09.86	U150	4		RC-GM1202	5557
2,5	87	10.96 - 09.99	EPE	4		RC-CR310	8294
2,5	89	10.90 - 09.96	EPE	4		RC-CR310	8294
2,5	90	10.86 - 09.90	EPE	4		RC-GM1202	5557
2,5	130	01.89 -	-	4		RC-GM1202	5557
4,0	131	10.96 - 09.01	ERH	6		RC-CR302	8284
4,0	135	10.90 - 09.96	ERH	6		RC-CR302	8284

CJ7

2,5	87	10.83 - 09.86	Y150	4		RC-GM1202	5557
-----	----	---------------	------	---	--	-----------	------

CJ8

2,5	87	10.83 - 09.86	Y150	4		RC-GM1202	5557
-----	----	---------------	------	---	--	-----------	------

Comanche

2,5	90	10.86 - 09.90	EPE	4		RC-GM1202	5557
-----	----	---------------	-----	---	--	-----------	------

Grand Cherokee

4,0	131	10.96 - 09.98	ERH	6		RC-CR302	8284
4,0	135	10.90 - 09.96	ERH	6		RC-CR302	8284
5,2	156	10.90 - 09.96	EHY	8		RC-CR306	8288

Wagoneer

2,5	87	10.83 - 09.86	Y246	4		RC-GM1202	5557
-----	----	---------------	------	---	--	-----------	------

Wrangler

2,5	76	10.87 - 10.92		4		RC-GM1202	5557
2,5	87	10.96 - 09.02	EPE	4		RC-CR301	8283
2,5	89	10.90 - 09.96	EPE	4		RC-CR310	8294
4,0	130	12.91 - 09.06		4		RC-CR302	8284

KIA**Avtotor**

2,5	124	03.01 - 09.05	201B	6		RC-HD1205	6302
-----	-----	---------------	------	---	--	-----------	------



kW

C
y
l

Stock-No.

KIA**Carens**

1,6	77	07.02 - 12.06	K0CB5	4		RC-KA1203	6209
1,8	81	07.99 - 06.02	OK2CN	4	Semi-Direct	RC-KA1201	4066
1,8	93	04.02 - 08.06	T8D	4	Semi-Direct	RC-KA1201	4066
2,0	102	08.04 -	G4GC	4		RC-KA407	0709

Carnival

2,5	110	01.02 - 08.05	OK52	6		RC-KA1206	6348
3,5	143	12.02 -	G6JY	6	Semi-Direct	RC-ME95	5074

Cee'd

2,0	105	12.06 -	G4GC	4		RC-HD407	0709
-----	-----	---------	------	---	--	----------	------

Cerato

1,6	77	07.04 -	G4ED	4		RC-HD1206	44332
2,0	105	04.04 -	G4EC	4		RC-HD407	0709

Clarus

1,8	85	02.96 - 08.01	OK9B0	4	Semi-Direct	RC-KA1201	4066
1,8	85	02.96 - 08.01	OK9BB	4	Semi-Direct	RC-KA1201	4066
2,0	98	03.96 - 10.00	OK9BD	4		RC-ZX15	9916
2,0	98	03.96 - 08.01	OK9BC	4		RC-ZX15	9916
2,0	98	07.96 -	FE	4		RC-ZX15	9916
2,0	98	03.99 - 10.00	OK9BC	4		RC-KA1205	6306
2,0	98	03.99 - 10.00	OK9BD	4		RC-KA1205	6306

Credos

1,8	85	06.96 - 11.98	OK9B0	4	Semi-Direct	RC-KA1201	4066
1,8	85	06.96 - 11.98	OK9BB	4	Semi-Direct	RC-KA1201	4066
2,0	98	03.96 - 10.00	OK9BC	4		RC-ZX15	9916
2,0	98	03.96 - 10.00	OK9BD	4		RC-ZX15	9916

Joice

2,0	88	01.01 - 09.03	4G63DOHC	4		RC-HD1201	2570
2,0	102	05.99 - 05.03	4G63DOHC	4		RC-HD1201	2570

Magentis

2,0	100	03.01 - 09.05	201A	4	Semi-Direct	RC-HD1204	6301
2,0	106	11.05 -	G4KA	4	Semi-Direct	RC-HD1204	6301
2,5	124	03.01 -	201B	6		RC-HD1205	6302

Mentor

1,5	59	06.94 - 05.01	OK282	4		RC-KA401	0714
1,5	65	05.99 - 03.01	OK2AC	4	Semi-Direct	RC-KA1201	4066
1,6	60	05.94 - 05.96	OK20N	4		RC-KA401	0714
1,6	60	05.94 - 05.96	OK20R	4		RC-KA401	0714

Morning

1,0	45	03.04 -	G4FG	4		RC-KA1204	6299
-----	----	---------	------	---	--	-----------	------

Picanto

1,0	45	03.04 - 04.11	G4HE	4		RC-KA1204	6299
1,0	46	10.07 - 04.11	G4HE	4		RC-KA1204	6299
1,1	48	03.04 -	G4HG	4		RC-KA1204	6299

Pride

1,1	40	05.91 - 04.94	B116	4		RC-KA402	0715
1,3	44	05.91 - 04.94	B3A6	4		RC-KA402	0715
1,3	47	06.97 - 05.01	KK11C	4		RC-KA402	0715
1,3	47	06.97 - 05.01	KK11D	4		RC-KA402	0715
1,3	48	05.94 - 05.97	MB376	4		RC-KA402	0715
1,3	51	06.91 - 09.92	B3A7	4		RC-KA402	0715
1,3	54	05.94 - 05.97	MB376	4		RC-KA402	0715



kW

C
y
I

Stock-No.

KIA**Retona**

2,0	94	10.99 - 10.01	3FE	4		RC-KA404	0717
-----	----	---------------	-----	---	--	----------	------

Rio

1,3	55	07.00 - 07.02	KOAB7	4		RC-KA1202	4077
1,3	55	08.01 - 07.02	KZK0AB7	4		RC-KA1202	4077
1,3	60	08.02 -	KZ301	4		RC-KA1202	4077
1,4	71	03.05 -	G4EE	4		RC-HD1206	44332
1,5	72	06.01 - 07.02	KZ263	4		RC-KA1203	6209
1,5	72	08.02 - 02.05	KZ306	4		RC-KA1203	6209
1,6	82	03.05 -	G4ED	4		RC-HD1206	44332

Sedona

2,5	110	01.02 - 11.05	OK52	6		RC-KA1206	6348
-----	-----	---------------	------	---	--	-----------	------

Sephia

1,5	59	03.96 - 12.98	OK282	4		RC-KA401	0714
1,5	59	03.96 - 12.98	OK280	4		RC-KA401	0714
1,6	60	05.93 - 02.96	OK20N	4		RC-KA401	0714
1,6	60	08.94 - 02.96	OK20R	4		RC-KA401	0714
1,8	82	01.95 -	OK20N	4	Semi-Direct	RC-KA1201	4066

Shuma

1,5	65	02.98 - 03.01	OK2AD	4	Semi-Direct	RC-KA1201	4066
1,5	65	02.98 - 03.01	OK2AC	4	Semi-Direct	RC-KA1201	4066
1,6	75	04.01 - 06.05	B4ZE	4		RC-KA1203	6209
1,8	84	08.01 - 06.05	T8D	4	Semi-Direct	RC-KA1201	4066

Sorento

2,4	102	07.02 - 08.06	G4NS	4	Semi-Direct	RC-HD1204	6301
3,5	143	07.02 -	G6JY	6	Semi-Direct	RC-ME95	5074

Sportage

2,0	87	10.00 - 12.02	FE88	4	Semi-Direct	RC-KA404	0717
2,0	94	08.94 - 04.99	OK01R	4	Semi-Direct	RC-KA404	0717
2,0	104	09.04 -	G4GC	4		RC-HD407	0709
2,7	129	07.04 -	G6BA	6		RC-HD1205	6302

LADA (AVTOVAZ)**LADA (AvtoVAZ) various**

1200 1,2	44	01.70 - 09.86	BA32101	4		RC-ST405	0906
1300 1,3	51	10.74 - 10.79	BA32105	4		RC-ST405	0906
1300 1,3	49	11.79 - 09.86	BA32105	4		RC-ST405	0906
1500 1,5	55	10.72 - 09.86	BA32103	4		RC-ST405	0906
1600 1,6	58	11.78 - 09.86	BA32106	4		RC-ST405	0906
110 (VAZ2110) 1,5	52	06.96 -	211114	4		RC-LD1201	4943
110 (VAZ2110) 1,5	56	10.00 - 09.04	2111	4		RC-LD1203	4054
110 (VAZ2110) 1,5	67	06.96 -	211210	4		RC-LD1201	4943
110 (VAZ2110) 1,5	67	02.01 -	211210	4		RC-LD1202	4944
111 (VAZ2111) 1,5	58	-	211210	4		RC-LD1201	4943
111 (VAZ2111) 1,5	67	11.96 -	211210	4		RC-LD1201	4943
111 (VAZ2111) 1,5	67	02.01 -	211210	4		RC-LD1202	4944
112 (VAZ2112) 1,5	56	10.00 - 09.04	2111	4		RC-LD1203	4054
112 (VAZ2112) 1,5	67	02.01 -	211210	4		RC-LD1202	4944

Forma (Samara)

1,3	48	06.90 - 10.92	B22108	4		RC-LD301	7068
1,3	48	03.92 - 05.95	B32108	4		RC-LD301	7068
1,5	51	06.95 - 12.99	B321093	4		RC-LD302	7104
1,5	53	06.90 - 10.92	B221083	4		RC-LD302	7104
1,5	53	03.92 - 05.95	B321083	4		RC-LD302	7104



kW

C
y
l

Stock-No.

LADA (AVTOVAZ)**Forma (Samara)**

1,5	57	01.00 -	VAZ-2111	4		RC-LD1203	4054
1,5	59	08.03 -	VAZ-2111	4		RC-LD1203	4054

Niva

1,6	55	10.76 - 01.92	BA33	4		RC-LD302	7104
1,6	57	11.91 - 10.94	BA38	4		RC-LD302	7104
1,7	57	09.02 -		4		RC-LD1201	4943
1,7	59	11.94 - 09.00	B05C	4		RC-LD1205	6019
1,7	59	11.94 - 09.00	BA3 21214	4		RC-FT431	0678
1,7	59	11.94 - 08.02	BA5C	4		RC-LD1205	6019

Nova

1,3	49	09.81 - 09.86	BA32105	4		RC-ST405	0906
-----	----	---------------	---------	---	--	----------	------

Samara

1,1	39	07.87 - 05.95	B321081	4		RC-LD301	7068
1,1	39	07.87 - 10.92	B221081	4		RC-LD301	7068
1,3	48	05.86 - 10.92	B22108	4		RC-LD301	7068
1,3	48	05.86 - 05.95	B32108	4		RC-LD301	7068
1,5	51	06.95 - 12.99	B321093	4		RC-LD301	7068
1,5	51	02.97 - 12.00	B321093	4		RC-LD1203	4054
1,5	53	05.86 - 05.95	B321083	4		RC-LD301	7068
1,5	53	07.87 - 10.92	B221083	4		RC-LD301	7068

LADA (AVTOVAZ) / RUSSIA**LADA (AvtoVAZ) / RUSSIA various**

110 1,5 21100	52	-	BA32109	4		RC-LD301	7068
110 1,5 21102i	57	01.96 -	BA32111	4		RC-LD1201	4943
110 1,5 21103 16V	67	01.96 -	BA32112	4		RC-LD1202	4944
110 1,5 21108/21109 16V		-	BA32112	4		RC-LD1202	4944
111 1,5 21111	52	01.98 -	BA32110	4		RC-LD301	7068
111 1,5 21110i	57	01.98 -	BA32111	4		RC-LD1201	4943
111 1,5	58	10.00 - 01.01	2111	4		RC-LD1202	4944
111 1,5	58	02.01 - 09.04	2111	4		RC-LD1203	4054
111 1,5 21113 16V	67	01.98 -	BA32112	4		RC-LD1202	4944
112 1,5	56	10.00 - 09.04	2111	4		RC-LD1203	4054
112 1,5 21122i	57	01.00 -	VAZ2111	4		RC-LD1201	4943
112 1,5 21120 16V	67	01.00 -	VAZ2112	4		RC-LD1202	4944
2106 1,6	55	-	BA32106	4		RC-LD302	7104
21050 1,3	47	01.88 -	BA321011	4		RC-LD302	7104
21051 1,2	43	01.80 - 12.88	BA32101	4		RC-LD302	7104
21053 1,5	52	-	BA32103	4		RC-LD302	7104
21060 1,3	47	-	BA321011	4		RC-LD302	7104
21063 1,5	52	-	BA32103	4		RC-LD302	7104
21070 1,3	47	01.82 -	BA321011	4		RC-LD302	7104
21073 1,5	53	01.88 -	BA32103	4		RC-LD302	7104
2101/21011/21012/21013/ 21014 1,2	43	-	BA32101	4		RC-LD302	7104
2101/21011/21012/21013/ 21014 1,3	47	-	BA321011	4		RC-LD302	7104
2102/21021/21022/21023/ /21024/21026 1,2	43	-	BA32101	4		RC-LD302	7104
2102/21021/21022/21023/ 21024/21026 1,3	47	-	BA321011	4		RC-LD302	7104
2103/21033/21035 1,3	47	-	BA321011	4		RC-LD302	7104
2103/21033/21035 1,5	52	-	BA32103	4		RC-LD302	7104
21073-40 1,7	59	-	BA321073	4		RC-LD302	7104



kW

C
y
i

Stock-No.

LADA (AVTOVAZ) / RUSSIA**Nadeschda**

1,7 2120i	60	01.98 -	BA321214	4		RC-FT431	0678
1,8 2120	59	01.98 -	BA32130	4		RC-FT431	0678

Niva

1,6 21210	51	01.77 -	BA32121	4		RC-FT431	0678
1,7 2346	59	-	BA321213	4		RC-FT431	0678
1,7 2131	59	-	BA32130	4		RC-LD302	7104
1,7 21310i	60	01.95 -	BA321214	4		RC-FT431	0678
1,7 21214i	60	01.01 -	BA321214	4		RC-LD1205	6019
1,7		-	BA22213	4		RC-LD1204	9176

Novo

1,2 21051	44	01.81 - 12.88	VAZ21051	4		RC-LD302	7104
1,2 2105 Junior		-	-	4		RC-LD302	7104
1,3 21040	47	01.84 - 12.88	BA321011	4		RC-LD302	7104
1,3 2102/2105	48	01.81 - 12.88	VAZ2102;2105	4		RC-LD302	7104
1,3 2105		-	-	4		RC-LD302	7104
1,5 21043 Hatchback	53	01.88 -	BA32102	4		RC-LD302	7104
1,5 21043	55	01.88 -	VAZ21043	4		RC-LD302	7104
1,5 2105 Spezial		-	-	4		RC-LD302	7104
1,7	59	01.94 -	-	4		RC-LD302	7104
1,7 21044-40 Hatchback	59	-	BA321073	4		RC-LD302	7104
1,7	62	01.94 -	-	4		RC-LD302	7104
2104/2105	55	01.86 - 01.88	VAZ2104;2105	4		RC-LD302	7104
2107	57	01.81 - 12.88	VAZ2107	4		RC-LD302	7104
2107	57	01.88 -	VAZ2104	4		RC-LD302	7104

Riva

1,2 1200	47	01.85 -	OHC21012	4		RC-LD302	7104
1,3 1300	49	01.85 -	OHC21056	4		RC-LD302	7104
1,5 1500	55	01.85 -	OHC21026	4		RC-LD302	7104
1,6 1600	63	01.86 -	OHC21062	4		RC-LD302	7104

Samara

1,1 21081 Fun 1100	39	01.84 -	-	4		RC-LD301	7068
1,1 21091	39	01.87 -	-	4		RC-LD301	7068
1,3 21080 Fun 1300	47	-	BA32108	4		RC-LD301	7068
1,3 21090	48	01.87 -	BA32108	4		RC-LD301	7068
1,3 21099	48	01.90 -	BA32108	4		RC-LD301	7068
1,5 2115	49	-	BA321083	4		RC-LD301	7068
1,5 210993i	52	-	BA32111	4		RC-LD1201	4943
1,5 21093	52	-	BA321083	4		RC-LD301	7068
1,5 21083 Fun 1500	53	01.84 -	BA32103	4		RC-LD301	7068
1,5 21093	53	01.87 -	BA32103	4		RC-LD301	7068
1,5 2115i	57	01.00 -	BA32111	4		RC-LD1201	4943
1,5 2114i	57	01.01 -	BA32111	4		RC-LD1201	4943
1,5 21083i	57	-	BA32111	4		RC-LD1201	4943

Toscana

1,5	55	01.86 -	-	4		RC-LD302	7104
1,5 2107	55	01.88 -	-	4		RC-LD302	7104

LANCIA**A112**

0,9	29	09.79 - 08.85	A112B2000	4		RC-LC403	0722
0,9	32	09.79 - 08.85	A112A5000	4		RC-LC617	7286
1,0	35	07.76 - 08.85	A112B1000	4		RC-LC403	0722



kW

C
y
l

Stock-No.

LANCIA**A112**

1,1	52	10.73 - 08.85	A112A2000	4		RC-LC403	0722
-----	----	---------------	-----------	---	--	----------	------

Beta

2,0	85	03.76 - 10.84	828B1000	4		RC-LC1205	5590
2,0	88	05.76 - 05.78	828B1000	4		RC-LC1205	5590
2,0	88	08.81 - 10.85	828B2000	4		RC-LC1205	5590
2,0	90	02.77 - 10.83	828B1000	4		RC-LC1205	5590
2,0	90	06.78 - 06.85	828B2000	4		RC-LC1205	5590
2,0	99	10.82 - 12.86	828B7000	4		RC-LC1205	5590
2,0	99	08.83 - 09.84	828B2000	4		RC-LC1205	5590

Dedra

1,6	55	09.91 - 06.94	835C1000	4		RC-FT203	0645
1,6	57	09.89 - 06.94	835A1046	4		RC-LC604	8220
1,6	66	09.89 - 06.94	835A1000	4		RC-LC604	8220
1,6	66	07.94 - 08.97	159B9000	4		RC-FT203	0645
1,6	76	02.97 - 10.99	182A4000	4		RC-FT1202	2571
1,8	66	09.91 - 06.94	835C5000	4		RC-FT605	8206
1,8	74	07.94 - 08.97	836A5000	4		RC-FT605	8206
1,8	77	09.89 - 06.94	835A2046	4		RC-FT605	8206
1,8	80	09.89 - 06.94	835A2046	4		RC-FT605	8206
1,8	83	07.94 - 10.98	182A2000	4		RC-LC618	7287
2,0	83	09.89 - 09.94	835A5046	4		RC-FT605	8206
2,0	83	10.94 - 08.97	835A5046	4		RC-LC1102	44242
2,0	103	07.94 - 08.98	836A3000	4		RC-FT603	8202
2,0 Turbo	119	04.90 - 06.94	835A8046	4		RC-FT605	8206
2,0 Turbo	124	04.90 - 06.94	835A7046	4		RC-FT605	8206

Delta

1,1	47	08.85 - 10.90	831B8000	4		RC-LC609	8524
1,3	57	08.85 - 04.91	831B000	4		RC-FT624	3666
1,5	60	11.90 - 10.93	831B1000	4		RC-LC610	8528
1,5	63	10.81 - 07.85	831A1000	4		RC-LC610	8528
1,6	55	11.93 - 08.96	835C1000	4		RC-FT203	0645
1,6 GT iE	66	08.85 - 10.93	149C2000	4		RC-LC611	8529
1,6	66	05.95 - 05.00	182A6000	4		RC-FT1202	2571
1,6	76	05.95 - 05.00	182A4000	4		RC-FT203	0645
1,6 GT iE	80	08.86 - 10.88	831B7000	4		RC-ST403	0904
1,6 Turbo	97	03.88 - 10.93	831B7046	4		RC-ST403	0904
1,6 GT iE	101	08.85 - 04.91	831B7000	4		RC-ST403	0904
1,6 Turbo	103	08.85 - 10.90	831B3000	4		RC-ST403	0904
1,8	66	11.94 - 08.96	835C4000	4		RC-LC618	7287
1,8	76	11.93 - 08.96	835C2000	4		RC-LC618	7287
1,8	83	05.95 - 04.98	182A2000	4		RC-LC618	7287
1,8	97	05.95 - 05.00	183A1000	4		RC-LC614	7206
1,8 GT iE	97	02.96 - 09.97	183A1000	4		RC-LC614	7206
2,0	102	11.93 - 05.00	836A3000	4		RC-FT603	8202
2,0 GT iE	102	02.96 - 05.00	836A3000	4		RC-FT603	8202
2,0 GT iE	108	11.94 - 04.98	836A3000	4		RC-FT603	8202
2,0 Turbo	130	05.87 - 10.94	831C5046	4		RC-LC611	8529
2,0 Turbo	137	07.91 - 10.94	836A2000	4		RC-LC612	8530
2,0 Turbo	155	07.91 - 10.94	831E5046	4		RC-LC612	8530
2,0 Turbo	158	11.89 - 10.94	831E5000	4		RC-LC612	8530

Kappa

2,0	151	02.95 - 10.01	838AB1AA	4		RC-LC201	0663
-----	-----	---------------	----------	---	--	----------	------

Lybra

1,6	76	07.99 - 09.00	182A4000	4		RC-FT1202	2571
1,6	76	10.00 - 10.05	186B6000	4		RC-FT1202	2571



kW

C
y
I

Stock-No.

LANCIA**Musa**

1,4	57	09.05 -	350A1.000	4		RC-FT1209	4746
1,4	70	10.04 -	843A1000	4		RC-FT1209	4746

Prisma

1,3	55	09.79 - 10.82	831A100	4		RC-AR406	0530
1,5	55	08.85 - 02.88	138C000	4		RC-LC406	0725
1,5	63	09.79 - 02.88	831B1000	4		RC-AR406	0530
1,6	66	08.85 - 07.90	149C2000	4		RC-VX402	0973
1,6	73	05.86 - 07.89	831B6000	4		RC-LC606	8222
1,6	77	11.82 - 10.85	831A4000	4		RC-LC606	8222
1,6	79	08.85 - 07.90	831B7000	4		RC-VX402	0973
2,0	85	04.86 - 12.89	831B4000	4		RC-VX402	0973

Thema

2,0	83	06.87 - 10.89	834B048	4		RC-LC606	8222
2,0	83	11.89 - 09.94	834B146	4		RC-LC606	8222
2,0	88	09.84 - 05.87	834B000	4		RC-LC606	8222
2,0	88	06.87 - 10.89	834B1000	4		RC-LC606	8222
2,0	108	04.89 - 09.92	834B2000	4		RC-FT618	8248
2,0 Turbo	110	10.85 - 10.90	834C146	4		RC-LC606	8222
2,0 Turbo	110	06.87 - 02.92	834C146	4		RC-FT618	8248
2,0 Turbo	122	09.84 - 10.89	834C000	4		RC-LC1201	5408
2,0 Turbo	133	04.89 - 09.92	834C1000	4		RC-FT618	8248
2,0 Turbo	147	01.91 - 05.95	834F2000	4		RC-LC1101	44231
2,8	108	03.88 - 10.92	834E146	6		RC-LC1203	2589
2,8	110	10.84 - 10.92	834A000	6		RC-LC1202	2588
3,0	128	11.92 - 09.94	834F000	6		RC-LC901	8575

Y (Ypsilon)

1,1	40	09.95 - 05.97	176B2000	4		RC-FT601	8192
1,2	44	08.00 - 09.03	188A4000	4		RC-FT201	0643
1,2	59	08.00 - 09.03	188A5000	4		RC-FT1203	2995
1,2	63	10.96 - 07.00	176B9000	4		RC-FT632	7209
1,4	55	09.95 - 02.98	840A4000	4		RC-FT201	0643
1,4	59	09.95 - 02.98	840A2000	4		RC-FT201	0643

Y10 (Ypsilon)

1,0	32	05.86 - 06.89	156A2100	4		RC-FT621	8523
1,0	33	04.87 - 08.95	156A2000	4		RC-LC615	7207
1,0	33	04.87 - 08.95	156A2246	4		RC-FT621	8523
1,0 Turbo	62	05.85 - 06.89	156A1000	4		RC-LC607	8502
1,1	37	07.89 - 09.92	156C046	4		RC-FT621	8523
1,1	37	10.92 - 08.95	156C046	4		RC-LC1301	2997
1,1	40	01.95 - 12.95	156C000	4		RC-LC1301	2997
1,3 GT iE	57	10.87 - 09.92	156B000	4		RC-LC616	7208

Ypsilon

1,2	44	10.03 - 12.11	188A4000	4		RC-FT1208	9262
1,2	51	08.10 - 12.11	169A5000B	4		RC-FT1209	4746
1,2	51	05.11 -	169A4000	4		RC-FT1209	4746
1,4	57	02.06 -	350A1000	4		RC-FT1209	4746

Z(eta)

2,0 Turbo	108	08.94 - 12.99	RGX	4		RC-CR602	8480
-----------	-----	---------------	-----	---	--	----------	------

LANDROVER**88**

2,3	52	11.71 - 05.81	11H	4		RC-RV406	0881
-----	----	---------------	-----	---	--	----------	------



kW

C
y
l

Stock-No.

LANDROVER**Defender 110**

3,9	136	11.98 -	31G	8		RC-RV323	7079
-----	-----	---------	-----	---	--	----------	------

Discovery

2,0	100	10.93 - 12.98	20T4HG	4		RC-RV315	8299
3,5	114	10.89 - 06.94	22D	8		RC-RV309	8279
3,5	122	10.89 - 06.94	22D	8		RC-RV309	8279
4,5	134	07.94 - 12.98	35L	8		RC-RV309	8279
4,5	136	01.99 - 10.02	56D	8		RC-RV309	8279

Freelander

1,8	86	10.00 - 09.03	18K16HOU	4	Semi-Direct	RC-RV1202	7705
1,8	88	07.97 - 09.00	18K16	4		RC-RV1201	2585
1,8	88	09.98 - 09.00	18K4F	4		RC-RV1202	7705
2,5	129	10.00 - 09.03	25K4F		Semi-Direct	RC-RV901	7408

Range Rover

3,5	93	08.81 - 09.90	11D	8		RC-RV309	8279
3,5	120	10.85 - 09.89	23G	8		RC-RV309	8279
4,2	149	09.91 - 04.94	40D	8		RC-RV1207	2577
4,2	127	10.89 - 04.94	37D	8		RC-RV309	8279
4,2	127	10.89 - 04.94	38D	8		RC-RV309	8279
4,2	134	10.89 - 09.95	36D	8		RC-RV309	8279
4,2	134	09.91 - 09.95	35D	8		RC-RV309	8279
4,2	136	10.89 - 08.91	35D	8		RC-RV309	8279
4,6	140	05.94 - 04.96	42D	8		RC-RV323	7079
4,6	165	05.94 - 10.98	46D	8	>Chassis No WA410481	RC-RV323	7079
4,6	165	05.94 - 10.98	46D	8	Chassis No XA410482>	RC-RV322	7078

LDV INTERNATIONAL**Sherpa**

1,6 KB16	48	03.74 - 09.78	KB16	4		RC-RN1201	6981
1,7 KB17	54	10.78 - 12.82	KB17	4		RC-MX1201	7702
2,0 G20A	64	01.83 - 09.88	G20A	4		RC-MX1201	7702
2,0	64	04.85 - 03.89	20V	4		RC-MX1201	7702

LEXUS**GS 300**

3,0	156	03.93 - 08.97	2JZGE	6		RC-TE120	2816
3,0	161	09.00 -	2JZGE	6		RC-TE120	2816
3,0	163	09.97 - 08.00	2JZGE	6		RC-TE120	2816

LS 400

4,5	180	12.89 - 09.94	1UZFE	8		RC-TE132	3075
4,5	194	10.94 - 09.97	1UZFE	8		RC-TE132	3075
4,5	203	10.98 - 07.00	1UZFE	8		RC-TE132	3075
4,5	209	10.97 - 09.98	1UZFE	8		RC-TE132	3075
4,5	216	10.97 - 07.00	1UZFE	8		RC-TE132	3075

LOTUS**Elise**

1,8	88	08.95 - 08.00	18K4F	4		RC-RV415	0890
1,8	107	08.95 - 08.00	18K4K	4		RC-RV1203	7707
1,8	116	09.00 -	18K4FN03	4	Semi-Direct	RC-RV1202	7705

Esprit

2,2 Turbo	157	10.81 - 09.87	910	4		RC-FD825	8569
2,2 Turbo	160	10.87 - 10.91	910	4		RC-FD825	8569
2,2 Turbo	197	06.89 - 10.93	910	4		RC-FD825	8569



kW

C
y
l

Stock-No.

LEXUS**Excel**

2,2	118	09.86 - 12.89	GA22S	4		RC-FD825	8569
2,2	135	10.84 - 08.91	GA22E	4		RC-FD825	8569

MAZDA**121**

1,1	40	03.88 - 07.93	B116	4		RC-ZE08	9848
1,2	55	03.96 - 12.03	DHG	4		RC-FD548	0642
1,3	37	01.96 - 10.02	1E02	4		RC-FD544	0639
1,3	37	09.98 - 10.02	1E02	4		RC-FD1205	2584
1,3 16V	40	11.90 - 03.96	B3	4		RC-ZE23	9857
1,3	44	03.96 - 12.03	J4R	4		RC-FD544	0639
1,3	44	03.96 - 12.03	J4R	4		RC-FD1205	2584
1,3	54	11.90 - 12.95	B3C9	4		RC-EZ1211	6365

2

1,2	55	02.03 -	FUJA	4		RC-FD807	8541
1,3	67	04.03 -	ZJ04	4		RC-FD807	8541
1,4	59	02.03 -	FXJA	4		RC-FD807	8541
1,6	74	02.03 -	FYDD	4		RC-FD807	8541

323

1,0	33	02.76 - 07.80	8416	4		RC-NE64	8517
1,1	40	08.80 - 07.82	E101	4		RC-ZE98	9907
1,3	44	02.76 - 07.80	8418	4		RC-NE64	8517
1,3	44	02.76 - 07.80	8420	4		RC-NE64	8517
1,3	44	09.87 - 05.89	E357	4		RC-ZE08	9848
1,3	47	04.87 - 05.89	B335	4		RC-ZE08	9848
1,3	49	09.89 - 07.94	B3E	4		RC-ZX19	9922
1,3	49	09.89 - 07.94	B335	4		RC-ZE08	9848
1,3	49	06.89 - 06.91	B383	4		RC-ZE63	5388
1,3	49	06.89 - 06.91	B315	4		RC-ZX19	9922
1,3	50	08.80 - 07.82	E303	4		RC-ZE98	9907
1,3	50	08.80 - 07.82	E318	4		RC-ZE98	9907
1,3	50	08.80 - 07.82	E319	4		RC-ZE98	9907
1,3	50	08.80 - 07.82	E322	4		RC-ZE98	9907
1,3	50	08.82 - 04.85	E332	4		RC-ZE98	9907
1,3	50	06.89 - 03.91	B383	4		RC-ZX19	9922
1,3	55	06.89 - 06.93	B384	4		RC-ZX19	9922
1,3	55	04.91 - 04.94	B3F4	4		RC-ZX19	9922
1,3	55	05.94 - 10.96	B3P7	4		RC-EZ1210	5903
1,3	55	11.96 - 04.98	B32A	4		RC-EZ1210	5903
1,4	54	08.98 - 09.00	B33G	4		RC-ZE23	9857
1,5	52	10.81 - 07.86	D506	4		RC-ZE98	9907
1,5	55	08.80 - 07.82	E513	4		RC-ZE98	9907
1,5	55	08.80 - 07.82	E517	4		RC-ZE98	9907
1,5	55	08.80 - 07.82	E534	4		RC-ZE98	9907
1,5	55	08.80 - 07.82	E535	4		RC-ZE98	9907
1,5	55	04.87 - 05.89	B506	4		RC-ZE08	9848
1,5	55	04.87 - 05.89	B535	4		RC-ZE08	9848
1,5	55	04.87 - 05.89	B505	4		RC-ZE08	9848
1,5	59	08.82 - 04.85	E597	4		RC-ZE98	9907
1,6	62	06.89 - 03.91	B61A	4		RC-ZX19	9922
1,6	62	06.89 - 03.91	B61B	4		RC-ZX19	9922
1,6	63	01.86 - 10.95	B682	4		RC-ZE08	9848
1,6	63	01.86 - 10.95	B689	4		RC-ZE08	9848
1,6	63	04.87 - 05.89	B6J5	4		RC-ZE08	9848
1,6	63	04.87 - 05.89	B6J6	4		RC-ZE08	9848
1,6	63	07.87 - 08.89	B6J5	4		RC-ZE08	9848



kW

C
y
l

Stock-No.

MAZDA**323**

1,6	63	09.89 - 10.95	B65M	4		RC-ZE08	9848
1,6	64	06.89 - 06.90	B61V	4		RC-ZX19	9922
1,6	66	04.91 - 06.93	B67N	4		RC-ZX19	9922
1,6	66	04.91 - 04.94	B67K	4		RC-ZX19	9922
1,6	66	04.91 - 04.94	B67L	4		RC-ZX19	9922
1,6	77	08.85 - 12.88	B6	4		RC-EZ1214	44271
1,6	100	06.86 - 03.87	B595	4		RC-ZX18	9920
1,6 Turbo GTX	103	04.87 - 05.89	B6D3	4		RC-ZE07	9846
1,6 16V		11.85 - 12.89	-	4		RC-ZE11	9851
1,8	84	05.98 - 09.00	FP55	4		RC-ZX52	8839
1,8	94	04.90 - 08.93	BP21	4		RC-ZX18	9920
1,8	96	06.89 - 04.94	BP21	4		RC-ZX18	9920
1,9	84	08.94 -	BP DOHC 16V	4		RC-ZE36	9895

323C

1,5	66	05.94 - 09.99	Z501	4		RC-ZE37	9898
-----	----	---------------	------	---	--	---------	------

323F

1,3	54	09.98 - 05.04	B35S	4		RC-ZE23	9857
1,3	54	09.98 - 01.01	B3 ME	4		RC-EZ1210	5903
1,3	55	08.98 - 05.04	B33G	4		RC-ZE23	9857
1,5	65	08.98 - 09.00	ZL05	4	Semi-Direct	RC-ZE53	8647
1,5	65	08.98 - 09.00	ZL06	4	Semi-Direct	RC-ZE53	8647
1,5	66	05.94 - 07.98	Z501	4		RC-ZE37	9898
1,6	64	06.89 - 03.91	B63M	4		RC-ZX19	9922
1,6	64	06.89 - 03.91	B63P	4		RC-ZX19	9922
1,6	64	06.89 - 03.91	B63R	4		RC-ZX19	9922
1,6	64	06.89 - 03.91	B63N	4		RC-ZX19	9922
1,6	66	04.91 - 04.94	B67J	4		RC-ZX19	9922
1,6	66	04.91 - 04.94	B67L	4		RC-ZX19	9922
1,6	72	10.00 - 10.03	ZM39	4	Semi-Direct	RC-ZE53	8647
1,6	72	10.00 - 10.03	ZM40	4	Semi-Direct	RC-ZE53	8647
1,8	76	04.90 - 08.93	BP32	4		RC-ZX18	9920
1,8	78	06.89 - 04.94	BP32	4		RC-ZX18	9920
1,8	78	06.89 - 04.94	BP52	4		RC-ZX19	9922
1,8	84	08.94 - 09.98	BP-ZE	4		RC-ZX52	8839
1,8	84	08.98 - 09.00	FP55	4		RC-ZX52	8839
1,8	85	05.94 - 09.96	BPE5	4		RC-ZE37	9898
1,8	85	10.96 - 07.98	BP3G	4		RC-ZE37	9898
1,8	85	10.96 - 07.98	BP3H	4		RC-ZE37	9898
1,8	96	06.89 - 03.94	BP30	4		RC-ZX18	9920
1,9	84	09.98 - 05.04		4		RC-ZX52	8839
2,0	106	01.95 - 07.98	KF52	6		RC-EZ1209	5945
2,0	96	01.01 - 05.04	FS7E / FS7G	4		RC-EZ1201	0352

323P

1,3	55	09.98 - 01.01	B32A	4	Mk VI	RC-ZE23	9857
1,3	55	11.96 - 10.99	B32A	4	Mk V	RC-EZ1210	5903
1,5	66	11.96 - 07.01	Z501	4	Mk V	RC-ZE37	9898
1,5	66	11.96 - 07.01	Z501	4	Semi-Direct: Mk VI	RC-ZE53	8647

616

1,6	55	06.73 - 05.82	NA	4		RC-ZE94A	9903
-----	----	---------------	----	---	--	----------	------

626

1,6	55	02.79 - 10.82	N-H6 / M-H3 / N / H8 / H6	4		RC-ZE94A	9903
1,6	59	11.82 - 06.87	GC1	4		RC-ZX99A	9932
1,6	59	02.83 - 06.87	F6	4		RC-ZX99A	9932
1,8	66	08.89 - 07.91	F8K9	4		RC-ZX16	9917



kW

C
y
I

Stock-No.

MAZDA**626**

1,8	66	05.94 - 06.97	FP01LP	4		RC-ZX29	9925
1,8	66	08.94 - 04.97	-	4		RC-ZX49	8932
1,8	66	07.97 - 09.99	FP63	4		RC-ZX49	8932
1,8	66	07.97 - 09.99	FP33	4		RC-ZX49	8932
1,8	74	01.00 - 10.02	FP9A	4		RC-ZX49	8932
1,8	77	08.91 - 04.97	FP	4		RC-ZX29	9925
1,8	77	08.91 - 01.95	FP01	4		RC-ZX29	9925
1,8	78	05.94 - 06.97	FP01HP	4		RC-ZX29	9925
1,9	66	05.97 - 01.00	FS DOHC	4		RC-ZX49	8932
1,9	77	08.91 -	FP DOHC	4		RC-ZX29	9925
2,0	66	01.79 - 12.82	M	4		RC-ZX99A	9932
2,0	66	08.87 - 07.89	FE6E	4		RC-ZX16	9917
2,0	66	08.87 - 07.89	FE6F	4		RC-ZX16	9917
2,0	66	08.87 - 07.89	FEAA	4		RC-ZX16	9917
2,0	66	08.87 - 07.89	FEAB	4		RC-ZX16	9917
2,0	74	02.83 - 07.91	FE	4		RC-ZX99A	9932
2,0	75	11.82 - 07.85	FE15	4		RC-ZE94A	9903
2,0	75	11.82 - 07.85	FE14	4		RC-ZE94A	9903
2,0	75	11.82 - 07.85	FE13	4		RC-ZE94A	9903
2,0	75	11.82 - 07.85	FE12	4		RC-ZE94A	9903
2,0	75	08.85 - 07.87	FES7	4		RC-ZE94A	9903
2,0	75	08.85 - 07.87	FES9	4		RC-ZE94A	9903
2,0	75	08.85 - 07.87	FES8	4		RC-ZE94A	9903
2,0	75	08.85 - 07.87	FES6	4		RC-ZE94A	9903
2,0	79	09.87 - 05.92	FE	4		RC-ZX15	9916
2,0	79	08.89 - 07.91	FEFJ	4		RC-EZ1208	9133
2,0	85	08.91 - 04.97	FS DOHC	4		RC-ZX29	9925
2,0	85	07.97 - 07.99	FSS9	4		RC-ZX49	8932
2,0	85	07.97 - 09.99	FSJ2LP	4		RC-ZX49	8932
2,0	85	08.99 - 10.02	FS2B	4		RC-ZX49	8932
2,0	85	08.99 - 10.02	FS2A	4		RC-ZX49	8932
2,0	86	08.85 - 07.87	FE3A	4		RC-ZE94A	9903
2,0	86	08.85 - 07.87	FE3B	4		RC-ZE94A	9903
2,0	86	08.91 - 06.97	FS84	4		RC-ZX29	9925
2,0	86	08.91 - 06.97	FS83	4		RC-ZX29	9925
2,0	88	08.85 - 07.87	FE2J	4		RC-ZE94A	9903
2,0	88	08.85 - 07.87	FEV7	4		RC-ZE94A	9903
2,0	103	08.87 - 07.91	FE6C	4		RC-ZX15	9916
2,0	103	11.87 - 05.92	FE	4	Katalysator	RC-ZX15	9916
2,0	109	06.87 - 09.89	FE	4	Katalysator	RC-ZX15	9916
2,0	109	08.87 - 07.89	FE6C	4		RC-ZX15	9916
2,0	109	08.89 - 07.91	FEFN	4		RC-ZX15	9916
2,0	115	08.91 - 06.97	FS DOHC	4		RC-ZX49	8932
2,0	115	08.91 - 04.97	FS	4		RC-ZX29	9925
2,2	85	08.87 - 07.89	F2D3	4		RC-ZX14	9914
2,2	85	08.87 - 07.89	F2D4	4		RC-ZX14	9914
2,2	85	08.89 - 07.91	F2G4	4		RC-ZX14	9914
2,2	85	08.89 - 07.91	F2G3	4		RC-ZX14	9914
2,2	85	08.89 - 07.91	F2G2	4		RC-ZX14	9914
2,5	120	08.91 - 12.96	KL	6	without coil lead	RC-ZE28	9874
2,5	121	01.97 - 06.97	KL	6		RC-ZE32B	8863

6

1,8	88	06.02 -	L813	4		RC-FD1207	6984
2,0	104	06.02 - 09.07	LF17/18	4		RC-FD1207	6984
2,0	108	03.05 - 05.10	LFF7	4		RC-FD1207	6984
2,3	119	06.02 - 08.07	L3C1	4		RC-FD1207	6984
2,3	122	06.02 - 02.08	L3C1	4		RC-FD1207	6984



kW

C
y
l

Stock-No.

MAZDA

6							
2,3	191	12.05 - 08.07	L3KG	4		RC-FD1207	6984
929							
3,0	123	06.89 - 09.92	JE34	6		RC-ZE06	9844
3,0	123	06.89 - 09.92	JE35	6		RC-ZE06	9844
3,0	140	12.86 - 05.89	JE01	6		RC-ZE06	9844
B1800							
1,8	60	06.77 - 09.81	8859	4		RC-ZE94A	9903
B2600							
2,6 Cab Plus	90	08.93 - 03.96	G634	4		RC-ZE17	2917
2,6 Cab Plus	90	04.96 - 07.98	G6T1	4		RC-ZE17	2917
2,6 Cab Plus	91	12.89 - 07.91	G612	4		RC-ZE17	2917
2,6	91	08.91 - 03.96	G612	4		RC-ZE17	2917
Demio							
1,3	46	10.99 - 10.01	B34PLP	4		RC-EZ12156	44273
1,3	53	05.98 - 09.99	B32E	4		RC-ZE23	9857
1,5	55	10.99 - 01.03	B5E2	4		RC-EZ1202	0353
1,5	55	10.99 - 10.01	B5E1	4		RC-EZ1202	0353
Eunos							
1,6	79	04.94 - 10.99	B6EX	4		RC-ZE37	9898
1,6	79	04.94 - 10.99	B6EW	4		RC-ZE37	9898
2,5 TA5A/5Y/5Z		10.93 - 07.97	KL-ZE	6		RC-ZE32B	8863
MPV							
2,0	88	11.00 - 04.02	FS1R	4	Semi-Direct	RC-EZ1201	0352
2,0	90	06.99 - 10.00	FS1R	4	Semi-Direct	RC-EZ1201	0352
2,3	104	07.02 - 02.06	L3	4		RC-FD1207	6984
MX-3							
1,6	65	07.91 - 10.93	B69	4		RC-ZE36	9895
1,6	66	03.91 -	B69J	4		RC-ZX19	9922
1,6	66	03.91 -	B69K	4		RC-ZX19	9922
1,6	79	05.91 -	B6D	4		RC-ZE36	9895
1,6	110	01.94 -	B6	4		RC-ZX18	9920
1,8	95	01.92 - 01.94	K8Y1	6		RC-ZE25	9859
1,8	95	01.92 - 01.94	K8Y1	6		RC-ZE28	9874
1,8	98	01.94 - 12.98	K819	6		RC-ZE25	9859
1,8	98	01.94 - 10.93	K819	6		RC-ZE28	9874
MX-5							
1,6	66	12.90 - 12.97	B69P	4		RC-ZE21	9856
1,6	81	01.98 - 07.00	B6MC	4		RC-ZE21	9856
1,6	85	09.89 - 08.97	B64F	4		RC-ZE21	9856
1,6	85	05.98 - 10.05	B6D	4		RC-ZE21	9856
1,8	96	09.93 - 12.97	BPF1	4		RC-ZE21	9856
1,8	103	05.98 - 10.05	BP-ZE	4		RC-ZE21	9856
1,8	107	11.00 - 10.05	BPD	4		RC-ZE21	9856
MX-6							
2,0	85	07.91 - 06.97	FS DOHC	4		RC-ZX29	9925
2,5	123	07.91 - 11.94	KLY1	6		RC-ZE28	9874
2,6 >1996	120	01.95 -	KL	6		RC-ZE32B	8863
Premacy							
1,8	74	03.99 - 07.01	F5K2	4	Semi-Direct	RC-EZ1201	0352
1,8	74	08.01 - 03.05	FPE1	4	Semi-Direct	RC-EZ1201	0352
1,8	85	03.99 - 07.01	F5K3	4	Semi-Direct	RC-EZ1201	0352



kW

C
y
i

Stock-No.

MAZDA**RX-7**

	77	02.79 - 10.81	12A	2		RC-ZE02	3941
	110	11.91 - 01.96	13B-REW	2		RC-ZE30	9881

RX-8

2,6	141	10.03 - 06.12	13B-MSP	2		RC-EZ1216	44318
2,6	170	10.03 - 06.12	13B-MSP	2		RC-EZ1216	44318

Tribute

2.0	91	03.00 -	YF	4		RC-FD1207	6984
-----	----	---------	----	---	--	-----------	------

Xedos 6

1,6	79	04.94 - 10.99	B6EX	4	>Eng No 210758	RC-ZE37	9898
1,6	79	04.94 - 10.99	B6EW	4	>Eng No 210758	RC-ZE37	9898
1,6	83	01.92 - 03.94	B69P	4		RC-ZE37	9898
1,6	83	01.92 - 03.94	B69N	4		RC-ZE37	9898
2,0	103	01.92 -	KF1	6	with coil lead	RC-ZE31	9890
2,0	105	01.92 - 10.99	KF27	6		RC-ZE28	9874

Xedos 9

2,0	105	08.93 - 01.00	KF	6	without coil lead	RC-ZE28	9874
2,3	120	07.00 -	KL	6	without coil lead	RC-ZE32B	8863
2,5	123	02.95 - 01.00	KL	6	without coil lead	RC-ZE28	9874
2,5	155	02.95 - 01.00	KJ	6	without coil lead	RC-ZE28	9874

MERCEDES**Various**

190 1,8 E	81	10.88 - 05.93	102910	4		RC-MB1105	4071
190 2,0	66	10.82 - 09.88	102921	4		RC-MB1105	4071
190 2,0	75	10.82 - 05.93	102924	4		RC-MB1105	4071
190 2,0	78	09.87 - 09.88	102924	4		RC-MB1105	4071
190 2,0 E	83	07.85 - 09.88	102961	4		RC-MB1105	4071
190 2,0 E	85	12.85 - 12.86	102962	4		RC-MB1105	4071
190 2,0 E KAT	87	10.88 - 05.93	102962	4		RC-MB207	0742
190 2,0 E	90	10.82 - 06.85	102961	4		RC-MB1105	4071
190 2,3 E	97	09.87 - 05.93	102985	4		RC-MB1105	4071
190 2,3 E	100	10.82 - 05.93	102985	4		RC-MB1105	4071
190 2,3 E-16	125	09.85 - 08.87	102983	4		RC-MB217	0752
190 2,3 E-16	130	09.87 - 09.88	102983	4		RC-MB217	0752
190 2,3 E-16	136	10.83 - 08.87	102983	4		RC-MB217	0752
190 2,5 E-16	143	01.87 - 05.93	102991	4		RC-MB217	0752
190 2,5 E-16	150	01.87 - 04.91	102990	4		RC-MB217	0752
190 2,5	173	08.89 - 06.93	102992	4		RC-MB217	0752
190 2,6 E	118	09.86 - 08.93	103942	6		RC-MB211	0746
190 2,6 E	122	09.86 - 12.89	103942	6		RC-MB211	0746
200 (123) 2,0	62	02.76 - 02.79	115939	4		RC-MB218	0753
200 (123) 2,0	70	02.76 - 08.80	115938	4		RC-MB218	0753
200 (123) 2,0	74	02.76 - 02.85	102920	4		RC-MB1105	4071
200 (123) 2,0 T	74	09.78 - 02.85	102920	4		RC-MB1105	4071
200 (124) 2,0 E	77	09.89 - 05.93	102922	4		RC-MB1105	4071
200 (123) 2,0	80	02.76 - 02.85	102920	4		RC-MB1105	4071
200 (123) 2,0 T	80	09.78 - 02.85	102920	4		RC-MB1105	4071
200 (124) 2,0 TE	80	03.85 - 08.89	102922	4		RC-MB1105	4071
200 (124) 2,0 E	87	03.85 - 08.89	102963	4		RC-MB207	0742
200 (124) 2,0 CE	87	09.89 - 05.93	102963	4		RC-MB207	0742
200 (124) 2,0 TE	90	03.85 - 08.89	102963	4		RC-MB207	0742
200 (124) 2,0 E	100	06.92 - 05.93	111940	4		RC-MB203	0738
220 (124) 2,2 E	110	08.92 - 06.93	111960	4		RC-MB203	0738



kW

C
y
l

Stock-No.

MERCEDES**Various**

220 (124) 2,2 E	110	08.92 - 06.93	111960	4	Vehicles with distributor	RC-MB1105	4071
230 (123) 2,3 C	80	02.76 - 08.79	115954	4		RC-MB218	0753
230 (123) 2,3 T	80	09.78 - 02.85	115954	4		RC-MB218	0753
230 (124) 2,3 CE KAT	97	09.89 - 05.93	102982	4		RC-MB207	0742
230 (124) 2,3 E KAT	97	09.89 - 05.93	102982	4		RC-MB207	0742
230 (124) 2,3 TE KAT	97	09.89 - 08.92	102982	4		RC-MB207	0742
230 (123) 2,3 E	100	02.76 - 02.85	102980	4		RC-MB1105	4071
230 (123) 2,3 CE	100	04.78 - 08.85	102980	4		RC-MB1105	4071
230 (123) 2,3 TE	100	09.78 - 02.85	102980	4		RC-MB1105	4071
230 (124) 2,3 E	100	12.84 - 05.93	102982	4		RC-MB1105	4071
230 (124) 2,3 TE	100	03.85 - 08.89	102982	4		RC-MB1105	4071
230 (124) 2,3 CE	100	09.86 - 07.89	102982	4		RC-MB1105	4071
250 (123) 2,5	96	10.67 - 02.79	123921	6		RC-MB219	0754
260 (124) 2,6 E	117	09.89 - 05.93	103940	6		RC-MB211	0746
260 (124) 2,6 E	120	03.85 - 08.89	103940	6		RC-MB211	0746
260 (124) 2,6 T	122	08.85 - 07.89	103940	6		RC-MB211	0746
260 (124) 2,6 E	122	08.86 - 07.89	103940	6		RC-MB211	0746
280 (123) 2,8 CE	130	02.76 - 08.79	110988	6	SAE fitment	RC-MB209	0744
280 (123) 2,8 E	130	02.76 - 08.81	110988	6	M4 fitment	RC-MB206	0741
280 (123) 2,8 CE	130	03.76 - 07.79	110988	6	M4 fitment	RC-MB206	0741
280 (124) 2,8 TE	145	06.92 - 06.93	104942	6	Semi-Direct	RC-MB202	0737
300 (124) 3,0 E	132	03.85 - 05.93	103940	6		RC-MB211	0746
300 (124) 3,0 CE	132	04.87 - 06.93	103940	6		RC-MB211	0746
300 (124) 3,0 TE	132	09.89 - 05.93	103985	6		RC-MB211	0746
300 (124) 3,0 TE	132	11.92 - 05.93	103940	6		RC-MB211	0746
300 (124) 3,0 TE	138	03.85 - 08.89	103940	6		RC-MB211	0746
300 (124) 3,0 SEL	138	09.85 - 08.89	103940	6		RC-MB211	0746
300 (124) 3,0 E	138	02.86 - 06.93	103940	6		RC-MB211	0746
300 (124) 3,0 CE	138	04.87 - 08.89	103940	6		RC-MB211	0746
300 (124) 3,0 CE-24	162	08.89 - 06.93	104980	6		RC-MB214	0749
300 (124) 3,0 E-24	162	08.91 - 06.93	104980	6		RC-MB214	0749
320 (124) 3,2 CE	162	08.91 - 06.93	104992	6	Semi-Direct	RC-MB201	0736
320 (124) 3,2 TE	162	08.92 - 05.93	104992	6	Semi-Direct	RC-MB201	0736
320 (124) 3,2 E	162	02.93 - 05.93	104992	6	Semi-Direct	RC-MB201	0736
400 (124) 4,2 E	205	08.91 - 05.93	119975	8		RC-MB213	0748
500 (124) 5,0 E	240	09.89 - 05.93	119974	8		RC-MB213	0748
E200 (124) 2,0	100	06.93 - 06.95	111940	4		RC-MB203	0738
E200 (124) 2,0	100	06.93 - 07.96	111940	4	09.95>	RC-MB222	0757
E220 (124) 2,2	110	06.93 - 06.95	111960	4		RC-MB203	0738
E220 (124) 2,2	110	06.93 - 07.96	111960	4	09.95>	RC-MB222	0757
E280 (124) 2,8	142	06.93 - 06.95	104942	6	Semi-Direct	RC-MB201	0736
E300 (124) 3,0	132	06.93 - 06.95	103985	6	Semi-Direct	RC-MB201	0736
E320 (124) 3,2	162	06.93 - 06.95	104992	6	Semi-Direct	RC-MB201	0736
E420 (124) 4,2	205	06.93 - 06.95	119975	8		RC-MB213	0748
E500 (124) 5,0	235	06.93 - 06.95	119974	8		RC-MB213	0748
230 (460) 2,3 G	66	02.79 - 08.89	115973	4		RC-MB218	0753
230 (460) 2,3 GE	90	08.86 - 08.92	102987	4		RC-MB1105	4071
230 (461) 2,3 GE	90	07.93 - 07.96	102979	4		RC-MB207	0742
230 (460) 2,3 GE	92	10.81 - 07.00	102981	4		RC-MB1105	4071
230 (460) 2,3 GE	92	10.87 - 05.93	102987	4		RC-MB1105	4071
230 (461) 2,3 GE	92	06.93 - 07.00	102996	4		RC-MB1105	4071
230 (463) 2,3 GE	93	08.86 - 06.93	102989	4		RC-MB1105	4071
230 (460) 2,3 GE	93	07.93 - 07.96	102996	4		RC-MB1105	4071
230 (460) 2,8 GE	110	07.82 - 05.93	110994	6		RC-MB1102	2580
230 (460) 2,8 GE	115	02.79 - 07.84	110994	6		RC-MB1102	2580
230 (463) 3,0 GE	125	09.89 - 05.93	103987	6		RC-MB211	0746
230 (463) 3,0 GE	126	08.89 - 06.93	103987	6		RC-MB211	0746



kW

C
y
l

Stock-No.

MERCEDES**Various**

260 (126) 2,6 SE	118	03.85 - 08.89	103941	6		RC-MB211	0746
280 (116) 2,8 S	115	08.72 - 07.80	110922	6		RC-MB208	0743
280 (116) 2,8	115	02.76 - 02.85	110922	6		RC-MB208	0743
280 (107) 2,8 SLC	125	03.71 - 02.76	110982	6		RC-MB208	0743
280 (107) 2,8 SL	125	03.71 - 02.76	110986	6		RC-MB209	0744
280 (107) 2,8 SL	125	03.71 - 02.76	110986	6		RC-MB206	0741
280 (107) 2,8 SLC	125	03.71 - 02.76	110982	6		RC-MB1102	2580
280 (123) 2,8 E	136	02.76 - 02.85	110984	6		RC-MB209	0744
280 (123) 2,8 E	136	02.76 - 02.85	110984	6		RC-MB206	0741
280 (107) 2,8 SL	136	03.76 - 07.80	110990	6	M4 fitment: 04.80>	RC-MB208	0743
280 (123) 2,8 CE	136	03.76 - 08.85	110984	6		RC-MB209	0744
280 (123) 2,8 CE	136	03.76 - 08.85	110984	6		RC-MB206	0741
280 (107) 2,8 SL	136	03.76 - 07.80	110990	6	SAE fitment: 09.81>	RC-MB1102	2580
280 (123) 2,8 TE	136	08.78 - 02.85	110984	6		RC-MB209	0744
280 (123) 2,8 TE	136	08.78 - 02.85	110984	6		RC-MB206	0741
280 (107) 2,8 SLC	136	08.80 - 08.85	110982	6	M4 fitment: 04.80>	RC-MB208	0743
280 (107) 2,8 SL	136	08.80 - 08.85	110986	6		RC-MB209	0744
280 (107) 2,8 SL	136	08.80 - 08.85	110986	6		RC-MB206	0741
280 (107) 2,8 SLC	136	08.80 - 08.85	110982	6	SAE fitment: 09.81>	RC-MB1102	2580
300 (140) 2,8 SE-24	142	06.91 - 05.93	104944	6	Semi-Direct	RC-MB201	0736
300 (107) 3,0 SL	132	08.85 - 08.89	103982	6		RC-MB211	0746
300 (108/109) 3,0 SEL	136	04.65 - 08.70	103982	6		RC-MB211	0746
300 (107) 3,0 SL	138	08.85 - 08.89	103982	6		RC-MB211	0746
300 (129) 3,0 SL	140	09.89 - 05.93	103984	6		RC-MB211	0746
300 (129) 3,0 SL-24	170	09.89 - 05.93	104981	6		RC-MB214	0749
300 (140) 3,2	170	06.91 - 06.93	104990	6	Semi-Direct	RC-MB201	0736
310 (601) 2,3	70	08.81 - 08.89	102942	4		RC-MB1105	4071
380 (126) 3,8 SEC	150	08.81 - 08.84	116963	8		RC-MB216	0751
380 (107) 3,8 SL	150	08.81 - 08.84	116962	8		RC-MB216	0751
380 (126) 3,8 SE	160	08.80 - 08.84	116960	8		RC-MB216	0751
310 (601) 2,3	70	04.82 - 07.89	102942	4		RC-MB1105	4071
420 (126) 4,2 SEL	150	09.85 - 09.86	116965	8		RC-MB215	0750
420 (107) 4,2 SL	150	09.85 - 08.89	116964	8		RC-MB215	0750
420 (126) 4,2 SEC	160	09.85 - 09.86	116965	8		RC-MB215	0750
420 (107) 4,2 SL	160	09.85 - 08.89	116964	8		RC-MB215	0750
420 (126) 4,2 SEC	162	08.89 - 05.91	116965	8		RC-MB215	0750
420 (126) 4,2 SE	165	10.86 - 07.89	116965	8		RC-MB215	0750
420 (126) 4,2 SEC	170	09.86 - 05.93	116965	8		RC-MB215	0750
420 (126) 4,2 SE	170	10.86 - 07.89	116965	8		RC-MB215	0750
500 (107) 5,0 SL	170	08.80 - 07.85	117960	8		RC-MB216	0751
500 (126) 5,0 SEC	170	08.81 - 08.85	117963	8		RC-MB216	0751
500 (126) 5,0 SEC	177	08.80 - 08.85	117963	8		RC-MB216	0751
500 (126) 5,0 SEC	185	08.87 - 06.91	117965	8		RC-MB215	0750
500 (126) 5,0 SEC	195	09.85 - 06.91	117965	8		RC-MB215	0750
400 (140) 4,2	210	02.91 - 05.93	119971	8		RC-MB213	0748
500 (140) 5,0 SE	235	05.91 - 05.93	119970	8		RC-MB213	0748
500 (140) 5,0 SEL	235	10.91 - 05.93	119970	8		RC-MB213	0748
500 (129) 5,0 SL	235	01.92 - 05.93	119972	8		RC-MB212	0747
500 (140) 5,0 SEC	235	02.92 - 05.93	119970	8		RC-MB213	0748
500 (129) 5,0 SL	240	09.89 - 05.93	119960	8		RC-MB212	0747
510 (601) 2,3	70	11.85 - 07.96	102946	4		RC-MB1105	4071
560 (126) 5,6 SE	205	08.85 - 08.87	117968	8		RC-MB215	0750
560 (126) 5,6 SEL	178	08.85 - 08.87	117968	8		RC-MB215	0750
560 (126) 5,6 SEL	200	08.85 - 08.89	117968	8		RC-MB215	0750
560 (126) 5,6 SEC	205	09.87 - 05.93	117968	8		RC-MB215	0750
560 (126) 5,6 SEC	220	09.85 - 08.87	117968	8		RC-MB215	0750



kW

C
y
l

Stock-No.

MERCEDES**A-Class**

A150 1,5	70	08.04 - 06.12	266920	4		RC-MB1106	6349
A160 1,5	70	04.09 - 06.12	266920	4		RC-MB1106	6349
A170 1,7	85	08.04 - 06.12	266940	4		RC-MB1106	6349
A180 1,7	85	04.09 - 06.12	266940	4		RC-MB1106	6349
A200 2,0	100	08.04 - 06.12	266960	4		RC-MB1106	6349
A200 2,0	142	09.05 - 06.12	M266.980	4		RC-MB1106	6349

B-Class

B150 1,5	70	03.05 - 11.11	M266.920	4		RC-MB1106	6349
B160 1,5	70	04.09 - 11.11	M266.920	4		RC-MB1106	6349
B170 1,7	85	03.05 - 11.11	M266.940	4		RC-MB1106	6349
B180 1,7	85	04.08 - 11.11	M266.940	4		RC-MB1106	6349
B200 2,0	100	03.05 - 11.11	M266.960	4		RC-MB1106	6349
B200 2,0 Turbo	142	03.05 - 11.11	M266.980	4		RC-MB1106	6349

C-Class

C180 1,8	90	06.93 - 06.97	111920	4		RC-MB203	0738
C180 1,8	90	02.96 - 06.97	111920	4		RC-MB220	0755
C180 1,8	90	07.97 - 10.00	111921	4	Semi-Direct	RC-MB222	0757
C200 2,0	100	06.93 - 07.97	111941	4		RC-MB203	0738
C200 2,0	100	08.97 - 05.00	111945	4	Semi-Direct	RC-MB222	0757
C200 2,0	100	08.97 - 10.00	111945	4		RC-MB220	0755
C200 2,0 Kompressor	141	09.95 - 05.00	111944	4	Semi-Direct	RC-MB222	0757
C220 2,2	110	06.93 - 02.96	111961	4	>08.95	RC-MB203	0738
C220 2,2	110	02.94 - 02.96	111961	4	09.95>	RC-MB222	0757
C230 2,3	110	09.95 - 06.98	111974	4	Semi-Direct	RC-MB222	0757
C230 2,3 Kompressor	142	09.95 - 05.00	111975	4	Semi-Direct	RC-MB222	0757
C240 2,4	125	09.95 - 03.01	112910	6		RC-MB223	0758
C240 2,4	125	05.00 - 08.07	112912	6		RC-MB223	0758
C240 2,6	125	06.00 -	112912	6		RC-MB223	0758
C280 2,8	142	06.93 - 10.97	104941	6	Semi-Direct	RC-MB201	0736
C280 2,8	145	02.96 - 05.00	112920	6		RC-MB223	0758
C320 3,2	160	06.00 -	112946	6		RC-MB223	0758
C32 AMG 3,2 Kompressor	260	02.01 - 08.07	112961	6		RC-MB223	0758
C55 AMG 5,4 Kompressor	270	02.04 - 08.07	113988	8		RC-MB1103	7800

CL-Class

CL500 (140) 5,0	235	07.96 - 08.99	119970	8		RC-MB213	0748
CL500 5,0	225	09.99 - 07.03	113960	8		RC-MB1103	7800
CL55 AMG 5,4	368	06.02 - 03.06	113991	8		RC-MB1103	7800

CLK

CLK200 2,0	100	04.97 - 05.00	111945	4	Semi-Direct	RC-MB222	0757
CLK200 2,0 Kompressor	141	04.97 - 07.02	111944	4	Semi-Direct	RC-MB222	0757
CLK230 2,3 Kompressor	142	04.97 - 05.00	111975	4	Semi-Direct	RC-MB222	0757
CLK240 2,6	125	06.02 - 03.10	112912	6		RC-MB223	0758
CLK320 3,2	160	04.97 - 07.02	112940	6		RC-MB223	0758
CLK320 3,2	160	06.02 - 03.10	112955	6		RC-MB223	0758
CLK430 4,3	205	04.97 - 07.02	113943	8		RC-MB1103	7800
CLK500 5,0	225	06.02 - 03.10	113968	8		RC-MB1103	7800
CLK55 AMG 5,4	255	10.98 - 07.02	113981	8		RC-MB1103	7800
CLK55 AMG 5,4	270	09.02 - 03.10	113987	8		RC-MB1103	7800

CLS

CLS500 5,0	225	10.04 - 12.10	113967	8		RC-MB1103	7800
CLS55 AMG 5,4	350	01.05 - 12.10	113990	8		RC-MB1103	7800



kW

C
y
l

Stock-No.

MERCEDES**E-Class**

E200 2,0	100	07.95 - 07.00	111942	4		RC-MB222	0757
E200 2,0 Kompressor	137	04.97 - 07.00	111947	4	Semi-Direct	RC-MB222	0757
E230 2,3	110	07.95 - 10.97	111970	4		RC-MB203	0738
E230 2,3	110	02.96 - 10.97	111970	4		RC-MB222	0757
E240 2,4	125	04.97 - 03.03	112911	6		RC-MB223	0758
E240 2,6	125	08.00 - 03.02	112914	6		RC-MB223	0758
E240 2,6	130	03.02 - 07.09	112917	6		RC-MB223	0758
E280 2,8	142	07.95 - 10.97	104945	6	Semi-Direct	RC-MB202	0737
E280 2,8	150	04.97 - 03.02	112921	6		RC-MB223	0758
E320 3,2	162	07.95 - 06.97	112995	6	Semi-Direct	RC-MB201	0736
E320 3,2	165	07.95 - 05.03	112941	6		RC-MB223	0758
E320 3,2	165	03.02 - 07.09	112949	6		RC-MB223	0758
E430 4,3	205	04.97 - 05.03	113940	8		RC-MB1103	7800
E500 5,0	225	03.02 - 07.09	113967	8		RC-MB1103	7800
E55 AMG 5,4	260	03.01 - 03.03	113980	8		RC-MB1103	7800
E55 AMG 5,4 Kompressor	350	10.02 - 07.09	113990	8		RC-MB1103	7800

G-Class

G230 2,3	93	09.93 - 07.94	102989	4		RC-MB1105	4071
G300 3,0	126	05.93 - 10.94	103987	6		RC-MB211	0746
G320 3,2	155	09.93 - 08.97	104996	6	Semi-Direct	RC-MB201	0736
G320 3,2	158	09.97 - 07.00	112945	6		RC-MB223	0758
G500 5,0	218	04.97 - 08.99	113962	8		RC-MB1103	7800

M-Class

ML230 2,3	110	04.98 - 08.00	111977	4	Semi-Direct	RC-MB222	0757
ML320 3,2	160	04.98 - 08.02	112942	6		RC-MB223	0758
ML350 3,7	173	02.03 - 06.05	112970	6		RC-MB223	0758
ML350 3,7	180	08.02 - 06.05	112970	6		RC-MB223	0758
ML430 4,3	200	11.98 - 06.05	113942	8		RC-MB1103	7800
ML500 5,0	215	09.01 - 06.05	113942	8		RC-MB1103	7800
ML500 5,0	225	07.05 -	113964	8		RC-MB1103	7800
ML55 AMG 5,4	255	06.99 - 06.05	113981	8		RC-MB1103	7800

R-Class

R500 5	225	01.06 -	113964	8		RC-MB1103	7800
--------	-----	---------	--------	---	--	-----------	------

S-Class

S280 (140) 2,8	145	06.93 - 01.99	104944	6	Semi-Direct	RC-MB201	0736
S280 2,8	150	02.99 - 08.05	112922	6		RC-MB223	0758
S320 (140) 3,2	162	10.95 - 08.98	104990	6	Semi-Direct	RC-MB201	0736
S320 3,2	165	02.99 - 08.02	112944	6		RC-MB223	0758
S320 (140) 3,2	170	06.93 - 07.98	104990	6		RC-MB214	0749
S320 (140) 3,2	170	06.93 - 07.98	104994	6	Semi-Direct	RC-MB201	0736
S350 3,7	180	09.02 - 08.05	112972	6		RC-MB223	0758
S430 4,3	205	09.98 - 08.05	113941	8		RC-MB1103	7800
S420 (140) 4,2	205	06.93 - 10.98	119971	8		RC-MB213	0748
S500 (140) 5,0	235	06.93 - 08.98	119970	8		RC-MB213	0748
S500 (140) 5,0	240	06.93 - 09.95	119970	8		RC-MB213	0748
S500 5,0	225	07.00 - 08.05	113972	8		RC-MB1103	7800
S55 AMG 5,4	368	06.02 - 08.05	113992	8		RC-MB1103	7800

SL

SL280 2,8	142	06.93 - 05.98	104943	6	Semi-Direct	RC-MB202	0737
SL280 2,8	150	06.98 - 07.01	112923	6		RC-MB223	0758
SL320 3,2	165	06.98 - 07.01	112943	6		RC-MB223	0758
SL320 3,2	170	06.93 - 05.98	104991	6	Semi-Direct	RC-MB201	0736
SL350 3,7	180	03.03 -	112973	6		RC-MB223	0758
SL500 5,0	225	06.98 - 07.01	113961	8		RC-MB1103	7800
SL500 5,0	225	08.01 -	113963	8		RC-MB1103	7800



kW

C
y
l

Stock-No.

MERCEDES**SL**

SL500 5,0	235	06.93 - 05.98	119972	8		RC-MB212	0747
SL55 AMG 5,4	350	10.01 - 06.02	113991	8		RC-MB1103	7800
SL55 AMG 5,4 Kompressor	368	06.02 - 01.12	113992	8		RC-MB1103	7800
SL55 AMG 5,4	380	03.06 - 01.12	113995	8		RC-MB1103	7800

SLK

SLK200 2,0	100	09.96 - 09.99	111946	4	Semi-Direct	RC-MB222	0757
SLK200 2,0 Kompressor	141	10.99 - 07.01	111943	4	Semi-Direct	RC-MB222	0757
SLK230 2,3 Kompressor	142	09.96 - 09.99	111973	4	Semi-Direct	RC-MB222	0757
SLK230 2,3 Kompressor	145	03.00 - 04.04	111983	4	Semi-Direct	RC-MB222	0757
SLK320 3,2	160	10.99 - 01.04	112947	6		RC-MB223	0758
SLK32 AMG 3,2	260	04.00 - 01.04	112960	6		RC-MB223	0758
SLK55 AMG 5,4	265	06.04 - 02.01	113989	8		RC-MB1103	7800

SLR

SLR 5,4	460	04.04 -	155980	8		RC-MB1103	7800
SLR 722 Edition 5,4	478	10.06 -	155980	8		RC-MB1103	7800

Sprinter

2,3 NGT	92	04.00 - 05.06	111984	4		RC-MB222	0757
2,3	105	02.95 - 05.06	111979	4		RC-MB222	0757

V-Class

V200 2,0	95	08.96 - 07.03	111948	4		RC-MB222	0757
V230 2,3	105	08.96 - 02.99	111978	4		RC-MB222	0757
V280 2,8	128	07.97 - 07.03	104900	6		RC-MB225	7065

Viano

3,0 3,2	140	09.03 -	112951	6		RC-MB223	0758
3,2 3,2	160	09.03 -	112951	6		RC-MB223	0758
3,7 3,7	170	06.04 -	112976	6		RC-MB223	0758

Vito

Vito 113 2,0	95	11.95 - 07.03	111948	4		RC-MB222	0757
Vito 114 2,3	105	08.96 - 07.03	111978	4		RC-MB222	0757
Vito 119 3,2	140	09.03 -	112951	6		RC-MB223	0758
Vito 122 3,2	160	09.03 -	112951	6		RC-MB223	0758
Vito 123 3,7	170	06.04 -	112976	6		RC-MB223	0758

MG**B**

1,8	62	09.76 - 04.80	18GB	4		RC-AT404	0542
1,8	70	09.76 - 04.80	18GB	4		RC-AT404	0542
1,8 GT	70	09.77 - 04.80	18GB	4		RC-AT404	0542
3,5 GT	101	10.72 - 08.76	V8482	8		RC-AR414	0538

F

1,8	88	04.95 - 02.02	18K4F	4		RC-RV415	0890
1,8	107	04.95 - 09.00	18K4K	4		RC-RV1203	7707
1,8	118	09.00 - 02.02	18K4Y	4	Semi-Direct	RC-RV1202	7705

Maestro

1,6	72	10.82 - 10.85	16H	4		RC-AT404	0542
2,0	83	10.83 - 09.89	20HE	4		RC-AT404	0542
2,0 Turbo	110	10.83 - 09.89	20HC	4		RC-AT404	0542

Metro

1,3	53	09.82 - 09.89	12H	4		RC-AT405	0543
-----	----	---------------	-----	---	--	----------	------

Montego

2,0	87	10.84 - 07.89	20HI	4		RC-AT404	0542
2,0 Turbo	112	10.84 - 07.89	20HT	4		RC-AT404	0542



kW

C
y
l

Stock-No.

MG**TF**

1,6	85	05.02 -	16K4F	4	Semi-Direct: Chassis No YD522573>	RC-RV1202	7705
1,8	88	02.02 -	18K4F	4	Semi-Direct: Chassis No YD522573>	RC-RV1202	7705
1,8	100	02.02 -	18K4K	4	Semi-Direct: Chassis No YD522573>	RC-RV1202	7705
1,8	118	02.02 -	18KYK	4	Semi-Direct	RC-RV1202	7705

ZR

1,4	76	08.01 -	14K4F	4	>Chassis No YD471564	RC-RV415	0890
1,4	76	11.01 -	14K4F	4	Semi-Direct	RC-RV1202	7705
1,8	86	08.01 - 09.03	18K4F	4	Semi-Direct: Chassis No YD471565>	RC-RV1202	7705
1,8	86	05.02 - 09.03	18K4F	4	Semi-Direct	RC-RV1202	7705

ZS

1,8	86	08.01 - 11.03	18K4F	4	Semi-Direct	RC-RV1202	7705
2,5	130	08.01 -	25K4F	4	Semi-Direct	RC-RV901	7408

ZT

2,5	130	04.02 -	25K4F			RC-RV901	7408
-----	-----	---------	-------	--	--	----------	------

MINI**Cooper**

1,6	85	04.01 - 09.06	W10B16A	4		RC-RV1301	2476
1,6	120	02.02 - 04.04	W11B16A	4		RC-RV1301	2476
1,6	125	05.04 - 09.06	W11B16A	4		RC-RV1301	2476
1,6	147	11.03 - 06.05	W11B16AW	4		RC-RV1301	2476
1,6	155	11.03 - 09.06	W11B16AW	4		RC-RV1301	2476

One

1,4	55	04.03 - 09.06	W10B14A	4		RC-RV1301	2476
1,6	66	04.01 - 07.07	W10B16A	4		RC-RV1301	2476

MINI (GB)**de Tomaso**

1,0 Turbo	40	01.78 - 04.84	99S	4		RC-AT405	0543
-----------	----	---------------	-----	---	--	----------	------

Moke

1,0	28	03.63 - 09.69	99L	4		RC-AT405	0543
1,0	29	10.69 - 09.83	99H	4		RC-AT405	0543
1,0	34	10.88 - 04.90	99H	4		RC-AT405	0543

MINI (GB)**Carisma**

1,3	55	09.00 - 10.04	4G13	4	Semi-Direct	RC-EM1202	0347
1,6	66	03.95 - 05.99	4G92	4	Semi-Direct	RC-ME96	4104
1,6	66	03.95 - 05.99	4G92	4		RC-ME79	8735
1,6	73	08.97 - 05.99	4G92	4	Semi-Direct	RC-ME96	4104
1,6	73	08.97 - 05.99	4G92	4		RC-ME79	8735
1,6	76	06.99 - 06.04	4G92	4	Semi-Direct	RC-ME96	4104
1,8	85	03.95 - 10.97	4G93	4	Semi-Direct	RC-ME96	4104
1,8	85	03.95 - 10.97	4G93	4		RC-ME79	8735
1,8	90	01.99 - 05.00	4G93	4	Semi-Direct	RC-ME96	4104
1,8	92	06.00 - 05.04	4G93	4	Semi-Direct	RC-ME96	4104

Celeste

2,0	66	03.76 - 01.77	4G52	4		RC-EM1206	5900
2,0	71	02.77 - 01.79	4G52	4		RC-EM1206	5900
2,0	77	02.79 - 05.80	4G52	4		RC-EM1206	5900

Challenger

3,0	130	11.97 - 10.00	6G72DOHC	6		RC-ME95	5074
-----	-----	---------------	----------	---	--	---------	------



kW

C
y
l

Stock-No.

MITSUBISHI**Chariot**

1,8	88	05.91 - 08.93	4G93	4		RC-ME79	8735
2,0	63	09.88 - 04.91	4G63	4		RC-ME59	9302
2,0	77	05.91 - 10.97	4G63	4		RC-ME59	9302

Colt

1,2	40	05.84 - 04.88	4G16	4		RC-ME59	9302
1,2	44	09.86 - 04.88	4G16	4		RC-ME59	9302
1,3	44	04.88 - 07.90	G13B	4		RC-ME59	9302
1,3	51	01.86 - 06.90	G15B	4		RC-ME59	9302
1,3	55	07.90 - 07.01	4G13	4		RC-ME74	5071
1,3	60	08.01 - 05.04	4G13	4		RC-ME74	5071
1,4	51	12.78 - 01.84	4G12	4		RC-ME54	9296
1,4 Turbo	77	05.82 - 10.83	4G12T	4		RC-ME54	9296
1,5	51	07.85 - 04.88	G15B	4		RC-ME59	9302
1,5	55	05.84 - 04.88	G15B	4		RC-ME59	9302
1,5	62	05.88 - 06.90	G15B	4		RC-ME59	9302
1,5	66	07.90 - 11.91	4G15	4		RC-ME59	9302
1,6	66	03.96 - 07.01	4G92	4	Semi-Direct	RC-ME96	4104
1,6	66	03.96 - 07.01	4G92	4		RC-ME79	8735
1,6	76	08.01 - 05.04	4G92	4	Semi-Direct	RC-ME96	4104
1,6	84	12.91 - 02.96	4G92	4		RC-ME79	8735
1,6 GTi	91	05.88 - 11.91	4G61DOHC	4		RC-ME64	8741
1,6 Turbo	92	01.84 - 04.88	4G32	4	C13A	RC-ME54	9296
1,8 GTi	103	12.91 - 02.96	4G93DOHC	4		RC-ME109	2553

Cordia

1,6	55	06.82 - 11.85	4G32	4		RC-EM1207	5917
-----	----	---------------	------	---	--	-----------	------

Eclipse

2,0	107	05.96 - 10.00	4G63DOHC	4		RC-ME64	8741
2,0	110	12.89 - 04.96	4G63DOHC	4		RC-ME64	8741
2,0 Turbo	147	05.96 - 10.00	4G63DOHC	4		RC-ME64	8741
2,0 Turbo	157	05.96 - 10.00	4G63DOHC	4		RC-ME64	8741

FTO

2,0	125	10.95 - 08.00	6A12	6		RC-ME78	8752
-----	-----	---------------	------	---	--	---------	------

Galant

1,6	51	03.77 - 03.78	4G32	4		RC-EM1207	5917
1,6	55	04.78 - 07.80	4G32	4		RC-EM1207	5917
1,6	75	06.80 - 06.84	4G63	4		RC-EM1203	9120
1,8	63	01.88 - 10.92	4G37	4		RC-ME51	9293
1,8	66	01.88 - 10.92	4G37	4		RC-EM1206	5900
1,8	66	01.88 - 10.92	4G37	4		RC-ME79	8735
1,8	85	11.92 - 09.96	4G93	4		RC-ME79	8735
1,8	93	11.92 - 09.96	4G93	4		RC-ME79	8735
2,0	66	02.86 - 12.87	4G63	4		RC-ME59	9302
2,0	66	02.86 - 12.87	4G63	4		RC-EM1203	9120
2,0	75	06.84 - 12.87	4G63	4		RC-ME59	9302
2,0	80	01.88 - 12.91	4G63	4		RC-ME59	9302
2,0	98	08.01 - 10.03	4G63	4	Semi-Direct	RC-ME96	4104
2,0	98	08.01 - 10.03	4G63	4		RC-EM1203	9120
2,0	98	08.01 - 10.03	4G63	4		RC-ME79	8735
2,0	100	11.92 - 07.01	4G63	4		RC-ME79	8735
2,0	100	10.96 - 07.01	4G63	4		RC-ME59	9302
2,0	100	10.96 - 07.01	4G63	4		RC-EM1203	9120
2,0	101	11.92 - 09.96	4G63	4		RC-ME79	8735
2,0 GTi	107	01.88 - 10.92	4G63DOHC	4		RC-ME64	8741
2,0	107	01.90 - 10.92	4G63DOHC	4		RC-ME64	8741
2,0	109	11.87 - 10.92	4G63	4	E33A	RC-ME64	8741
2,0 Turbo	110	07.84 - 05.86	4G63T	4		RC-ME59	9302



kW

C
y
l

Stock-No.

mitsubishi**Galant**

2.0	110	11.92 - 09.96	6A12	6		RC-ME78	8752
2.0 Turbo	125	06.80 - 06.84	4G63T	4		RC-ME59	9302
2.4	82	06.85 - 12.87	4G64	4		RC-ME59	9302
2.4	92	06.85 - 12.87	4G64	4		RC-ME59	9302
2.4 GDI	110	12.99 - 10.03	4G64	4	Semi-Direct	RC-ME96	4104
2.5	118	08.01 - 10.03	6A13DOHC	6		RC-ME111	2555
2.5	120	10.96 - 07.01	6A13DOHC	6		RC-ME111	2555

Galloper

3.0	104	05.98 - 08.02	G6AT	6		RC-HD404	0706
-----	-----	---------------	------	---	--	----------	------

L200

2.0	90	09.96 - 07.01	4G63	4		RC-ME106A	5762
2.4	97	11.96 - 07.01	4G64	4		RC-ME106A	5762
2.6	76	11.89 - 05.92	G54B	4		RC-ME51	9293

L300

1.6	51	02.80 - 05.94	4G32	4		RC-EM1207	5917
1.8	60	03.83 - 08.85	4G62	4		RC-ME59	9302
2.0	63	08.88 - 05.94	4G63	4		RC-EM1207	5917
2.0	65	09.85 - 10.86	4G63	4		RC-ME59	9302
2.0	65	09.85 - 05.94	4G63	4		RC-EM1207	5917
2.0	65	11.86 - 07.88	G63B	4		RC-EM1207	5917
2.0	78	06.94 - 08.95	4G63	4		RC-ME59	9302
2.0	78	06.94 - 08.95	4G63	4		RC-EM1207	5917
2.0	83	09.95 - 10.98	4G63	4		RC-ME59	9302
2.0	83	09.95 - 10.98	4G63	4		RC-EM1207	5917
2.4	82	11.86 - 05.94	G64B	4		RC-ME59	9302
2.4	82	11.86 - 05.94	4G64	4		RC-ME59	9302
2.4	82	08.88 - 05.94	4G64	4		RC-EM1207	5917

Lancer

1.2	40	04.82 - 04.84	4G11	4		RC-EM1206	5900
1.2	40	05.84 - 04.88	4G16	4		RC-ME59	9302
1.2	44	05.88 - 10.91	4G16	4		RC-ME59	9302
1.3	44	07.90 - 07.93	4G13	4		RC-ME59	9302
1.3	55	07.90 - 07.01	4G13	4		RC-ME59	9302
1.3	60	09.03 -	4G13	4		RC-ME59	9302
1.3	44	-	4G13	4	without coil lead	RC-ME74	5071
1.3	55	-	G13B	4	without coil lead	RC-ME74	5071
1.4	51	10.79 - 01.84	4G12	4		RC-EM1206	5900
1.5	51	07.85 - 04.88	G15B	4		RC-ME59	9302
1.5	55	02.84 - 04.88	G15B	4		RC-ME59	9302
1.5	55	07.85 - 05.92	G15B	4	>05.90	RC-ME59	9302
1.5	62	07.85 - 05.92	G15B	4	>05.90	RC-ME59	9302
1.5	62	05.88 - 06.90	G15B	4		RC-ME59	9302
1.5	66	07.90 - 08.03	4G15	4		RC-MX1202	7700
1.5		-	4G15	4	without coil lead	RC-ME74	5071
1.5		-	G15B	4	without coil lead	RC-ME74	5071
1.6	60	10.79 - 01.84	4G32	4		RC-EM1207	5917
1.6	66	08.93 - 07.01	4G92	4		RC-ME79	8735
1.6	72	09.03 -	4G18	4		RC-EM1202	0347
1.6	83	09.97 - 08.03	4G92	4	Semi-Direct	RC-ME96	4104
1.6	84	06.92 - 09.97	4G92	4		RC-ME79	8735
1.6 GTi	91	05.88 - 05.90	4G61	4		RC-ME64	8741
1.8	63	01.87 - 05.92	4G37	4		RC-ME59	9302
1.8	66	01.87 - 05.92	4G37	4		RC-ME59	9302
1.8 GTi	66	06.92 - 07.93	4G37	4		RC-ME59	9302
1.8	70	01.87 - 07.93	4G37	4		RC-ME59	9302
1.8 GTi	70	06.92 - 07.93	4G37	4		RC-ME59	9302
1.8 GTi	100	06.90 - 07.93	4G67DOHC	4		RC-ME64	8741



kW

C
y
l

Stock-No.

MITSUBISHI**Lancer**

1,8 GTi	103	08.93 - 02.96	4G93DOHC	4		RC-ME109	2553
2,0	100	05.03 - 12.07	4G63DOHC	4		RC-EM1211	44317

Libero

1,3		-	4G13	4	without coil lead	RC-ME74	5071
1,5		-	4G15	4	without coil lead	RC-ME74	5071

Mirage

1,3		-	4G13	4	without coil lead	RC-ME74	5071
1,5		-	4G15	4	without coil lead	RC-ME74	5071
1,5		-	G15B	4	without coil lead	RC-ME74	5071

Montero

3,0	110	03.91 - 10.97	6G72	6		RC-ME95	5074
-----	-----	---------------	------	---	--	---------	------

Outlander

2,0	100	05.03 - 10.06	4G63DOHC	4	Semi-Direct	RC-EM1211	44317
-----	-----	---------------	----------	---	-------------	-----------	-------

Pajero

1,8	84	11.01 -	4G93DOHC	4	Semi-Direct	RC-ME96	4104
1,8	88	05.99 - 02.01	4G93DOHC	4	Semi-Direct	RC-ME96	4104
2,0	95	10.00 -	4G94	4	Semi-Direct	RC-ME96	4104
2,6	76	01.83 - 02.91	4G54	4		RC-ME51	9293
3,0	104	01.89 - 02.91	6G72	6		RC-ME61	8648
3,0	110	03.91 - 10.97	6G72	6	05.94>	RC-ME61	8648
3,0	110	03.91 - 10.97	6G72	6	>05.94	RC-ME95	5074
3,0	130	11.97 - 08.99	6G72DOHC	6		RC-ME95	5074
3,5	143	11.97 - 08.99	6G74DOHC	6	Semi-Direct	RC-ME95	5074
3,5	149	09.99 -	6G74DOHC	6	Semi-Direct	RC-ME95	5074
3,5	153	11.93 - 10.97	6G74DOHC	6	Semi-Direct	RC-ME95	5074

RVR

1,8	85	06.91 - 09.99	4G93	4		RC-ME79	8735
2,0		-	4G63	4		RC-ME77	5072

Sapporo

1,6	55	09.79 - 06.84	4G32	4		RC-EM1207	5917
1,6	75	09.79 - 06.84	4G32	4		RC-EM1207	5917
2,0	75	06.80 - 06.84	4G63	4		RC-EM1203	9120
2,0	81	06.80 - 06.84	4G63	4		RC-EM1203	9120
2,4	91	02.87 - 12.90	4G64	4		RC-ME59	9302

Shogun

1,8	84	03.01 -	4G93	4	Semi-Direct	RC-ME96	4104
1,8	88	05.99 - 02.01	4G93DOHC	4	Semi-Direct	RC-ME96	4104
2,6	76	01.84 - 02.91	4G54	4		RC-ME51	9293
3,0	104	06.89 - 02.91	6G72	6		RC-ME95	5074
3,0	110	03.91 - 10.97	6G72	6		RC-ME95	5074
3,5	143	11.93 - 10.97	6G74DOHC			RC-ME95	5074

Space

1,3 Star	60	08.00 - 12.05	4G13	4	Semi-Direct	RC-EM1202	0347
1,3 Star	63	08.98 - 07.00	4G13	4	Semi-Direct	RC-EM1202	0347
1,6 Star	72	04.01 - 12.05	4G18	4	Semi-Direct	RC-EM1202	0347
1,8 Wagon	66	10.83 - 04.91	4G37	4		RC-EM1203	9120
1,8 Star	82	08.02 - 12.05	4G93DOHC	4	Semi-Direct	RC-ME96	4104
1,8 Runner	85	06.91 - 09.99	4G93	4		RC-ME79	8735
1,8 Star	87	06.98 - 12.05	4G93	4	Semi-Direct	RC-ME96	4104
1,8 Runner	90	06.91 - 09.99	4G93	4		RC-ME79	8735
1,8 Wagon	90	06.91 - 10.98	4G93	4		RC-ME79	8735
1,8 Star	90	08.98 - 07.00	4G93DOHC	4	Semi-Direct	RC-ME96	4104
2,0 Wagon	62	06.86 - 05.88	G63B	4		RC-ME106A	5762



kW

C
y
l

Stock-No.

mitsubishi**Space**

2,0 Wagon	75	10.83 - 04.91	4G63	4		RC-ME59	9302
2,0 Wagon	75	10.83 - 05.88	4G63	4		RC-ME106A	5762
2,0 Wagon	80	12.98 - 06.02	4G63	4		RC-ME59	9302
2,0 Wagon	80	12.98 - 06.02	4G63	4		RC-ME106A	5762
2,0 Gear	83	06.96 - 05.00	4G63	4		RC-ME106A	5762
2,0 Gear	85	12.94 - 05.96	4G63	4		RC-ME106A	5762
2,0 Wagon	100	06.92 - 11.98	4G63DOHC	4		RC-ME79	8735
2,0 Runner	100	10.99 - 04.03	4G63DOHC	4	Semi-Direct	RC-ME96	4104
2,4 Gear	97	12.94 - 05.00	4G64	4		RC-ME106A	5762
2,4 Wagon	108	12.98 - 08.03	4G64DOHC	4	Semi-Direct	RC-ME96	4104
2,4 Runner	110	10.99 - 07.03	4G64DOHC	4	Semi-Direct	RC-ME96	4104

MORRIS**Ital**

1,0	59	09.80 - 12.84	17V	4		RC-AT402	0540
2,0	69	09.80 - 09.82	20V	4		RC-AT402	0540

Marina

1,3	32	02.70 - 10.75	A	4		RC-AT405	0543
1,7	41	11.75 - 10.80	12H	4		RC-AT405	0543

Minor

0,8	27	06.59 - 08.69	8F	4		RC-AT405	0543
0,9	28	11.55 - 12.61	9A	4		RC-AT405	0543
1,1	37	01.62 - 10.71	H99	4		RC-AT405	0543

MOSKVIICH (AZLK)**21412**

1,5	51	01.86 -	-	4		RC-MX1205	4947
-----	----	---------	---	---	--	-----------	------

214122

1,5	51	01.86 -	-	4		RC-MX1205	4947
-----	----	---------	---	---	--	-----------	------

Aleko (2141)

1,5	53	08.87 - 09.93	15CA	4		RC-MX1205	4947
-----	----	---------------	------	---	--	-----------	------

NISSAN**100**

1,6	66	10.90 - 09.92	GA16DS	4		RC-NX11	5075
1,6	66	10.90 - 09.92	GA16DS	4		RC-NX07	9459
1,6	75	10.92 - 07.96	GA16DE	4		RC-NE08	9405
2,0 GTi	105	10.90 - 09.95	SR20DE	4		RC-NX07	9459
2,0 GTi	105	10.90 - 09.95	SR20DE	4		RC-NX11	5075
2,0 GTi	110	10.90 - 09.92	SR20DE	4		RC-NX07	9459

140Y

1,4	46	08.78 - 08.80	A14	4		RC-HE32	9105
-----	----	---------------	-----	---	--	---------	------

160J

1,6	65	01.78 - 12.82	L16S	4		RC-HE32	9105
-----	----	---------------	------	---	--	---------	------

240K

2,4	94	09.78 - 10.84	L24E	6		RC-RV1204	5401
-----	----	---------------	------	---	--	-----------	------

280

2,8 ZX, ZXT	147	02.81 - 08.83	L28ET	6		RC-NE61	9409
-------------	-----	---------------	-------	---	--	---------	------

300

3,0 ZX	125	07.83 - 12.89	VG30E	6		RC-NE77A	2679
--------	-----	---------------	-------	---	--	----------	------

1000

1,0	33	05.69 - 07.76	A10	4		RC-FT431	0678
-----	----	---------------	-----	---	--	----------	------



kW

C
y
l

Stock-No.

NISSAN**Almera**

1,4	55	07.95 - 03.00	GA14DE	4		RC-NE08	9405
1,4	64	07.95 - 03.00	GA14DE	4		RC-NE08	9405
1,6	66	07.95 - 03.00	GA16DE	4		RC-NE08	9405
1,6	75	07.95 - 03.00	GA16DE	4		RC-NE08	9405
2,0	100	08.00 - 05.03	SR20DE	4		RC-EN1208	44265
2,0 GTi	105	07.96 - 03.00	SR20DE	4		RC-NE08	9405

Bluebird

1,6	60	07.86 - 04.90	CA16S	4		RC-NE64	8517
1,6	61	11.83 - 02.88	CA16S	4		RC-NE64	8517
1,6	66	12.85 - 02.90	CA16S	4		RC-NE64	8517
1,8	61	03.88 - 04.90	CA18N	4		RC-NE64	8517
1,8	65	12.83 - 12.85	CA18S	4		RC-NE64	8517
1,8	66	07.86 - 04.90	CA18N	4		RC-NE64	8517
1,8 EU13; KEU13		-	SR18DE	4		RC-NX11	5075
1,8 EU14; KEU14		-	-	4		RC-NX11	5075
2,0	66	12.85 - 02.90	CA20S	4		RC-NE64	8517
2,0	75	11.83 - 04.90	CA20S	4		RC-NE64	8517
2,0	77	12.85 - 04.90	CA20E	4		RC-NE64	8517
2,0	77	03.88 - 07.92	CA20S	4		RC-NE64	8517
2,0	85	12.85 - 04.90	CA20E	4		RC-NE64	8517
2,0	85	02.88 - 06.89	CA20S	4		RC-NE64	8517
2,0		-	SR20DE; SR20 DET	4		RC-NX11	5075

Cherry

1,0	37	08.81 - 07.86	E10	4		RC-NX71	9464
1,2	38	02.75 - 07.81	A12	4		RC-AR403	0527
1,3	44	08.81 - 07.86	E13	4		RC-NX71	9464

King Cab

2,0	66	09.85 - 05.94	Z20	4		RC-EN1204	9163
2,4	93	05.92 - 01.98	KA24E	4		RC-RV303	8268

Kubistar

1,2	44	08.03 -	D7F 764	4		RC-RN1204	6794
1,2	55	04.06 -	DAF 712	4		RC-RN1311	44278

Laurel

2,0	71	03.77 - 12.80	L20S	6		RC-RV1204	5401
2,0	72	01.81 - 10.84	L20A	6		RC-RV1204	5401
2,0	96	-	RB20E	6		RC-NX81A	5076
2,4	83	01.81 - 01.84	L24	6		RC-EN1211	44326
2,4	88	09.83 - 12.85	L24	6		RC-EN1211	44326

Maxima

3,0	125	12.88 - 09.94	VG30E	6		RC-NX91	9480
-----	-----	---------------	-------	---	--	---------	------

Micra

1,0	37	12.82 - 07.92	MA10S	4		RC-NX71	9464
1,0	40	12.88 - 07.92	MA10S	4		RC-NX71	9464
1,0	40	08.92 - 08.00	CG10DE	4		RC-NE09	9985
1,0	43	12.88 - 07.92	MA10S	4		RC-NX71	9464
1,0	44	09.00 - 02.03	CG10DE	4		RC-NE09	9985
1,2	42	07.85 - 07.92	MA12S	4		RC-NX71	9464
1,3	55	08.92 - 08.00	CG13DE	4		RC-NE09	9985
1,4	60	09.00 - 02.03	CGA3DE	4		RC-EN1207	6857

Patrol

4,2	125	10.91 - 09.97	TB42E	6		RC-NE29	5764
-----	-----	---------------	-------	---	--	---------	------



kW

C
y
l

Stock-No.

NISSAN**Pick Up**

1,6	51	12.80 - 05.84	J16	4		RC-EN1210	44325
2,0	66	09.85 - 05.94	Z20	4		RC-EN1204	9163
2,4 King Cab	87	02.98 - 10.01	KA24E	4		RC-RV303	8268
2,4	93	05.92 - 12.94	KA24E	4		RC-NX93	9482

Prairie

1,5	55	01.83 - 09.88	E15	4		RC-NX71	9464
1,8	65	01.83 - 09.88	CA18S	4		RC-EN1204	9163
2,0	66	10.89 - 03.92	CA20S	4		RC-NE64	8517
2,0	68	06.86 - 09.88	CA20S	4		RC-NE64	8517
2,0	72	10.88 - 03.92	CA20S	4		RC-NE64	8517
2,4	98	04.92 - 07.94	KA24E			RC-RV303	8268

Primera

1,6	66	06.90 - 01.96	GA16D	4		RC-NX07	9459
1,6	66	07.90 - 01.96	GA16DS	4		RC-NX11	5075
1,6	66	05.93 - 12.02	GA16DEL	4		RC-NE08	9405
1,6	71	06.90 - 01.96	GA16D	4		RC-NX07	9459
1,6	71	06.90 - 01.96	GA16D	4		RC-NX11	5075
1,6	75	05.93 - 01.96	GA16DE	4		RC-NX11	5075
1,6	75	03.94 - 03.98	QG16DE	4		RC-NE08	9405
1,6	78	09.00 -	QG16DE	4		RC-NE08	9405
1,6	80	01.02 -	QG16DE	4		RC-NX11	5075
2,0	85	05.90 - 05.96	SR20DI	4		RC-EN1201	0349
2,0	85	06.96 - 12.01	SR20DE	4		RC-NE08	9405
2,0	92	05.93 - 05.96	SR20DE	4		RC-NE08	9405
2,0	96	06.96 - 07.02	SR20DE	4		RC-NE08	9405
2,0 ZX	103	09.90 - 04.93	SR20DE	4		RC-NE08	9405
2,0	103	06.99 - 12.01	SR20DE	4		RC-NE08	9405
2,0	105	06.90 - 12.01	SR20DE	4		RC-NE08	9405
2,0 ZX	105	09.90 - 04.93	SR20DE	4		RC-NX11	5075
2,0 ZX	110	05.90 - 04.93	SR20DEH	4		RC-NE08	9405
2,0	110	06.90 - 05.99	SR20DEH	4		RC-NE08	9405

Pulsar

1,6	73	07.95 - 12.99	GA16DE	4		RC-NE08	9405
1,6	75	10.92 - 06.95	GA16DE	4		RC-NE08	9405

Serena

1,6	71	07.92 - 09.01	GA16DE	4		RC-EN1202	0351
1,6	75	10.94 - 12.00	GA16DE	4		RC-EN1202	0351
2,0	92	07.92 - 12.00	SR20DE	4		RC-EN1202	0351
2,0 PC24; PNC24		-	SR20DE	4		RC-NX11	5075

Silvia

1,8 Turbo	90	07.86 - 04.88	CA18ET	4		RC-EN1204	9163
1,8 Turbo	100	10.83 - 06.86	CA18ET	4		RC-EN1204	9163

Stanza

1,6	60	08.81 - 12.85	CA16S	4		RC-EN1204	9163
1,8	65	08.81 - 12.85	CA18S	4		RC-EN1204	9163

Sunny

1,3	44	09.81 - 10.88	E13	4		RC-NX71	9464
1,4	55	10.88 - 09.90	GA14S	4		RC-EN1203	9027
1,4	55	10.90 - 06.95	GA14DS	4	10.92>	RC-NX11	5075
1,4	55	10.90 - 06.95	GA14DS	4	>09.92	RC-NX07	9459
1,4	55	10.90 - 06.95	GA14DE	4		RC-NE08	9405



kW

C
y
l

Stock-No.

NISSAN**Sunny**

1,4	64	10.90 - 06.95	GA14DE	4		RC-NE08	9405
1,5	55	03.82 - 10.88	E15S	4		RC-NX71	9464
1,6	54	06.86 - 05.89	E16I	4		RC-NX71	9464
1,6	62	06.86 - 09.88	E16I	4		RC-NX89	9478
1,6	62	06.86 - 10.88	E16S	4		RC-NX71	9464
1,6	66	07.86 - 09.90	E16I	4		RC-NX71	9464
1,6	66	07.86 - 09.90	E16I	4		RC-NX89	9478
1,6	66	10.88 - 09.90	GA16I	4		RC-NX89	9478
1,6	66	10.88 - 09.90	GA16S	4		RC-NX89	9478
1,6	66	10.90 - 03.94	GA16DS	4		RC-NX07	9459
1,6	66	10.90 - 03.94	GA16DE	4		RC-NX11	5075
1,6	70	10.88 - 09.90	GA16S	4		RC-NX89	9478
1,6	75	10.90 - 03.00	GA16DE	4		RC-NE08	9405
1,6	81	06.86 - 09.88	CA16D	4		RC-NX89	9478
1,6 GTi	81	07.87 - 10.88	CA16D	4		RC-NX89	9478
1,6	88	06.86 - 10.88	GA16DE	4		RC-NX11	5075
1,6		-	SR16VE	4		RC-NX11	5075
1,8		-	SR18DE	4		RC-NX11	5075
2,0	105	10.90 - 06.95	SR20DE	4		RC-EN1201	0349
2,0 GTiR	162	10.90 - 06.95	SR20DET	4		RC-EN1201	0349

Terrano

2,4	76	08.87 -	Z24i	4		RC-NX87	9475
2,4	87	02.93 - 02.02	KA24E	4		RC-RV303	8268
2,4	91	02.93 - 06.96	KA24E	4		RC-NX93	9482
2,4	91	07.96 - 12.97	KA24E	4		RC-RV303	8268
2,4	93	02.93 - 06.96	KA24E	4		RC-RV303	8268
3,0	95	10.87 - 11.89	VG30E	6		RC-EN1206	6375
3,0	109	10.87 - 01.93	VG30E	6		RC-EN1206	6375

Vanette

1,5 KC120	51	01.83 - 12.87	A15	4		RC-NX25	3453
1,6	72	01.96 -	GA16DE	4		RC-NX07	9459

Violet (140J)

1,4	46	01.78 - 12.82	A14	4		RC-NE64	8517
-----	----	---------------	-----	---	--	---------	------

NISSAZUK**Nysazuk**

		-	-	6		RC-FT415	0661
--	--	---	---	---	--	----------	------

OPEL**Antara**

2,4	104	05.06 -	Z24XE / Z24XED	4		RC-OP440	0810
-----	-----	---------	----------------	---	--	----------	------

Ascona

1,2	40	08.75 - 08.78	12N	4		RC-OP301	8265
1,3	55	09.81 - 08.88	13S	4		RC-OP455	0825
1,6	51	09.81 - 10.88	16N	4		RC-OP402	0772
1,6	55	09.85 - 10.88	C16LZ	4		RC-OP455	0825
1,6	55	08.86 - 10.88	E16NZ	4		RC-OP455	0825
1,6 S GT	55	09.86 - 08.87	C16LZ	4		RC-OP455	0825
1,6	55	08.87 - 10.88	C16NZ	4		RC-OP455	0825
1,6	60	09.82 - 10.88	16SV	4		RC-OP455	0825
1,6	66	09.81 - 08.85	16SH	4		RC-OP402	0772
1,6 S GT	66	09.84 - 08.86	16SH	4		RC-OP402	0772
1,8	62	09.86 - 10.88	E18NV	4		RC-OP426	0796
1,8 GT	74	09.85 - 10.88	C18NE	4		RC-OP427	0797
1,8	74	09.86 - 08.87	C18NE	4		RC-OP427	0797



kW

C
y
l

Stock-No.

OPEL**Ascona**

1,8 S GT	74	09.87 - 10.88	S18NV	4		RC-OP426	0796
1,8	85	09.81 - 08.84	18E	4		RC-OP427	0797
1,9	55	02.70 - 08.81	19N	4		RC-OP402	0772
1,9	66	02.70 - 08.81	19S	4		RC-OP402	0772
2,0	66	06.78 - 08.81	20N	4		RC-OP402	0772
2,0	74	06.78 - 08.81	20S	4		RC-OP402	0772
2,0	74	09.87 - 10.88	C2ONEF	4		RC-OP426	0796
2,0	81	06.78 - 08.83	20E	4		RC-OP402	0772
2,0	85	09.83 - 10.88	20NE	4		RC-OP426	0796
2,0	85	09.85 - 10.88	C2ONE	4		RC-OP426	0796
2,0 E GT	85	09.85 - 10.88	20NE	4		RC-OP426	0796
2,0 GT	85	09.86 - 08.87	C2ONE	4		RC-OP426	0796
2,0 GT	95	09.83 - 10.88	20SEH	4		RC-OP426	0796

Astra

1,4 Classic	44	01.98 - 01.05	X14NZ	4		RC-OP419	0789
1,4	44	09.91 - 08.94	C14NZ	4	Eng No 02BF1477 & 19241624>	RC-OP1209	6257
1,4 Classic	44	01.98 - 01.05	X14NZ	4		RC-OP1219	6257
1,4 GT	44	09.91 - 08.92	C14NZ	4	Eng No 19241624, 02BE1477>	RC-OP1209	6257
1,4	44	09.91 - 08.96	C14NZ	4	>Eng No 19241623 & Eng No 02V57974 - 02BE1476	RC-OP436	0806
1,4 Classic	44	01.98 - 01.05	X14NZ	4		RC-OP436	0806
1,4 GT	44	09.91 - 08.92	C14NZ	4	>Eng No 19241623 & Eng No 02V57974 - 02BE1476	RC-OP436	0806
1,4	44	09.92 - 08.96	C14NZ	4	Eng No 19241624, 02BE1477>	RC-OP1209	6257
1,4	44	01.98 - 01.05	X14NZ	4		RC-OP1209	6257
1,4	55	09.91 - 08.94	14NV	4	>Eng No 02V57973	RC-OP419	0789
1,4	55	09.91 - 08.94	14NV	4	Eng No 19241624, 02BE1477>	RC-OP1209	6257
1,4	55	09.91 - 08.94	14NV	4	>Eng No 02V57973	RC-OP436	0806
1,4	55	09.93 - 08.94	14NV	4	>Eng No 19241623 & Eng No 02V57974 - 02BE1476	RC-OP436	0806
1,4 GT	60	09.91 - 10.92	C14SE	4	Eng No 19880551>, Eng No 02T14053 - 02BD1413	RC-OP434	0804
1,4 GT	60	09.91 - 10.92	C14SE	4	Eng No 19280317, 02BD1414>	RC-OP1208	4069
1,4	60	11.91 - 07.93	14SE	4	Eng No 19880551>, Eng No 02T14053 - 02BD1413	RC-OP434	0804
1,4	60	11.91 - 07.93	14SE	4		RC-OP1208	4069
1,4	60	05.93 - 03.01	C14SE	4		RC-OP1204	6990
1,4	60	11.91 - 07.93	14SE	4		RC-OP1204	6990
1,4	60	09.92 - 08.96	C14SE	4	>Eng No 02T14052 & 19880550	RC-OP1208	4069
1,4	60	03.92 - 03.01	C14SE	4	>Eng No 02T14052	RC-OP436	0806
1,4	60	09.92 - 03.01	C14SE	4	Eng No 19880551>, Eng No 02T14053 - 02BD1413	RC-OP434	0804
1,4	60	05.93 - 08.96	C14SE	4	Eng No 19280317, 02BD1414>	RC-OP1208	4069
1,4	60	09.93 - 03.01	C14SE	4		RC-OP1208	4069
1,4	66	09.96 - 08.00	X14XE	4		RC-OP438	0808
1,6	52	06.93 - 08.94	X16SZ	4		RC-OP434	0804
1,6	52	06.93 - 08.94	X16SZ	4		RC-OP1208	4069
1,6	55	09.91 - 08.94	C16NZ	4	>Eng No 02BE6166	RC-OP1204	6990
1,6 GT	55	04.92 - 08.93	C16NZ	4	>Eng No 02BE6166	RC-OP1204	6990
1,6	55	04.92 - 01.98	C16NZ	4	>Eng No 02V65825	RC-OP1217	1689
1,6	55	09.91 - 01.98	C16NZ	4		RC-OP434	0804
1,6	55	09.94 - 08.96	X16SZ	4		RC-OP1208	4069
1,6	55	09.95 - 08.96	X16SZ	4	>Eng No 02BE6165	RC-OP434	0804
1,6	55	09.95 - 01.98	C16SZR	4		RC-OP1204	6990
1,6	55	09.91 - 01.98	C16NZ	4	02BE6167 >	RC-OP453	0823
1,6	55	09.96 - 02.98	X16SZR	4		RC-OP434	0804
1,6	55	09.96 - 02.98	X16SZR	4	Eng No 02BE6166>	RC-OP1208	4069



kW

C
y
i

Stock-No.

OPEL

Astra							
1,6	55	03.98 - 08.00	X16SZR	4		RC-OP1208	4069
1,6	62	09.00 - 07.04	Z16SE	4		RC-OP1208	4069
1,6 GT	74	09.91 - 08.94	C16SE	4	Eng No 02BD0921>	RC-OP1208	4069
1,6 GT	74	09.91 - 08.94	C16SE	4	Eng No 02V65826 - 02BD0920	RC-OP434	0804
1,6	74	09.93 - 08.94	C16SE	4	>Eng No 02V65825	RC-OP1208	4069
1,6	74	09.93 - 08.94	C16SE	4	Eng No 02V65826 - 02BD0920	RC-OP434	0804
1,6	74	09.94 - 08.02	X16XEL	4	>Eng No 20C17332	RC-OP438	0808
1,6	74	09.94 - 01.05	X16XEL	4		RC-OP1101	6307
1,6	76	12.02 - 12.09	Z16XEP	4		RC-OP1101	6307
1,6	77	03.04 -	Z16XEP	4		RC-OP1101	6307
1,8	66	09.91 - 07.95	C18NZ	4	>Eng No 14349311	RC-OP418	0788
1,8	66	08.95 - 09.98	C18NZ	4	Eng No 14349312>	RC-OP1219	1585
1,8 GT	66	04.92 - 07.95	C18NZ	4	>Eng No 14349311	RC-OP418	0788
1,8 GT	66	08.95 - 09.98	C18NZ	4	Eng No 14349312>	RC-OP1219	1585
1,8	85	09.94 - 08.96	C18XEL	4		RC-OP440	0810
1,8	85	08.95 - 02.98	X18XE	4		RC-OP440	0810
1,8 GT	92	09.93 - 08.94	C18XE	4		RC-OP440	0810
2,0	85	09.91 - 08.94	C20NE	4	>Eng No 14672353	RC-OP418	0788
2,0	85	09.91 - 08.94	C20NE	4	Eng No 14672354>	RC-OP1219	1585
2,0	85	09.91 - 08.94	C20NE	4	Chassis No S2500001, S5000001, S6000001, S8000001>	RC-OP448	0818
2,0 GT	85	04.92 - 08.93	C20NE	4	>Eng No 14672353	RC-OP418	0788
2,0 GT	85	04.92 - 08.94	C20NE	4	Eng No 14672354>	RC-OP1219	1585
2,0 GT	85	04.92 - 08.94	C20NE	4	Chassis No S2500001, S5000001, S6000001, S8000001>	RC-OP448	0818
2,0 GSi	100	09.94 - 08.96	X20XEV	4		RC-OP440	0810
2,0	100	09.96 - 08.00	X20XEV	4		RC-OP440	0810
2,0	110	09.91 - 01.98	C20XE	4		RC-OP204	0769
2,0	110	09.91 - 01.98	C20XE	4		RC-VX1202	6983
2,0	118	10.99 - 08.00	X20XER	4		RC-OP440	0810
Calibra							
2,0	85	08.89 - 12.96	C20NE	4	>Chassis No R1 / R5 / R7	RC-OP1213	8745
2,0	85	08.89 - 12.96	C20NE	4	Eng No 14672353 - R1....., R9....	RC-OP418	0788
2,0	85	08.89 - 12.96	C20NE	4	Chassis No S1....., S9...	RC-OP442	0812
2,0	100	09.94 - 08.96	X20XEV	4		RC-OP440	0810
2,0	110	08.89 - 08.96	C20XE	4	Chassis No P1000001 & P9000001>	RC-OP440	0810
2,0	110	08.89 - 08.96	C20XE	4	Eng no 14180385 >	RC-OP203	0768
2,0	110	08.90 - 07.93	C20XE	4	>Chassis no N1999999	RC-OP204	0769
2,0 Turbo	150	08.91 - 08.96	C20LET	4		RC-OP204	0769
2,5	125	09.93 - 05.98	C25XE	6		RC-OP450	0820
Campo							
2,3	69	08.91 - 08.94	4 ZD1	4		RC-OP1210	1410
2,3	72	08.94 - 09.96	4 ZD1	4		RC-OP1215	1401
Combo							
1,2	33	11.92 - 07.96	C12NZ/X12SZ	4	Eng No 02BD0922>	RC-OP1208	4069
1,2	33	08.95 - 07.01	C12NZ/X12SZ	4	>Eng No 02BD0921	RC-OP434	0804
1,2	33	08.95 - 07.01	C12NZ/X12SZ	4		RC-OP432	0802
1,2	40	08.84 - 08.87	12SC	4		RC-VX415	0986
1,3	44	09.84 - 08.89	13N	4		RC-OP455	0825
1,3	44	09.84 - 08.87	13NB	4		RC-OP455	0825
1,3	44	09.87 - 08.88	C13N	4		RC-OP455	0825
1,4	44	09.91 - 08.96	C14NZ	4	>Eng No 198019893	RC-OP444	0814
1,4	44	09.91 - 08.96	C14NZ	4	Eng No 02W91253 - 02BF1475	RC-OP432	0802
1,4	44	09.91 - 08.96	C14NZ	4	Eng No 02BF1476>	RC-OP444	0814
1,4	55	08.89 - 08.92	14NV	4		RC-OP436	0806



kW

C
y
l

Stock-No.

OPEL**Combo**

1,4	60	08.94 - 08.96	C14SE	4	>Eng No 02T14052	RC-OP432	0802
1,4	60	08.94 - 08.96	C14SE	4	Eng No 02T14053>	RC-OP434	0804
1,4	66	08.99 - 10.01	X14XE	4	Eng No 02T14053>	RC-OP438	0808
1,6	55	09.84 - 08.89	16S	4		RC-OP402	0772
1,6	55	08.89 - 08.93	C16NZ	4		RC-OP455	0825
1,6	60	09.89 - 08.91	16SV	4		RC-OP1204	6990
1,6	60	09.89 - 10.91	16SV	4		RC-OP455	0825
1,6	62	08.01 -	Z16SE	4		RC-OP1208	4069

Commodore

2,5	85	03.67 - 08.82	25/28	6		RC-OP459	0829
-----	----	---------------	-------	---	--	----------	------

Corsa

1,0	33	09.82 - 08.90	10S	4		RC-OP1202	2590
1,2	33	09.82 - 08.90	12NC / E12GV	4	> Engine No 0106700	RC-OP1202	2590
1,2	33	09.82 - 07.90	12NC / E12GV	4	Engine No > 0106701	RC-OP307	7080
1,2	33	08.87 - 07.90	12NC / E12GV	4		RC-OP436	0806
1,2	33	09.89 - 09.90	C12NZ	4		RC-OP458	0828
1,2	33	04.93 - 05.97	12NZ	4	>Eng No 19334656	RC-OP432	0802
1,2	33	09.90 - 12.01	C12NZ	4	>Eng No 19334656	RC-OP432	0802
1,2	33	04.93 - 12.01	X12SZ	4	>Eng No 19330000	RC-OP434	0804
1,2	33	04.93 - 12.01	C12NZ	4	Eng No 19334657>	RC-OP444	0814
1,2	33	04.93 - 05.97	12NZ	4	Eng No 19334657>	RC-OP444	0814
1,2	33	04.93 - 12.01	X12SZ	4	Eng No 19330001>	RC-OP1208	4069
1,2	37	09.82 - 07.94	12NV	4		RC-OP408	0778
1,2	40	09.82 - 08.90	12ST	4	SAE fitment	RC-OP408	0778
1,2	44	09.82 - 08.90	12S	4		RC-OP408	0778
1,3	44	09.82 - 08.90	13NB	4		RC-OP408	0778
1,3	44	04.85 - 08.88	C13N	4		RC-OP408	0778
1,3	51	09.82 - 08.90	13SB	4		RC-OP408	0778
1,3 GT	51	09.85 - 08.87	13SB	4		RC-OP408	0778
1,3	55	09.82 - 08.90	13S	4		RC-OP408	0778
1,4	40	08.88 - 03.93	C14NZ	4		RC-OP432	0802
1,4	44	08.88 - 03.93	C14NZ	4		RC-OP432	0802
1,4	44	04.93 - 09.00	C14NZ	4	>Engine No 02BF1475 & 19241622	RC-OP432	0802
1,4 without air con	44	04.93 - 09.00	C14NZ	4	Engine No 02BF1476 & 19241623>	RC-OP444	0814
1,4 with air con	44	04.93 - 09.00	C14NZ	4	Engine No 02BF1476 & 19241623>	RC-OP423	0793
1,4	44	08.96 - 09.00	X14SZ	4	>Eng No 02HY3579 & 19747137	RC-OP304	8458
1,4	44	08.96 - 09.00	X14SZ	4	Eng No 02HY3580>	RC-OP1208	4069
1,4	55	08.88 - 03.93	14NV	4		RC-OP432	0802
1,4 GT	60	09.89 - 03.93	C14SE	4	>Eng No 02T14052	RC-OP432	0802
1,4 GT	60	09.89 - 03.93	C14SE	4	Eng No 02T14053>	RC-OP434	0804
1,4	60	04.93 - 08.94	C14SE	4	>Eng No 19262000	RC-OP434	0804
1,4	60	04.93 - 08.94	C14SE	4	Eng No 19262001>	RC-OP1208	4069
1,4	60	08.94 - 05.97	C14SE	4	Eng No 02BD1413>	RC-OP1208	4069
1,4	60	08.94 - 05.97	C14SE	4	>Eng No 02BD1412	RC-OP434	0804
1,4	66	04.98 - 07.00	X14XE	4		RC-OP438	0808
1,6	55	09.88 - 08.90	C16NZ	4	SAE fitment	RC-OP455	0825
1,6	74	08.88 - 03.93	E16SE	4		RC-OP447	0817
1,6	74	08.88 - 03.93	C16SE	4		RC-OP423	0793
1,6	74	08.96 - 08.00	C16SEL	4	>Eng No 20C71331	RC-OP438	0808
1,6	78	08.96 - 08.00	X16XE	4		RC-OP438	0808
1,6	80	04.93 - 08.00	C16XE	4	>Eng No 20C71331	RC-OP438	0808
1,6	80	04.93 - 08.00	C16XE	4	Eng No 20C71331>	RC-OP204	0769

Frontera

2,0	85	08.91 - 08.95	C20NE	4	>Eng No 14672353	RC-OP412	0782
2,0	85	08.91 - 08.95	C20NE	4	Eng No 14672354>	RC-OP430	0800
2,0	85	09.95 - 08.98	X20SE	4		RC-OP465	0835



kW

C
y
l

Stock-No.

**OPEL
Frontera**

2,2	100	03.95 - 08.98	X22XE	4		RC-OP1211	8822
2,2	100	09.98 - 06.00	X22SE	4		RC-OP1211	8822
2,2	100	07.00 - 07.04	Y22SE	4		RC-OP1211	8822
2,4	92	08.91 - 02.95	C24NE	4		RC-OP421	0791

Kadett

1,0	29	08.62 - 07.65	10N	4		RC-DW1206	5976
1,0	30	09.74 - 07.79	10N	4		RC-OP1202	2590
1,0	30	09.79 - 08.82	10N	4		RC-DW1206	5976
1,2	40	09.74 - 07.86	12N	4		RC-OP1202	2590
1,2	40	09.79 - 07.86	12N	4		RC-OP1202	2590
1,2	40	09.81 - 07.86	12ST	4		RC-OP1202	2590
1,2	40	08.85 - 07.86	12SC	4		RC-OP1202	2590
1,3	44	09.79 - 08.84	13N	4		RC-OP402	0772
1,3	44	09.79 - 08.84	13N	4		RC-OP408	0778
1,3	44	09.79 - 08.87	13N	4		RC-OP455	0825
1,3	44	09.82 - 08.84	13N	4	SAE fitment	RC-OP408	0778
1,3	44	09.82 - 08.91	13N	4	DIN fitment	RC-OP402	0772
1,3	44	09.84 - 08.87	13NB	4		RC-OP455	0825
1,3	44	09.87 - 05.92	C13N	4		RC-OP408	0778
1,3	55	09.79 - 08.90	13S	4		RC-OP455	0825
1,3	55	09.86 - 12.89	13S	4		RC-OP408	0778
1,4	44	09.84 - 05.92	C14NZ	4		RC-OP436	0806
1,4	55	09.88 - 05.92	14NV	4		RC-OP436	0806
1,6	55	09.79 - 08.87	16S	4		RC-OP402	0772
1,6 GT	55	09.84 - 08.87	16S	4		RC-OP402	0772
1,6	55	09.86 - 08.91	C16NZ/LZ	4		RC-OP402	0772
1,6	55	09.86 - 08.91	C16NZ/LZ	4		RC-OP455	0825
1,6	55	09.86 - 05.92	C16NZ/LZ	4		RC-OP1204	6990
1,6	55	09.87 - 05.92	E16NZ	4		RC-OP1204	6990
1,6 GT	55	09.88 - 08.91	C16NZ	4		RC-OP1204	6990
1,6 GT	55	09.88 - 08.91	C16LZ	4		RC-OP1204	6990
1,6	60	09.84 - 08.87	16SV	4	SAE fitment: >Eng No 02E85672	RC-OP455	0825
1,6	60	07.89 - 02.93	16SV	4		RC-OP1204	6990
1,6	60	09.86 - 08.91	16SV	4		RC-OP436	0806
1,6 GTS	60	09.86 - 08.91	16SV	4	SAE fitment: >Eng No 02E85672	RC-OP455	0825
1,6	66	08.81 - 08.87	16SH	4		RC-OP402	0772
1,6	66	09.84 - 08.87	16SH	4		RC-OP402	0772
1,6	75	09.87 - 05.92	E16NZ	4		RC-OP1204	6990
1,6 GT	75	08.88 - 08.90	E16NZ	4		RC-OP1204	6990
1,8	62	08.86 - 09.90	E18NV	4	M4 fitment: Eng No 14258180 - 14275381	RC-OP418	0788
1,8	62	08.86 - 09.90	E18NV	4	M4 fitment: Eng No 14275382 >	RC-OP1219	1585
1,8	62	08.86 - 09.90	E18NV	4	DIN fitment: >Eng No 14258179	RC-OP426	0796
1,8	66	08.89 - 05.92	C18NZ/NT	4	>Eng No 14349310	RC-OP418	0788
1,8	66	08.89 - 05.92	C18NZ/NT	4		RC-OP427	0797
1,8	66	08.89 - 05.92	C18NZ/NT	4	Eng No 14349311>	RC-OP1219	1585
1,8	74	08.85 - 05.92	C18NE	4		RC-OP427	0797
1,8 GT-E	85	09.81 - 08.84	18E	4		RC-OP427	0797
1,8	85	09.84 - 07.85	18E	4		RC-OP427	0797
1,8 GT	85	09.88 - 05.92	18E	4		RC-OP427	0797
2,0	85	09.86 - 08.90	C20NE	4	M4 fitment: Eng No 14180386 - 14672352	RC-OP418	0788
2,0	85	09.86 - 08.90	C20NE	4	DIN fitment	RC-OP426	0796
2,0	85	09.86 - 08.91	C20NE	4	M4 fitment: Eng No 14672353>	RC-OP1219	1585
2,0	95	09.84 - 08.90	20NE	4		RC-OP426	0796
2,0	95	09.86 - 08.90	20NE	4	DIN fitment	RC-OP426	0796
2,0 GT	95	09.87 - 05.92	20NE	4		RC-OP426	0796
2,0 GSi	110	09.88 - 05.92	C20XE	4	14mm Dist	RC-OP203	0768



kW

C
y
l

Stock-No.

OPEL**Kadett**

2,0 GSi	110	09.88 - 05.92	C20XE	4	17mm Dist	RC-OP204	0769
2,0 GSi	115	12.87 - 10.91	20XE	4	14mm Dist	RC-OP203	0768
2,0 GSi	115	12.87 - 10.91	20XE	4	17mm Dist	RC-OP204	0769

Manta

1,8 GT	66	08.81 - 07.87	18S	4		RC-OP402	0772
1,8 GT	66	08.81 - 07.87	18S	4		RC-ST405	0906
1,9	55	08.76 - 07.80	19N	4		RC-OP402	0772
1,9	65	02.70 - 08.75	19N	4		RC-OP402	0772
1,9	66	02.70 - 07.80	19S	4		RC-OP402	0772
1,9 GT-E	77	08.72 - 08.75	19E	4		RC-OP402	0772
1,9	77	08.75 - 07.80	19E	4		RC-OP402	0772
2,0	66	08.77 - 07.81	20N	4		RC-OP402	0772
2,0	74	08.77 - 07.84	20S	4		RC-OP402	0772
2,0	81	08.77 - 07.81	20E	4		RC-OP402	0772
2,0 GT-E	81	08.79 - 07.85	20E	4		RC-OP402	0772
2,0 Gsi	81	08.81 - 07.88	20E	4		RC-OP402	0772

Meriva

1,6	64	04.03 - 07.04	Z16SE	4		RC-OP1208	4069
-----	----	---------------	-------	---	--	-----------	------

Monza

2,2	85	09.83 - 08.85	22E	4		RC-OP402	0772
2,8	103	09.77 - 08.87	28H	6		RC-OP459	0829
3,0	110	09.77 - 08.82	30H	6		RC-OP459	0829
3,0	132	09.77 - 08.87	30E	6		RC-OP459	0829

Omega

1,8	60	09.86 - 08.88	18NV	4	DIN fitment: >Chassis No K1000098	RC-OP411	0781
1,8	60	09.86 - 08.88	18NV	4	M4 fitment: >Chassis No L1204907	RC-OP412	0782
1,8	66	09.86 - 08.87	18SV	4	DIN fitment: >Chassis No K1000098	RC-OP411	0781
1,8	66	09.86 - 08.89	18NV	4		RC-OP412	0782
1,8	66	09.86 - 08.87	18SV	4	M4 fitment: >Chassis No L1204907	RC-OP412	0782
1,8	66	09.86 - 08.89	18NV	4		RC-OP411	0781
1,8	66	09.86 - 08.87	18SV	4	Chassis No L1204908 & K1000099>	RC-OP430	0800
1,8	85	09.86 - 08.87	18SEH	4	M4 fitment: >Chassis No L1204907	RC-OP412	0782
1,8	85	09.86 - 08.87	18SEH	4	DIN fitment: >Chassis No K1000098	RC-OP411	0781
1,8	85	09.86 - 08.87	18SEH	4	Chassis No L1204908 & K1000099>	RC-OP430	0800
2,0	73	08.90 - 04.94	C20NEJ	4	DIN fitment	RC-OP411	0781
2,0	73	08.90 - 04.94	C20NEJ	4	M4 fitment	RC-OP412	0782
2,0	74	08.90 - 04.94	C20NEF	4	DIN fitment	RC-OP411	0781
2,0	74	08.90 - 04.94	C20NEF	4	M4 fitment: 01.91>	RC-OP412	0782
2,0	74	08.90 - 04.94	C20NEF	4	M4 fitment: 01.93>	RC-OP430	0800
2,0	85	09.86 - 04.94	C20NE/SE	4	DIN fitment	RC-OP411	0781
2,0	85	09.86 - 04.94	C20NE/SE	4	M4 fitment	RC-OP412	0782
2,0	85	09.86 - 04.94	C20NE/SE	4	01.93>	RC-OP430	0800
2,0	85	09.94 - 05.99	X20SE	4		RC-OP1208	4069
2,0	90	09.86 - 08.87	20SE	4	M4 fitment	RC-OP412	0782
2,0	90	09.86 - 08.87	20SE	4	DIN fitment	RC-OP411	0781
2,0	90	09.86 - 08.87	20SE	4	01.93>	RC-OP430	0800
2,0	100	05.94 - 05.99	X20XEV	4		RC-OP440	0810
2,4	92	09.87 - 08.92	C24NE	4		RC-OP421	0791
2,5	125	05.94 - 07.00	X25XE	6	> Eng no 8145499	RC-OP1206	4061
2,5	125	05.94 - 07.00	X25XE	6	Eng no 8145500 >	RC-OP1205	4059
2,6	110	09.89 - 08.92	C26NE	6		RC-OP414	0784
3,0	115	09.86 - 08.88	C30LE	6	DIN fitment: >Chassis No K1000098	RC-OP459	0829
3,0	130	09.86 - 08.87	C30LE	6	>Eng No 01026690 Chassis No K1000099>	RC-OP1212	1590
3,0	130	09.87 - 04.94	C30LE	6	M4 fitment: Eng No 01026691>	RC-OP413	0783
3,0	130	09.86 - 08.87	30NE / C30NE	6	DIN fitment: >Chassis No K1000098	RC-OP459	0829



kW

C
y
i

Stock-No.

OPEL**Omega**

3,0	130	09.87 - 04.94	30NE / C30NE	6	>Eng No 01026690 Chassis No K1000099>	RC-OP1212	1590
3,0	130	09.87 - 04.94	30NE / C30NE	6	M4 fitment: Eng No 01026691>	RC-OP413	0783
3,0	150	09.88 - 04.94	C30SEJ	6		RC-OP466	0836
3,0 MV6	155	05.94 - 07.00	X30XE	6	> Eng no 8145499	RC-OP1206	4061
3,0	155	09.99 - 07.00	X30XE	6	Eng no 8145500 >	RC-OP1205	4059

Rekord

1,7	44	03.63 - 08.86	17N	4		RC-OP402	0772
1,7	49	09.71 - 08.75	17N	4		RC-OP402	0772
1,7	55	04.64 - 08.71	17S	4		RC-OP402	0772
1,7	55	09.65 - 08.66	17N	4		RC-OP402	0772
1,7	61	09.71 - 01.78	17S	4		RC-OP402	0772
1,8	55	09.81 - 08.86	18N	4		RC-OP402	0772
1,8	66	09.81 - 08.86	18S	4		RC-OP402	0772
1,8	74	09.84 - 08.86	C18NV	4		RC-OP402	0772
1,9	55	09.65 - 08.82	19N	4		RC-OP402	0772
2,0	66	09.77 - 08.81	20N	4		RC-OP402	0772
2,0	74	09.71 - 08.86	20S	4		RC-OP402	0772
2,0	81	09.77 - 08.84	20E	4		RC-OP402	0772
2,2	85	08.83 - 08.86	22E	4		RC-OP402	0772

Senator

2,2	85	09.83 - 08.87	22E	4		RC-OP402	0772
2,5	103	09.87 - 08.90	25NE	6	DIN fitment: >Chassis No K1000098	RC-OP459	0829
2,5	103	09.87 - 08.90	25NE	6	>Eng No 01055888 Chassis No K1000099>	RC-OP1212	1590
2,5	103	09.87 - 08.90	25NE	6	M4 fitment: Eng No 01055889>	RC-OP413	0783
2,6	110	09.87 - 08.93	C26NE	6		RC-OP414	0784
2,8	103	06.78 - 07.80	28H	6		RC-OP459	0829
3,0	150	09.88 - 04.94	C30SE	6		RC-OP466	0836
3,0	115	09.84 - 08.87	C30LE	6		RC-OP413	0783
3,0	115	09.84 - 08.87	C30LE	6		RC-OP459	0829
3,0	115	09.87 - 08.93	C30LE	6	DIN fitment: >Chassis No K1000098	RC-OP459	0829
3,0	115	09.87 - 08.93	C30LE	6	>Eng No 01026690 Chassis No K1000099>	RC-OP1212	1590
3,0	115	09.87 - 08.93	C30LE	6	M4 fitment: Eng No 01026691>	RC-OP413	0783
3,0	130	09.87 - 08.93	30NE / C30NE	6	DIN fitment: >Chassis No K1000098	RC-OP459	0829
3,0	130	09.87 - 08.93	30NE / C30NE	6	>Eng No 01026690 Chassis No K1000099>	RC-OP1212	1590
3,0	130	09.87 - 08.93	30NE / C30NE	6	M4 fitment: Eng No 01026691>	RC-OP413	0783
3,0	150	09.89 - 08.93	C30SE	6		RC-OP466	0836
3,0	132	06.78 - 08.87	30E	6		RC-OP459	0829
3,0	150	09.88 - 08.93	C30SEJ	6		RC-OP466	0836

Sintra

2,2	104	11.96 - 09.99	X22XE	4		RC-OP440	0810
3,0	148	11.96 - 09.99	X30XE	6		RC-OP1206	4061

Tigra

1,4	66	09.94 - 04.01	X14XE	4		RC-OP438	0808
1,6	78	09.94 - 04.01	X16XE	4		RC-OP438	0808

Vectra

1,4	55	08.88 - 07.92	14NV	4	M4 fitment	RC-OP432	0802
1,6	52	08.93 - 08.95	X16SZ	4	Chassis No. R100000, R500000, R7500001>	RC-OP1208	4069
1,6	52	08.93 - 08.95	X16SZ	4	>Chassis No P199999	RC-OP434	0804
1,6	52	08.88 - 08.95	C16NZ/2	4		RC-OP442	0812
1,6	55	08.88 - 08.95	C16NZ/2	4	> Eng no 02N52986	RC-OP1217	1689
1,6	55	08.88 - 08.95	C16NZ/2	4	Eng no 02N52987 > ; > Chassis No R1000000	RC-OP1204	6990
1,6	55	08.88 - 08.95	C16NZ/2	4	Chassis no R100001 >	RC-OP1218	8707



kW

C
y
l

Stock-No.

OPEL**Vectra**

1,6	55	09.88 - 10.90	E16NZ	4	> Eng no 02N52986	RC-OP1217	1689
1,6	55	09.88 - 10.90	E16NZ	4	Eng no 02N52987 > ; > Chassis No P5299999, P1299999, PV299999"	RC-OP1204	6990
1,6	55	09.88 - 10.90	E16NZ	4	Chassi no R100001, R5000001, R7500001	RC-OP1218	8707
1,6	55	09.93 - 11.95	X16SZ	4		RC-OP1208	4069
1,6	55	09.93 - 11.95	X16SZ	4		RC-OP1208	4069
1,6	55	09.95 - 07.03	X16SZR	4		RC-OP1208	4069
1,6	55	09.95 - 07.03	16LZ2	4		RC-OP442	0812
1,6	60	08.88 - 06.94	16SV	4	M4 fitment	RC-OP432	0802
1,6	60	08.88 - 06.94	16SV	4	SAE fitment	RC-OP455	0825
1,6	60	09.95 - 08.96	16LZ2	4		RC-OP442	0812
1,6	65	08.88 - 06.94	E16NZ	4	Eng No 02V65826>	RC-OP1204	6990
1,6	65	08.88 - 06.94	E16NZ	4	>Eng No 02V65825	RC-OP455	0825
1,6	74	09.95 - 07.02	X16XEL	4	Chassis No -W1238518, -W5276825	RC-OP438	0808
1,6	74	09.95 - 07.02	X16XEL	4	Chassis No -W1238518, -W5276825	RC-OP438	0808
1,8 GT	65	08.88 - 07.89	E18NVR	4	Eng no 141802386 > >Eng No 14349310	RC-OP418	0788
1,8 GT	65	08.88 - 07.89	E18NVR	4	Eng No 14349311 > ; Chassis no S1/S5/S7 >	RC-OP442	0812
1,8 GT	65	08.88 - 07.89	E18NVR	4	Eng No 14349311 > > ; > Chassis No R1/R5/R7	RC-OP1213	8745
1,8 GT	65	08.88 - 07.89	E18NVR	4	DIN Fitment	RC-OP426	0796
1,8	66	08.88 - 10.90	18SV	4	Eng no 141802386 > >Eng No 14349310	RC-OP418	0788
1,8	66	08.88 - 10.90	18SV	4	Eng No 14349311 > ; Chassis no S1/S5/S7 >	RC-OP442	0812
1,8	66	08.88 - 10.90	18SV	4	Eng No 14349311 > > ; > Chassis No R1/R5/R7	RC-OP1213	8745
1,8	66	08.88 - 10.90	18SV	4	DIN Fitment	RC-OP426	0796
1,8	66	09.88 - 11.95	C18NZ	4	Eng no 141802386 > >Eng No 14349310	RC-OP418	0788
1,8	66	09.88 - 11.95	C18NZ	4	Eng No 14349311 > ; Chassis no S1/S5/S7 >	RC-OP442	0812
1,8	66	09.88 - 11.95	C18NZ	4	Eng No 14349311 > > ; > Chassis No R1/R5/R7	RC-OP1213	8745
1,8	85	09.95 - 12.98	X18XE	4		RC-OP440	0810
2,0	82	09.95 - 02.02	20NEJ	4		RC-OP1208	4069
2,0	85	09.88 - 10.90	20NE	4	Eng no 141802386 > >Eng No 14349310	RC-OP418	0788
2,0	85	09.88 - 10.90	20NE	4	Eng No 14349311 > ; Chassis no S1/S5/S7 >	RC-OP442	0812
2,0	85	09.88 - 10.90	20NE	4	Eng No 14349311 > > ; > Chassis No R1/R5/R7	RC-OP1213	8745
2,0	85	09.88 - 11.95	C20NE	4	Eng no 141802386 > >Eng No 14349310	RC-OP418	0788
2,0	85	09.88 - 11.95	C20NE	4	Eng No 14349311 > ; Chassis no S1/S5/S7 >	RC-OP442	0812
2,0	85	09.88 - 11.95	C20NE	4	Eng No 14349311 > > ; > Chassis No R1/R5/R7	RC-OP1213	8745
2,0	85	08.88 - 07.92	20NE	4	DIN fitment	RC-OP426	0796
2,0	85	08.88 - 08.95	C20NE	4	DIN fitment	RC-OP426	0796
2,0	95	08.88 - 09.92	20SEH	4	>Eng No 14180385	RC-OP1214	1683
2,0	95	08.88 - 09.92	20SEH	4	Eng No 14180386>	RC-OP418	0788
2,0	95	08.88 - 09.92	20SEH	4	Eng No 14672353>	RC-OP430	0800
2,0	100	08.92 - 06.00	X20XEV	4	Including LPG	RC-OP440	0810
2,0	110	08.89 - 11.95	C20XE	4	With Coil lead	RC-OP204	0769
2,0	110	08.89 - 11.95	C20XE	4		RC-OP440	0810
2,0	110	08.89 - 11.95	C20XE	4		RC-OP201	0766
2,0	110	08.89 - 11.95	C20XE	4	With Coil lead	RC-OP202	0767
2,0 Turbo	150	08.92 - 06.94	C20LET	4		RC-OP204	0769
2,5	125	08.92 - 08.95	C25XE	6		RC-OP450	0820
2,5	125	09.95 - 06.00	X25XE	6		RC-SB408	0898
2,5	143	05.98 - 06.00	X25XE	6		RC-SB408	0898



kW

C
y
l

Stock-No.

OTOSAN**Anadol**

1,3	42	10.70 - 08.76	KL13	4		RC-FD804	8537
1,3	43	09.76 - 08.82	KL13H	4		RC-FD804	8537

PEUGEOT**104**

1,0	33	08.73 - 07.79	XV3	4		RC-PG618	7294
1,0	33	08.79 - 07.87	XV5	4		RC-PG618	7294
1,1	36	08.78 - 07.87	XW7	4		RC-PG618	7294
1,1	42	08.75 - 07.80	XW3	4		RC-PG618	7294
1,1	49	08.75 - 08.82	XW3S	4		RC-PG618	7294
1,2	42	08.79 - 07.83	XZ5	4		RC-PG618	7294
1,4	52	08.79 - 07.83	XY6B	4		RC-PG618	7294
1,4	59	08.79 - 08.82	XY6B	4		RC-PG618	7294

106

1,0	33	08.91 - 10.94	TU9	4		RC-CT601	7371
1,0	33	08.91 - 03.01	TU9M	4		RC-CT615	7285
1,0	37	08.91 - 03.96	TU9M	4		RC-CT601	7371
1,0	37	08.91 - 03.01	TU9M	4		RC-CT615	7285
1,1	40	03.98 - 03.01	TU1M	4		RC-CT615	7285
1,1	44	08.91 - 03.96	TU1	4		RC-CT601	7371
1,1	44	08.91 - 03.96	TU1M	4		RC-CT601	7371
1,1	44	04.96 - 03.01	TU1M	4		RC-CT615	7285
1,1	44	09.00 - 10.02	TU1JP	4		RC-CT615	7285
1,3	72	08.91 - 03.96	TU2J2	4		RC-CT615	7285
1,4	51	08.91 - 10.94	TU3	4		RC-CT615	7285
1,4	55	08.91 - 10.94	TU3MC	4		RC-CT615	7285
1,4	55	08.91 - 10.94	TU3MC	4		RC-CT601	7371
1,4	55	04.96 - 07.04	TU3JP	4		RC-CT615	7285
1,6	66	04.94 - 10.99	TU5JP	4		RC-CT615	7285
1,6	74	04.94 - 01.01	TU5J2	4		RC-CT615	7285

204

1,1	39	10.65 - 08.69	XK	4		RC-SE83	8748
1,1	40	09.69 - 12.77	XK4	4		RC-SE83	8748
1,1	43	09.75 - 12.77	XK5	4		RC-SE83	8748

205

1,0	32	02.83 - 07.90	XV8	4		RC-PG604	7374
1,0	33	08.87 - 06.94	TU9 / XV8	4		RC-CT601	7371
1,1	36	02.83 - 07.87	XW7	4		RC-CT601	7371
1,1	36	02.83 - 07.90	XW7	4		RC-PG604	7374
1,1	40	08.87 - 12.94	TU1	4		RC-CT601	7371
1,1	44	08.87 - 05.97	TU1M	4		RC-CT601	7371
1,3	74	08.87 - 07.92	TU24	4		RC-CT601	7371
1,4	44	02.83 - 07.87	XYR	4		RC-PG604	7374
1,4	44	08.87 - 07.90	TU3	4		RC-CT601	7371
1,4	50	08.87 - 07.92	TU3A	4		RC-CT601	7371
1,4	52	02.83 - 07.87	XY6B	4		RC-PG604	7374
1,4	55	08.87 - 07.98	TU3MC	4		RC-CT615	7285
1,4	55	08.87 - 12.94	TU3M	4	M4 fitment	RC-CT615	7285
1,4	55	08.87 - 12.94	TU3M	4		RC-CT601	7371
1,4	55	08.87 - 07.98	TU3MC	4		RC-CT601	7371
1,4	55	08.92 - 05.97	TU3MC	4	M4 fitment	RC-CT615	7285
1,4	58	02.83 - 07.87	XY8	4		RC-PG604	7374
1,4 GT	58	02.83 - 07.87	XY8	4		RC-PG604	7374
1,4	58	08.92 - 06.96	TU3MC	4		RC-CT601	7371
1,4	62	08.87 - 06.94	TU3S	4		RC-CT601	7371
1,4	62	09.89 - 07.92	TU3S	4	SAE fitment: With Coil lead	RC-CT601	7371



kW

C
y
l

Stock-No.

PEUGEOT**205**

1,6	55	10.85 - 08.88	XU5CP	4		RC-PG604	7374
1,6	58	02.83 - 06.94	XU51C	4		RC-CT411	0591
1,6	58	02.83 - 06.94	XU51C	4		RC-CR604	8485
1,6	58	02.83 - 06.94	XU51C	4		RC-PG601	8182
1,6	65	08.87 - 06.96	XU5M	4		RC-PG617	7275
1,6 GTi	76	02.83 - 07.90	XU5J	4		RC-CT411	0591
1,6 GTi	77	02.83 - 07.90	XU5J1	4		RC-OP402	0772
1,9 GTi	74	05.86 - 07.90	XU9J1	4	DIN fitment	RC-PG615	7176
1,9 GTi	74	05.86 - 07.90	XU9J1	4	SAE fitment	RC-PG603	8495
1,9 CTi	74	08.87 - 07.90	XU9J1	4	DIN fitment: >12.90	RC-PG615	7176
1,9 CTi	74	08.87 - 07.90	XU9J1	4	SAE fitment: 01.91>	RC-PG603	8495
1,9 CTi	77	05.86 - 07.87	XU9J1	4	DIN fitment: >12.90	RC-PG615	7176
1,9 CTi	77	05.86 - 07.87	XU9J1	4	SAE fitment: 01.91>	RC-PG603	8495
1,9 GTi	77	08.87 - 07.90	XU9J1	4	DIN fitment	RC-PG615	7176
1,9 GTi	77	08.87 - 07.90	XU9J1	4	SAE fitment	RC-PG603	8495
1,9 GTi	89	08.88 - 05.97	XU9JAZ	4	DIN fitment: >12.90	RC-PG615	7176
1,9 GTi	89	08.88 - 05.97	XU9JAZ	4	SAE fitment: 01.91>	RC-PG603	8495
1,9 GTi	94	08.88 - 05.97	XU9JA	4		RC-PG615	7176
1,9 GTi	94	08.88 - 05.97	XU9JA	4		RC-PG603	8495

304

1,1	43	09.76 - 08.80	XK5	4		RC-PG406	0842
1,3	48	10.69 - 08.77	XL5	4		RC-PG406	0842
1,3	55	10.69 - 08.77	XL5S	4		RC-PG406	0842

305

1,3	43	10.77 - 10.82	XL5118	4		RC-PG406	0842
1,5	50	03.86 - 08.89	XR5A	4	Long coil lead	RC-PG612	7157
1,5	54	10.77 - 12.84	XR5	4	Long coil lead	RC-PG612	7157
1,5	54	10.77 - 12.88	XR5	4		RC-PG406	0842
1,5	65	10.77 - 10.82	XR5S	4		RC-PG406	0842
1,6	54	11.82 - 12.88	XU5CP	4		RC-PG601	8182
1,6	58	11.82 - 12.88	XU51C	4		RC-CT411	0591
1,6	58	11.82 - 12.88	XU51C	4		RC-PG601	8182
1,6	66	11.82 - 12.88	XU5S	4		RC-PG607	7399
1,6	69	11.82 - 12.88	XU5S	4		RC-PG607	7399
1,9	75	11.82 - 12.88	XU9S	4		RC-CT411	0591
1,9	75	11.82 - 12.88	XU9S	4		RC-PG601	8182

306

1,1	44	04.93 - 04.97	TU1M	4		RC-CT615	7285
1,4	55	04.93 - 04.97	TU3M	4		RC-CT615	7285
1,4	55	06.94 - 02.96	TU3MZ	4		RC-CT615	7285
1,4	55	03.96 - 07.01	TU3JP	4		RC-CT615	7285
1,6	66	04.93 - 10.00	TU5JP (NFZ)	4		RC-CT615	7285
1,8	74	04.93 - 04.99	XU7JP	4		RC-CR601	8471
2,0	89	11.93 - 04.97	XU10J2	4		RC-CR602	8480
2,0	99	05.97 - 10.01	XU10J4R	4		RC-CR602	8480

309

1,1	40	10.85 - 10.91	E1	4	DIN fitment: 10.85>	RC-PG605	7376
1,1	40	10.85 - 10.91	E1	4	SAE fitment: With Coil lead	RC-PG616	7216
1,1	43	10.85 - 08.89	E1A	4		RC-PG605	7376
1,1	43	10.85 - 08.89	E1A	4		RC-PG616	7216
1,1	44	09.89 - 10.93	TU1M	4		RC-CT601	7371
1,3	47	10.85 - 10.91	G1	4		RC-PG605	7376
1,3	47	10.85 - 10.91	G1	4		RC-PG616	7216
1,4	50	08.88 - 10.92	TU3A	4		RC-CT601	7371
1,4	55	05.87 - 10.93	TU3M	4	M4 fitment: Without Coil lead	RC-CT615	7285



kW

C
y
l

Stock-No.

PEUGEOT**309**

1,4	55	05.87 - 10.93	TU3M	4		RC-CT601	7371
1,4	62	08.88 - 08.89	TU3S	4		RC-CT601	7371
1,6 GT	55	05.87 - 08.89	XU5CP	4	DIN fitment	RC-PG601	8182
1,6 GT	55	05.87 - 08.89	XU5CP	4	SAE fitment	RC-CR604	8485
1,6	58	10.85 - 08.89	XU51C	4	SAE fitment	RC-CR604	8485
1,6	58	10.85 - 08.89	XU51C	4	DIN fitment	RC-PG601	8182
1,6	65	09.89 - 10.93	XU5M	4		RC-PG617	7275
1,6	65	09.89 - 10.93	XU5M	4		RC-CR604	8485
1,6	68	10.85 - 10.93	XU52C	4		RC-PG603	8495
1,6 GT	77	10.85 - 08.89	XU5J	4		RC-PG601	8182
1,6	77	02.86 - 08.89	XU5J	4		RC-PG601	8182
1,9	74	05.87 - 08.89	XU9J1	4		RC-PG601	8182
1,9 GT	80	09.88 - 08.89	XU9M	4		RC-PG603	8495
1,9	80	09.89 - 10.93	XU9M	4		RC-PG603	8495
1,9 GTi	89	05.87 - 10.93	XU9JAZ	4		RC-PG615	7176
1,9 GTi	89	05.87 - 10.93	XU9JAZ	4		RC-PG603	8495
1,9 GT	93	05.87 - 08.89	XU9JA	4		RC-PG615	7176
1,9	96	10.85 - 08.89	XU9JA	4		RC-PG615	7176
1,9 GT	96	08.88 - 08.89	XU9JA	4		RC-PG615	7176
1,9 GTi	96	09.89 - 10.93	XU9JA	4		RC-PG615	7176
1,9 GTi	108	09.89 - 10.93	XU9J4	4		RC-PG602	8467
1,9 GTi	118	09.89 - 07.90	XU9J4	4		RC-PG602	8467

405

1,4	47	06.87 - 07.92	TU3	4		RC-CT601	7371
1,6	53	05.88 - 07.92	XU51C	4	SAE fitment	RC-CR604	8485
1,6	53	05.88 - 07.92	XU51C	4	DIN fitment: Chassis No. XU51CTR	RC-PG601	8182
1,6	55	06.87 - 07.92	XU51C	4	SAE fitment	RC-CR604	8485
1,6	55	06.87 - 07.92	XU51C	4	DIN fitment: Chassis No. XU51CTR	RC-PG601	8182
1,6	65	04.88 - 07.92	XU5M	4		RC-CR604	8485
1,6	65	04.88 - 07.92	XU5M	4		RC-CR601	8471
1,6	65	04.88 - 10.96	XU5M	4		RC-PG617	7275
1,6	65	09.88 - 08.90	XU52C	4		RC-CR604	8485
1,6	66	08.92 - 05.97	XU5M	4		RC-CR604	8485
1,6	66	08.92 - 05.97	XU5JP	4		RC-PG617	7275
1,6	68	06.87 - 08.94	XU52C	4		RC-CR604	8485
1,8	74	08.92 - 05.97	XU7JP	4		RC-CR601	8471
1,9	72	06.87 - 07.92	XU9J1	4		RC-PG601	8182
1,9	72	06.87 - 07.92	XU9J1	4		RC-CR604	8485
1,9	77	06.87 - 07.92	XU9J1	4		RC-PG601	8182
1,9	80	06.87 - 07.92	XU9M	4		RC-CT605	7389
1,9	88	06.87 - 07.92	XU9JAZ	4		RC-CT605	7389
1,9	88	06.87 - 07.92	XU9JAZ	4		RC-PG602	8467
1,9	93	06.87 - 07.92	XU9JAZ	4		RC-CT605	7389
1,9 Mi16	108	06.87 - 07.92	XU9J4	4		RC-PG602	8467
1,9 Mi16	116	06.87 - 07.92	XU9J4	4		RC-PG602	8467
2,0	89	08.92 - 05.97	XU10J2	4		RC-CR602	8480
2,0	110	09.94 - 05.97	XU10J2	4		RC-CR602	8480

406

1,6	66	08.95 - 08.00	XU5JP	4		RC-CR601	8471
1,8	66	10.96 - 08.00	XU7JB	4		RC-CR601	8471
1,8	82	08.95 - 08.00	XU7JP4	4	Chassis No XU7JP4	RC-CR601	8471
1,8	82	08.95 - 08.00	XU7JP4	4	Chassis No XU7JP4	RC-PG617	7275
2,0	99	11.96 - 01.99	XU10J4R	4		RC-CR602	8480
2,0 Turbo	104	08.95 - 03.99	XU10J2TE	4		RC-CR602	8480
2,0 Turbo	108	02.96 - 10.04	XU10J2TE	4		RC-CR602	8480



kW

C
y
i

Stock-No.

PEUGEOT**505**

1,8	55	05.79 - 09.85	XM7	4		RC-PG608	7109
1,8	61	05.79 - 09.85	XM7	4		RC-PG608	7109
2,0	72	10.85 - 08.91	XN1A	4		RC-PG608	7109
2,0 GTi	81	05.79 - 09.85	ZEJ	4		RC-RN1306	6045
2,0	81	10.85 - 09.89	ZEJ	4		RC-RN1306	6045
2,2	84	10.85 - 08.89	ZDJL	4		RC-RN1306	6045
2,2 GTi	84	09.89 - 08.91	ZDJL	4		RC-RN1306	6045
2,2	89	09.83 - 12.93	ZDJL	4		RC-RN1306	6045

605

2,0	79	10.90 - 06.94	XU10MZ	4		RC-PG611	7319
2,0	84	08.89 - 06.94	XU102C	4		RC-PG1301	2578
2,0	89	08.89 - 12.90	XU10J2	4		RC-PG1301	2578
2,0	89	01.91 - 08.96	XU10J2	4		RC-CR602	8480
2,0	104	07.92 - 06.94	XU10J2TE	4		RC-CR602	8480
2,0	108	07.94 - 09.99	XU10J2TE	4		RC-CR602	8480
3,0	123	07.94 - 08.97	ZPJUKZ	6		RC-CT412	0592
3,0	140	07.97 - 06.00	ES9J4	6		RC-PG609	7111
3,0	147	07.94 - 06.97	ZPJ4UKZ	6		RC-PG609	7111

806

1,8	74	10.96 - 05.00	XU7JP	4		RC-PG617	7275
2,0	89	08.94 - 05.00	XU10J2	4		RC-CR602	8480
2,0 Turbo	108	08.94 - 02.03	XU10J2TE	4		RC-CR602	8480

Boxer

2,0	80	03.94 - 04.02	XU10J2	4		RC-CR601	8471
2,0	81	12.01 - 06.06	XU10J2	4		RC-CR601	8471

J5

1,8	51	09.81 - 01.94	XM7T	4		RC-PG608	7109
2,0	55	09.87 - 08.90	XN1T	4		RC-PG608	7109
2,0	58	09.81 - 08.90	XN1T	4		RC-PG608	7109
2,0	69	09.90 - 01.94	XN1T	4		RC-PG608	7109

J9

1,6	44	02.80 - 10.91	XC7P	4		RC-PG608	7109
2,0	57	02.80 - 10.91	XN1	4		RC-PG1302	6071

Partner

1,1	44	05.96 - 08.00	TU1M	4		RC-CT615	7285
1,1	44	09.00 - 10.02	TU1JP	4		RC-CT615	7285
1,4	55	05.96 - 10.02	TU3JP	4		RC-CT615	7285
1,8	66	03.97 - 08.00	XU7JB	4		RC-CR601	8471

PLYMOUTH (CHRYSLER)**Grand Voyager**

3,0	100	10.87 - 09.90	EFA	6		RC-CR304	8286
-----	-----	---------------	-----	---	--	----------	------

Voyager

3,0	100	10.87 - 09.90	EFA	6		RC-CR304	8286
3,0	104	10.90 - 10.92	EFA	6		RC-CR304	8286
3,0	112	11.95 - 03.01	EFA	6		RC-CR304	8286

PORSCHE**356**

1,6	44	09.59 - 08.63	6162	4		RC-VW217	0948
1,6 S	55	09.55 - 08.59	6163	4		RC-VW217	0948
1,6 Super 75	55	09.59 - 08.63	6163	4		RC-VW217	0948



kW

C
y
l

Stock-No.

PORSCHE**356**

1,6	55	09.63 - 08.66	61615	4		RC-VW217	0948
1,6 Super 90	66	09.59 - 08.63	6162	4		RC-VW217	0948
1,6 SC	70	09.63 - 08.66	61614	4		RC-VW217	0948

912

1,6	66	05.64 - 08.69	TN	4		RC-VW217	0948
1,6 Targa	66	09.64 - 08.69	TN	4		RC-VW217	0948

914

1,7 Targa	59	10.69 - 09.74	W	4		RC-VW217	0948
1,8 Targa	63	08.72 - 08.75	AN	4		RC-VW217	0948
2,0 Targa	74	08.71 - 08.75	GB	4		RC-VW217	0948

924

2,0	92	08.75 - 07.85	XJ / XK	4		RC-PS1101	2583
2,0 Turbo	125	08.78 - 07.80	M3101	4		RC-PS1103	6316
2,0 Turbo	130	08.80 - 07.85	M3103	4		RC-PS1101	2583
2,5	120	10.81 - 12.84	M 44.01 / M 44.03	4		RC-PS1103	6316

944

2,5	110	08.83 - 07.85	M4404	4		RC-PS1102	6309
2,5	110	08.83 - 07.85	M4402	4		RC-PS1102	6309
2,5	110	08.85 - 07.87	M4408	4		RC-PS1102	6309
2,5	110	08.85 - 07.87	M4407	4		RC-PS1102	6309
2,5	118	08.87 - 07.89	M4409	4		RC-PS1102	6309
2,5	118	08.87 - 07.89	M4410	4		RC-PS1102	6309
2,5	120	08.81 - 07.85	M4403	4		RC-PS1102	6309
2,5	120	08.81 - 07.85	M4401	4		RC-PS1102	6309
2,5	120	08.85 - 07.87	M4405	4		RC-PS1102	6309
2,5	120	08.85 - 07.87	M4406	4		RC-PS1102	6309
2,5 Turbo	162	08.85 - 07.86	M4450	4		RC-PS1102	6309
2,5 Turbo	162	08.85 - 07.88	M4451	4		RC-PS1102	6309
2,5 Turbo S	184	08.87 - 07.91	M4452	4		RC-PS1102	6309
2,7	121	08.88 - 07.90	M4462	4		RC-PS1102	6309
2,7	121	08.88 - 07.90	M4461	4		RC-PS1102	6309

PROTON**Persona**

1,3 313	55	03.96 - 12.02	G13B	4		RC-MX1202	7700
1,5 315	66	11.93 - 07.00	G15B	4		RC-MX1202	7700
1,3 413	55	11.93 - 07.00	4G13M	4		RC-MX1202	7700
1,5 415	66	11.93 - 07.00	4G15M	4		RC-MX1202	7700

Satira









1,3	55	03.96 -	G13B	4		RC-MX1202	7700
1,5	64	09.96 -	G15B	4		RC-MX1202	7700
1,5	64	08.00 -	4G15M	4		RC-MX1202	7700

Wira

1,3	55	01.94 -	4G13	4		RC-MX1202	7700
1,5	66	01.94 -	4G15	4		RC-MX1202	7700

PUCH**G-Modell**

5,0 G 500	218	04.98 -	M113.962	8		RC-MB1103	7800
-----------	-----	---------	----------	---	--	-----------	------

							
RELIANT							
Kitten							
0,8	29	10.76 - 04.83	H92	4		RC-RN409	0860
Rebel							
0,7	19	08.71 - 02.75	77L	4		RC-RN409	0860
0,7	24	08.71 - 02.75	77L	4		RC-RN409	0860
Rialto							
0,8	29	10.81 - 03.91	85H	4		RC-RN409	0860
Robin							
0,8	29	05.75 - 10.88	H92	4		RC-RN409	0860
0,8	29	11.88 - 10.93	H92N	4		RC-RN409	0860
Scimitar							
1,3	49	03.85 - 10.87	H12V	4		RC-FD509	0604
1,4	53	11.87 - 12.89	ZH14I	4		RC-FD509	0604
1,4	53	01.90 - 04.92	ZH14I	4		RC-FD537	0632
1,4		01.93 - 12.95	K16	4		RC-RV413	0888
1,6	71	03.85 - 12.89	ZH16I	4		RC-FD509	0604
RENAULT							
4							
0,8	21	08.82 - 08.86	800707	4		RC-RN1302	2587
1,1	25	06.76 - 12.92	688712	4		RC-RN639	7375
1,1 GTL	33	02.78 - 03.84	688712	4		RC-RN639	7375
5							
0,8	25	10.72 - 03.85	800 702 / - 710	4		RC-RN1302	2587
1,0	30	04.85 - 07.93	C1C700	4		RC-RN640	7379
1,0	32	10.72 - 03.85	689710	4		RC-RN1302	2587
1,1	33	07.79 - 03.85	688713	4		RC-RN1302	2587
1,1	33	04.85 - 06.89	C1E 750 / - 752	4		RC-RN620	8487
1,1	33	04.85 - 01.92	C1E 750 / 752 / 756 / 760	4		RC-RN640	7379
1,1	34	04.85 - 09.89	C1E750	4		RC-FT638	7291
1,2	40	07.87 - 09.89	C1G720	4		RC-RN640	7379
1,3 GTL	31	07.76 - 06.79	810726	4		RC-RN1302	2587
1,3 GTL	33	07.79 - 03.85	810719	4		RC-RN1302	2587
1,3	40	07.76 - 03.85	810729	4		RC-RN1302	2587
1,3 TS	47	03.74 - 03.85	810725	4		RC-RN1302	2587
1,4	43	07.79 - 03.85	847712	4		RC-RN1302	2587
1,4	43	04.85 - 01.92	C1J768 / C2J784	4	SAE fitment: With Coil lead	RC-RN620	8487
1,4	43	07.89 - 01.92	C2J784	4	DIN fitment	RC-RN640	7379
1,4 Five	44	07.89 - 08.94	C3J760 / C3J702	4		RC-RN620	8487
1,4 TS	46	07.79 - 03.85	C2J713	4		RC-RN1302	2587
1,4 TS	49	07.87 - 06.89	C2J782	4		RC-RN620	8487
1,4	50	07.87 - 06.89	C2J700	4		RC-RN620	8487
1,4	52	04.85 - 06.89	C2J789	4		RC-RN620	8487
1,4	68	02.76 - 03.85	840725	4		RC-RN1302	2587
1,4 Turbo	79	04.82 - 10.83	840726	4		RC-RN1302	2587
1,4 Turbo	81	11.83 - 03.85	C6J750	4		RC-RN1302	2587
1,4 Turbo	85	04.85 - 01.92	C1J782 / C1J788	4		RC-RN620	8487
1,4 Turbo	85	04.85 - 01.92	C1J782 / C1J788	4	1000mm Coil lead	RC-RN648	7153
1,4 Turbo	85	08.85 - 09.89	C1J788	4		RC-RN637	7368
1,4 Turbo	118	09.80 - 03.85	840730	4		RC-RN1302	2587
1,7	54	02.87 - 01.92	F3N 716 / 717	4		RC-RN629	8507



kW

C
y
l

Stock-No.

RENAULT

5							
1,7	66	07.87 - 01.92	F2N740 / F3N702	4		RC-RN629	8507
6							
1,1	33	08.70 - 04.87		4		RC-RN639	7375
9							
1,1	35	03.82 - 06.86	C1E715	4		RC-RN640	7379
1,2	40	07.86 - 04.89	C1G 700 / - 710	4		RC-RN640	7379
1,4	44	04.82 - 06.86	C1J715	4	1000mm Coil lead	RC-RN648	7153
1,4	44	02.84 - 06.86	C1J715	4		RC-RN640	7379
1,4	44	07.86 - 04.89	C2J730	4	1000mm Coil lead	RC-RN648	7153
1,4	44	07.86 - 04.89	C2J730	4		RC-RN640	7379
1,4	50	04.82 - 06.86	C2J718 / C2J766	4	1000mm Coil lead	RC-RN648	7153
1,4	50	04.82 - 06.86	C2J718 / C2J766	4		RC-RN640	7379
1,4	53	04.82 - 06.84	C2J717	4	1000mm Coil lead	RC-RN648	7153
1,4	53	04.82 - 06.84	C2J717	4		RC-RN640	7379
1,4 Turbo	77	04.84 - 06.86	C1J760	4	1000mm Coil lead	RC-RN648	7153
1,4 Turbo	85	07.86 - 04.89	C1J764	4	1000mm Coil lead	RC-RN648	7153
1,4 Turbo	87	07.86 - 04.89	C1J764	4	1000mm Coil lead	RC-RN648	7153
1,7	54	07.86 - 08.88	F2N730	4		RC-VL616	7172
1,7	60	03.84 - 06.86	F2N704	4		RC-VL616	7172
1,7	60	03.84 - 06.86	F2N700	4		RC-VL616	7172
1,7	66	07.86 - 04.89	F2N708	4		RC-VL616	7172
1,7	70	07.86 - 04.89	F3N708	4		RC-VL616	7172
11							
1,1	35	04.82 - 06.86	C1E715	4		RC-RN640	7379
1,2	40	07.86 - 04.89	C1G710	4		RC-RN640	7379
1,4	44	04.82 - 06.86	C1J715	4		RC-RN640	7379
1,4	44	07.86 - 04.89	C2J730	4	1000mm Coil lead	RC-RN648	7153
1,4	44	07.86 - 04.89	C2J730	4		RC-RN640	7379
1,4	50	04.82 - 06.86	C2J717	4	1000mm Coil lead	RC-RN648	7153
1,4	50	04.82 - 06.86	C2J718	4	1000mm Coil lead	RC-RN648	7153
1,4	50	04.82 - 06.86	C2J717	4		RC-RN640	7379
1,4	50	04.82 - 06.86	C2J718	4		RC-RN640	7379
1,4	50	07.86 - 04.89	C2J767	4	1000mm Coil lead	RC-RN648	7153
1,4	50	07.86 - 04.89	C2J768	4	1000mm Coil lead	RC-RN648	7153
1,4	50	07.86 - 04.89	C2J768	4		RC-RN640	7379
1,4	50	07.86 - 04.89	C2J767	4		RC-RN640	7379
1,4 Turbo	77	02.84 - 06.86	C1J760	4		RC-RN648	7153
1,4 Turbo	85	08.83 - 06.86	C1J760	4		RC-RN648	7153
1,7	54	07.86 - 08.88	F2N730	4		RC-VL616	7172
1,7	55	07.86 - 04.89	F3N718	4		RC-VL616	7172
1,7	60	04.82 - 06.86	F2N704	4		RC-VL616	7172
1,7	66	06.84 - 04.89	F2N708	4		RC-VL616	7172
12							
1,3	40	08.75 - 07.77	81002A	4		RC-RN1302	2587
1,3	40	08.77 - 06.80	81002B	4		RC-RN1302	2587
1,3	43	02.73 - 06.80	81005	4		RC-RN1302	2587
1,3	45	08.75 - 06.80	81006	4		RC-RN1302	2587
16							
1,6	52	07.71 - 06.80	84101	4		RC-RN1302	2587
1,6	61	09.67 - 05.71	80703	4		RC-RN1201	6981
1,6	61	06.71 - 06.76	80705	4		RC-RN1201	6981



kW

C
y
l

Stock-No.

RENAULT**16**

1.6	61	06.71 - 06.76	80704	4		RC-RN1201	6981
-----	----	---------------	-------	---	--	-----------	------

17

1.6	63	03.72 - 04.76	80710	4		RC-RN1305	6024
-----	----	---------------	-------	---	--	-----------	------

18

1.4	46	04.78 - 09.86	847720	4		RC-RN640	7379
1.6	52	05.84 - 09.86	A2M723	4		RC-RN640	7379
1.6	54	03.83 - 09.86	841717	4		RC-RN640	7379
1.6	58	04.78 - 04.84	841725	4		RC-RN640	7379
1.6	58	04.78 - 06.81	841726	4		RC-RN640	7379
1.6	70	07.81 - 04.84	A6M725	4		RC-RN640	7379
1.6 Turbo	81	07.81 - 08.82	807727	4		RC-RN640	7379
1.6 Turbo	81	07.81 - 08.82	807727	4		RC-RN1305	6024
1.6 Turbo	82	03.83 - 09.86	A7L752	4		RC-RN640	7379
1.6	82	10.83 - 09.86	A7L752	4		RC-RN640	7379
1.6 Turbo E	92	09.82 - 09.86	A5L717	4		RC-RN640	7379
1.6 Turbo E	92	03.83 - 09.86	A5L718	4		RC-RN640	7379
2.0	77	07.81 - 09.86	J6R716	4		RC-RN619	8470
2.0	77	07.81 - 09.86	J6R716	4		RC-RN1306	6045

19

1.4	43	07.88 - 11.89	C2J772	4		RC-RN637	7368
1.4	43	07.88 - 08.93	C1J742	4		RC-RN637	7368
1.4	44	07.88 - 09.94	C3J710	4		RC-RN637	7368
1.4	55	09.90 - 09.94	E7J700	4		RC-RN637	7368
1.4	57	07.88 - 11.95	E6J700	4		RC-RN637	7368
1.4	57	07.88 - 04.92	E6J701	4		RC-RN637	7368
1.4	59	05.92 - 11.95	E7J706	4		RC-RN637	7368
1.7	55	07.88 - 04.92	F2N728	4		RC-VL607	8472
1.7	55	09.90 - 11.95	F3N741	4		RC-VL607	8472
1.7	55	09.90 - 11.95	F3N740	4		RC-VL607	8472
1.7	55	02.91 - 04.92	F3N742	4		RC-VL607	8472
1.7	66	07.88 - 09.94	F3N742	4		RC-VL607	8472
1.7	66	07.88 - 02.97	F3N743	4		RC-VL607	8472
1.7	70	02.91 - 04.92	F3N743	4		RC-VL607	8472
1.7	79	06.89 - 09.94	F3N746	4		RC-VL607	8472
1.8	65	03.93 - 02.97	F3P705	4		RC-RN655	7190
1.8	66	05.92 - 09.94	F3P706	4		RC-RN655	7190
1.8	66	03.93 - 02.97	F3P760	4		RC-RN655	7190
1.8	66	03.95 - 11.95	F3P765	4		RC-RN655	7190
1.8	67	05.92 - 09.94	F3P765	4		RC-RN655	7190
1.8	79	09.94 - 11.95	F3P706	4		RC-RN655	7190
1.8	79	10.91 - 02.97	F3P760	4		RC-RN655	7190
1.8	79	04.95 - 02.97	F3P765	4		RC-RN655	7190
1.8	81	05.92 - 09.94	F3P682	4		RC-RN655	7190
1.8	99	02.90 - 02.97	F7P704	4		RC-RN645	7108
1.8	101	02.91 - 04.94	F7P704	4		RC-RN645	7108

20

1.6	66	08.75 - 06.80	84 320 / -321	4		RC-RN1305	6024
1.6	71	07.80 - 12.81	843720	4		RC-RN1305	6024
2.0	77	07.80 - 09.84	829703	4		RC-RN1306	6045
2.0	77	07.80 - 09.84	829702	4		RC-RN1306	6045
2.0	80	07.80 - 12.81	829700	4		RC-RN1306	6045
2.0	80	07.80 - 12.81	829701	4		RC-RN1306	6045
2.2	85	08.80 - 09.85	851700	4		RC-RN1306	6045



kW

C
y
i

Stock-No.

RENAULT**21**

1,7 GTL	54	06.88 - 06.89	F2N750	4		RC-RN629	8507
1,7	55	07.89 - 05.93	F3N726	4		RC-RN627	8505
1,7	55	06.86 - 06.93	F2N712	4		RC-RN629	8507
1,7	65	04.86 - 08.92	F2N 711 / - 711	4		RC-RN629	8507
1,7	66	06.86 - 06.93	F3N723	4		RC-RN627	8505
1,7	69	04.86 - 09.95	F3N722	4		RC-RN627	8505
1,7	70	04.86 - 06.89	F3N723	4		RC-RN627	8505
2,0	75	06.91 - 05.93	J7R746	4		RC-RN629	8507
2,0	76	04.88 - 08.92	J6R792	4		RC-RN619	8470
2,0	76	04.88 - 08.92	J6R793	4		RC-RN619	8470
2,0	78	05.91 - 10.93	J6R792	4		RC-RN619	8470
2,0	86	04.86 - 06.92	J7R750	4		RC-RN619	8470
2,0	86	06.86 - 06.92	J7R751	4		RC-RN619	8470
2,0	88	08.89 - 10.94	J7R746	4		RC-RN629	8507
2,0	88	06.91 - 10.94	J7R747	4		RC-RN629	8507
2,0	99	08.89 - 08.92	J7R740	4		RC-RN629	8507
2,0	100	07.89 - 09.95	J7R740	4		RC-RN629	8507
2,0 Turbo	121	08.89 - 06.93	J7R756	4		RC-RN629	8507
2,0 Turbo	129	04.86 - 06.89	J7R752	4		RC-RN619	8470
2,0 Turbo	129	06.87 - 06.89	J7R752	4		RC-RN1307	6070
2,2	79	04.86 - 09.95	J7T754	4		RC-RN619	8470
2,2	81	04.86 - 09.95	J7T755	4		RC-RN619	8470

25

2,0	73	05.84 - 05.88	J6R707	4		RC-RN619	8470
2,0	74	05.84 - 07.90	J6R 706 / - 707	4		RC-RN619	8470
2,0	100	06.90 - 03.92	J7R726	4		RC-RN629	8507
2,0	103	06.88 - 03.92	J7R721	4		RC-RN629	8507
2,2	79	06.88 - 11.91	J7T732	4		RC-RN619	8470
2,2	81	05.84 - 11.91	J7T 708 / - 730 / - 733	4		RC-RN619	8470
2,2	89	05.84 - 05.88	J7T 706 / - 707 / - 730	4		RC-RN619	8470
2,2	91	06.88 - 03.92	J7T730	4		RC-RN619	8470
2,5 Turbo	133	03.85 - 02.90	Z7U702	6		RC-RN1301	2586
2,5 Turbo	151	06.89 - 03.92	Z7U700	6		RC-RN1301	2586
2,7	104	05.84 - 05.88	Z7J 708 / - 709 / - 711	6		RC-RN650	7167
2,8	100	02.87 - 05.88	Z7W702	6		RC-RN653	7183
2,8	110	02.87 - 03.92	Z7W 706 / - 707	6		RC-RN653	7183
2,8	115	06.88 - 02.90	Z7W700	6		RC-RN653	7183

Clio

1,1	35	05.90 - 05.95	C1E700	4		RC-RN640	7379
1,1	43	09.98 - 09.99	D7F22	4		RC-RN603	8185
1,1	43	10.99 -	D7F22	4		RC-RN1204	6794
1,2 RN	40	08.90 - 02.98	E5F706 / E7F706	4		RC-RN637	7368
1,2	40	06.94 - 04.96	C3G720	4		RC-RN620	8487
1,2	40	05.96 - 02.98	D7F730	4		RC-RN637	7368
1,2	43	05.90 - 09.98	E7F	4		RC-RN637	7368
1,2	43	09.98 -	D7F	4		RC-RN1204	6794
1,2 RN	43	02.98 - 05.01	D7F726	4		RC-RN603	8185
1,2 RT	43	07.98 - 03.00	D7F726	4		RC-RN603	8185



kW

C
y
l

Stock-No.

RENAULT**Clio**

1,2 Advantage	43	03.99 - 05.01	D7F726	4		RC-RN603	8185
1,2 RT	43	03.99 - 05.01	D7F744	4		RC-RN603	8185
1,2 Liberte	43	04.00 - 05.01	D7F726	4		RC-RN603	8185
1,2 RN	43	05.00 - 10.03	D4D700	4		RC-RN603	8185
1,2 MTV	43	07.00 - 05.01	D7F726	4		RC-RN603	8185
1,2 Expression	43	06.01 - 08.01	D7F726	4		RC-RN603	8185
1,2 Authentique	43	09.01 - 06.04	D7F726	4		RC-RN603	8185
1,2 Authentique Comfort	43	06.03 -	D7F726	4		RC-RN603	8185
1,2	43	11.03 -	D7F746	4		RC-RN603	8185
1,2 Authentique Basic	43	11.03 -	D7F726	4		RC-RN603	8185
1,2 Expression Comfort	43	03.04 -	D7F726	4		RC-RN603	8185
1,2 Authentique	43	04.04 -	D4D706	4		RC-RN603	8185
1,2 Dynamique Luxe	43	04.04 -	D7F726	4		RC-RN603	8185
1,2 Authentique Luxe	43	08.04 -	D4D752	4		RC-RN603	8185
1,2 RL Prima	44	05.90 - 05.94	E7F700	4		RC-RN637	7368
1,2 RL	44	05.90 - 05.94	E5F710	4		RC-RN637	7368
1,2 RN	44	03.91 - 05.94	E5F710	4		RC-RN637	7368
1,2 RL	44	06.91 - 05.94	E7F700	4		RC-RN637	7368
1,2	44	06.93 - 05.94	E7F700	4		RC-RN637	7368
1,2 Campus	44	10.93 - 05.94	E7F700	4		RC-RN637	7368
1,2 RC	44	06.94 - 02.98	E7F708	4		RC-RN637	7368
1,2 RN	44	06.94 - 04.96	E7F700	4		RC-RN637	7368
1,2 RL	44	06.94 - 02.98	E7F750	4		RC-RN637	7368
1,2 RN	44	06.94 - 02.98	E7F708	4		RC-RN637	7368
1,2 Versailles	44	09.95 - 02.98	E7F708	4		RC-RN637	7368
1,2	44	05.96 - 02.98	E7F708	4		RC-RN637	7368
1,2 Campus	44	05.96 - 02.98	D7F730	4		RC-RN637	7368
1,2	44	03.98 - 10.01	D7F720	4		RC-RN603	8185
1,2	44	03.98 - 10.01	D7F722	4		RC-RN603	8185
1,2 RT	44	03.98 - 02.99	D7F720	4		RC-RN603	8185
1,2	44	03.99 - 01.00	D7F722	4	>12.99	RC-RN603	8185
1,2 RTA	44	03.99 - 05.01	D7F722	4		RC-RN603	8185
1,2 Sport	44	04.00 - 05.01	D7F746	4		RC-RN603	8185
1,2	48	06.05 -	D4F740	4		RC-RN1311	44278
1,2	54	11.12 -	D4F740	4		RC-RN1311	44278
1,2	55	06.01 - 05.07	D4F714	4		RC-RN1311	44278
1,2	55	06.07 -	D4F714	4		RC-FT1209	4746
1,2	55	07.08 -	D4F740	4		RC-RN1311	44278
1,2	58	06.05 -	D4F764	4		RC-RN1311	44278
1,2	74	02.08 -	D4F784	4		RC-RN1205	44338
1,4 RL	55	05.90 - 04.96	E7J719	4		RC-RN637	7368
1,4 RN	55	05.90 - 04.96	E7J718	4		RC-RN637	7368
1,4	55	06.94 - 04.96	E7J719	4		RC-RN637	7368
1,4	55	06.94 - 04.96	E7J718	4		RC-RN637	7368
1,4 RT	55	06.94 - 04.96	E7J754	4		RC-RN637	7368
1,4	55	07.98 - 03.05	E7J780	4		RC-RN1203	4081
1,4 MTV	55	07.00 - 05.01	E7J634	4		RC-RN1203	4081
1,4 RN	57	05.90 - 04.96	E6J713	4		RC-RN637	7368
1,4 RT	57	05.90 - 04.96	E7J710	4		RC-RN637	7368
1,4 RT	57	05.90 - 04.96	E7J711	4		RC-RN637	7368
1,4 S	57	05.90 - 04.96	E6J712	4		RC-RN637	7368
1,4 RN	57	08.90 - 04.96	E6J712	4		RC-RN637	7368
1,4 Baccara	57	02.91 - 05.94	E7J710	4		RC-RN637	7368
1,4 Baccara	57	02.91 - 05.94	E7J711	4		RC-RN637	7368
1,4	57	02.92 - 05.94	E7J710	4		RC-RN637	7368
1,4 Club Med	57	06.94 - 04.96	E7J710	4		RC-RN637	7368
1,4 RL	57	06.94 - 04.96	E6J713	4		RC-RN637	7368



kW

C
y
l

Stock-No.

RENAULT**Clio**

1,4	57	06.94 - 04.96	E7J711	4		RC-RN637	7368
1,4 RT	57	06.94 - 04.96	E6J712	4		RC-RN637	7368
1,4	57	05.96 - 02.98	E6J760	4		RC-RN637	7368
1,6	66	03.98 - 05.01	K7M746	4		RC-RN1203	4081
1,6 RX	66	03.98 - 05.01	K7M700	4		RC-RN1203	4081
1,6 RXE	66	03.98 - 01.00	K7M745	4		RC-RN1203	4081
1,6 RXT	66	03.98 - 01.00	K7M744	4		RC-RN1203	4081
1,6 RT	66	07.98 - 01.00	K7M745	4		RC-RN1203	4081
1,6	66	03.99 - 01.00	K7M745	4		RC-RN1203	4081
1,6 RTXE	66	03.99 - 01.00	K7M744	4		RC-RN1203	4081
1,7 RT	65	01.98 - 09.98	F3P710/714	4		RC-RN655	7190
1,7 RT	66	08.94 - 09.98	F3P754/755	4		RC-RN655	7190
1,8 RT	70	05.90 - 05.94	F3P710	4		RC-RN655	7190
1,8 Baccara	70	06.94 - 02.98	F3P710	4		RC-RN655	7190
1,8 RSi	80	12.93 - 02.98	F3P758	4		RC-RN655	7190
1,8 RSi	81	05.90 - 04.96	F3P712	4		RC-RN655	7190
1,8 16S	99	05.90 - 04.96	F7P722	4		RC-RN645	7108
1,8 16S	100	02.91 - 10.92	F7P720	4		RC-RN645	7108
2,0	108	03.93 - 04.96	F7R700	4		RC-RN645	7108
2,0	124	02.00 -	F4R730	4		RC-RN1308	44225
2,0	132	01.04 -	F4R738	4		RC-RN1308	44225

Espace

2,0	74	06.85 - 12.90	J6R734	4		RC-RN619	8470
2,0	76	01.91 - 10.96	J7R768	4		RC-RN619	8470
2,0	80	07.84 - 12.90	J6R236	4		RC-RN619	8470
2,0	78	06.84 - 12.87	J6R234	4		RC-RN619	8470
2,0	83	11.96 - 09.97	F3R729	4		RC-RN601	8183
2,0	83	11.96 - 09.97	F3R728	4		RC-RN601	8183
2,0	83	11.96 - 04.98	F3R742	4		RC-RN601	8183
2,0	84	10.97 - 01.00	F3R768	4		RC-RN601	8183
2,0	84	10.97 - 01.00	F3R769	4		RC-RN601	8183
2,0	87	06.85 - 12.90	J7R760	4		RC-RN619	8470
2,2 RN	79	01.91 - 10.96	J7T772	4		RC-RN619	8470
2,2 RL	79	06.92 - 10.96	J7T772	4		RC-RN619	8470
2,2 RXE	79	05.93 - 10.96	J7T772	4		RC-RN619	8470
2,2 TSE	81	06.86 - 12.87	J7T770	4		RC-RN619	8470
2,2 2000-1 TXE	81	06.87 - 12.90	J7T770	4		RC-RN619	8470
2,2 2000-1 GTS	81	01.88 - 12.90	J7T770	4		RC-RN619	8470
2,2 2000 GTX	81	06.89 - 12.90	J7T770	4		RC-RN619	8470
2,8 RT	110	01.91 - 10.96	Z7W712	6		RC-RN653	7183
2,8 RT	110	06.92 - 10.96	Z7W713	6		RC-RN653	7183
3,0 Elysee	124	11.96 - 05.98	Z7X775	6		RC-RN602	8184
3,0 RXE	124	04.97 - 10.98	Z7X775	6		RC-RN602	8184

Express

1,0	27	02.86 - 05.92	C1C706	4		RC-RN637	7368
1,0	27	02.86 - 05.92		4		RC-RN640	7379
1,0	27	02.86 - 05.92		4		RC-RN620	8487
1,0	31	09.85 - 08.91	C1C706	4		RC-RN637	7368
1,1 GTC	34	09.85 - 08.91	C1E750	4	SAE fitment: With Coil lead	RC-RN620	8487
1,1 GTC	34	09.85 - 08.91	C1E750	4	DIN fitment	RC-RN640	7379
1,1 GTC	34	10.87 - 08.91	C1E756	4	SAE fitment: With Coil lead	RC-RN620	8487
1,1 GTC	34	10.87 - 08.91	C1E756	4	DIN fitment	RC-RN640	7379
1,1 GTC	35	09.91 - 08.93	C1E762	4	SAE fitment: With Coil lead	RC-RN620	8487
1,1 GTC	35	09.91 - 08.93	C1E762	4	DIN fitment	RC-RN640	7379
1,1 L	35	09.93 - 04.95	C1E762	4	SAE fitment: With Coil lead	RC-RN620	8487
1,1 RL	35	09.93 - 04.95	C1E762	4	DIN fitment	RC-RN640	7379
1,2	40	05.95 - 11.98	C3G710	4	>10.97	RC-RN620	8487



kW

C
y
l

Stock-No.

RENAULT**Express**

1,2 RN	40	05.95 - 11.98	C3G712	4	>10.97	RC-RN620	8487
1,4 GTL	43	09.85 - 03.98	C1J768/762	4	SAE fitment: With Coil lead	RC-RN620	8487
1,4 GTL	43	09.85 - 03.98	C1J768/762	4	DIN fitment	RC-RN640	7379
1,4 GTL	43	08.88 - 03.98	C1J768/762	4		RC-RN637	7368
1,4 RL	58	09.91 - 08.93	E7J72-	4		RC-RN637	7368
1,4 L	58	09.93 - 03.98	E7J72-	4		RC-RN637	7368

Extra

1,1 GTC	34	09.85 - 08.91	C1E750	4	SAE fitment: With Coil lead	RC-RN620	8487
1,1 GTC	34	09.85 - 08.91	C1E750	4	DIN fitment	RC-RN640	7379
1,1 GTC	35	09.91 - 08.93	C1E762	4	SAE fitment: With Coil lead	RC-RN620	8487
1,1 GTC	35	09.91 - 08.93	C1E762	4	DIN fitment	RC-RN640	7379
1,4 GTL	43	09.85 - 12.91	C1J768	4	SAE fitment: With Coil lead	RC-RN620	8487
1,4 GTL	43	09.85 - 12.91	C1J768	4	DIN fitment	RC-RN640	7379
1,4 GTL	44	09.85 - 12.91	C3J700	4		RC-RN637	7368
1,4 GTL	44	10.90 - 12.91	C3J762	4		RC-RN637	7368
1,4 TL	58	09.93 - 05.95	E7J724	4		RC-RN637	7368

Fuego

1,4 GTL	46	02.80 - 10.86	847720	4		RC-RN640	7379
1,6 GTL	52	04.83 - 10.86	A2M723	4		RC-RN1305	6024
1,6 TS	69	02.80 - 10.86	A6M726	4		RC-RN1305	6024
1,6 GTS	71	02.80 - 10.86	A6M725	4		RC-RN1305	6024
1,6 Turbo	97	10.83 - 10.86	A5L750	4		RC-RN1305	6024
2,0 GTX	79	10.81 - 10.86	J6R711	4		RC-RN619	8470
2,0	81	10.81 - 10.86	829710	4		RC-RN1306	6045

Kangoo

1,2	43	06.97 - 09.99	D7F710	4		RC-RN603	8185
1,2	43	08.97 - 09.99	D7F720	4		RC-RN603	8185
1,2	43	10.99 - 06.01	D7F710	4		RC-RN1204	6794
1,2	43	10.99 - 07.01	D7F720	4		RC-RN1204	6794
1,2	55	06.01 -	D4F	4		RC-RN1311	44278
1,4 RT	55	06.97 - 06.01	E7J780	4		RC-RN1203	4081
1,6	64	02.08 -	K7M750	4		RC-RN1202	4053

Laguna

1,6	79	11.97 - 05.95	K4M	4		RC-RN1203	4081
1,8 RXE	66	09.93 - 05.95	F3P720	4		RC-RN623	8493
1,8 RN	66	09.93 - 06.98	F3P724	4	>05.95	RC-RN623	8493
1,8 RN	66	09.93 - 06.98	F3P724	4	05.95>	RC-RN1304	5595
1,8 RT	66	03.94 - 05.95	F3P720	4		RC-RN623	8493
1,8 Evolution	66	06.95 - 06.98	F3P724	4	>05.95	RC-RN1304	5595
1,8 RTE	69	06.95 - 08.99	F3P674	4		RC-RN606	8234
2,0	80	03.99 - 03.01	F3R611	4		RC-RN1304	5595
2,0	80	03.99 - 03.01	F3R611	4	SAE Fitment	RC-RN601	8183
2,0	80	03.99 - 03.01	F3R611	4	M4 Fitment	RC-RN606	8234
2,0	83	09.93 - 06.98	F3R722	4		RC-RN623	8493
2,0	83	09.93 - 06.98	F3R723	4	>05.95	RC-RN623	8493
2,0	83	09.93 - 06.98	F3R722	4	05.95>	RC-RN1304	5595
2,0	83	09.93 - 06.98	F3R723	4	05.95>	RC-RN1304	5595
2,0	83	04.94 - 06.98	F3R723	4		RC-RN623	8493
2,0	83	04.94 - 06.98	F3R722	4	>05.95	RC-RN623	8493
2,0	83	06.95 - 06.98	F3R722	4		RC-RN1304	5595
2,0	83	06.95 - 06.98	F3R723	4		RC-RN1304	5595
2,0	84	06.95 - 06.98	F3R729	4		RC-RN1304	5595
2,0	84	06.95 - 06.98	F3R728	4		RC-RN1304	5595
2,0	103	06.95 - 02.01	N7Q704	4		RC-RN608	8492
2,0	103	06.95 - 06.98	N7Q700	4		RC-RN608	8492
2,0	103	04.01 -	FSR700	4		RC-RN1310	44248



kW

C
y
l

Stock-No.

RENAULT**Laguna**

3,0	123	09.93 - 03.01	Z7X760	6		RC-RN602	8184
3,0	123	06.95 - 03.01	Z7X765	6		RC-RN602	8184

Logan

1,4 X90	55	08.04 -	K7J710	4		RC-RN1202	4053
1,6 X90	64	08.04 -	K7M710	4		RC-RN1202	4053

Master

2,0	59	07.80 - 06.85	829731	4		RC-RN651	7170
2,0	60	07.85 - 12.95	J5R718	4		RC-RN651	7170
2,2	67	07.85 - 02.98	J7T782	4		RC-RN651	7170

Mégane

1,4 RL Eco	52	08.95 - 02.99	E7J624	4		RC-RN637	7368
1,4 RL	55	08.95 - 02.99	E7J764	4		RC-RN637	7368
1,4 RL	55	10.96 - 06.99	E7J764	4	Scenic	RC-RN637	7368
1,4	55	03.99 - 09.00	E7J626	4		RC-RN637	7368
1,4	55	03.99 - 09.00	E7J626	4		RC-RN603	8185
1,4	55	02.00 - 09.00	E7J626	4		RC-RN637	7368
1,6 RN	55	08.95 - 02.99	K7M720	4	SAE fitment: >03.97	RC-RN652	7175
1,6 RL	55	08.95 - 02.99	K7M720	4	M4 fitment: 04.97> 06.98	RC-RN1203	4081
1,6 RL	55	08.95 - 02.99	K7M720	4	M4 fitment: 07.98>	RC-RN1202	4053
1,6 RN	55	10.96 - 06.99	K7M720	4	SAE fitment	RC-RN652	7175
1,6 RT	55	10.96 - 02.99	K7M720	4	SAE fitment: >03.97	RC-RN652	7175
1,6 RT	55	10.96 - 02.99	K7M720	4	M4 fitment: 04.97> 06.98	RC-RN1203	4081
1,6 RN	55	10.96 - 06.99	K7M720	4	M4 fitment: 07.98>	RC-RN1202	4053
1,6 RT	55	10.96 - 02.99	K7M720	4	M4 fitment: 07.98>	RC-RN1202	4053
1,6 RN	66	08.95 - 12.99	K7M703	4	SAE fitment: >03.97	RC-RN652	7175
1,6	66	08.95 - 02.99	K7M703	4	SAE fitment: >03.97	RC-RN652	7175
1,6	66	08.95 - 02.99	K7M702	4	SAE fitment: >03.97	RC-RN652	7175
1,6 RT	66	08.95 - 01.00	K7M702	4	SAE fitment: >03.97	RC-RN652	7175
1,6	66	08.95 - 02.99	K7M703	4	M4 fitment: 04.97> 06.98	RC-RN1203	4081
1,6	66	08.95 - 02.99	K7M702	4	M4 fitment: 04.97> 06.98	RC-RN1203	4081
1,6 RN	66	08.95 - 02.99	K7M702	4	M4 fitment: 04.97> 06.98	RC-RN1203	4081
1,6 RT	66	08.95 - 02.99	K7M703	4	M4 fitment: 04.97> 06.98	RC-RN1203	4081
1,6	66	08.95 - 02.99	K7M702	4	M4 fitment: 07.98>	RC-RN1202	4053
1,6 RN	66	08.95 - 06.99	K7M703	4	M4 fitment: 07.98>	RC-RN1202	4053
1,6 RT	66	08.95 - 01.00	K7M702	4	M4 fitment: 07.98>	RC-RN1202	4053
1,6	66	08.95 - 02.99	K7M703	4	M4 fitment: 07.98>	RC-RN1202	4053
1,6 RTE	66	04.96 - 02.99	K7M702	4	SAE fitment: >03.97	RC-RN652	7175
1,6 RTE	66	04.96 - 02.99	K7M702	4	M4 fitment: 04.97> 06.98	RC-RN1203	4081
1,6 RTE	66	04.96 - 02.99	K7M702	4	M4 fitment: 07.98>	RC-RN1202	4053
1,6 RT	66	10.96 - 06.99	K7M702	4	SAE fitment	RC-RN652	7175
1,6 RXE	66	10.96 - 02.99	K7M702	4	SAE fitment: >03.97	RC-RN652	7175
1,6 RTE	66	10.96 - 02.99	K7M703	4	M4 fitment: 04.97> 06.98	RC-RN1203	4081
1,6 RXE	66	10.96 - 02.99	K7M702	4	M4 fitment: 04.97> 06.98	RC-RN1203	4081
1,6 RN	66	10.96 - 06.99	K7M703	4	M4 fitment: 04.97> 06.98	RC-RN1203	4081
1,6 RT	66	10.96 - 06.99	K7M702	4	M4 fitment: 04.97> 06.98	RC-RN1203	4081
1,6 RXE	66	10.96 - 10.99	K7M702	4	M4 fitment: 07.98>	RC-RN1202	4053
1,6 Expression	66	02.97 - 02.99	K7M702	4	SAE fitment	RC-RN652	7175
1,6 RT	66	02.97 - 01.00	K7M703	4	SAE fitment: >03.97	RC-RN652	7175
1,6 Expression	66	02.97 - 02.99	K7M702	4	M4 fitment: 04.97> 06.98	RC-RN1203	4081
1,6 Expression	66	02.97 - 02.99	K7M702	4	M4 fitment: 07.98>	RC-RN1202	4053
1,6 RT	66	05.97 - 10.99	K7M703	4	SAE fitment	RC-RN652	7175
1,6 Roadster	66	05.97 - 02.99	K7M702	4	SAE fitment	RC-RN652	7175
1,6 RN	66	05.97 - 10.99	K7M702	4	SAE fitment	RC-RN652	7175
1,6	66	05.97 - 02.99	K7M702	4	M4 fitment: 04.97>	RC-RN1203	4081
1,6 RT	66	05.97 - 01.00	K7M702	4	M4 fitment: 04.97>	RC-RN1203	4081



kW

C
y
l

Stock-No.

RENAULT**Mégane**

1,6 RT	66	05.97 - 01.00	K7M703	4	M4 fitment: 04.97>	RC-RN1203	4081
1,6 RT	66	05.97 - 01.00	K7M703	4	M4 fitment: 07.98>	RC-RN1202	4053
1,6 RN	66	03.99 - 01.00	K7M702	4	M4 fitment: 07.98>	RC-RN658	7200
1,6 RT	66	03.99 - 01.00	K7M703	4	M4 fitment: 07.98>	RC-RN658	7200
2,0	80	10.96 - 06.00	F3R750	4		RC-RN601	8183
2,0	80	03.99 - 08.03	F3R751	4		RC-RN606	8234
2,0	84	08.95 - 08.03	F3R751	4		RC-RN606	8234
2,0	84	08.95 - 02.99	F3R750	4		RC-RN601	8183
2,0	84	05.97 - 10.99	F3R750	4	Scenic	RC-RN601	8183
2,0	108	07.96 -	F3R710	4		RC-RN1310	44248

Modus

1,2	48	05.05 - 10.07	D4F740	4		RC-RN1311	44278
1,2	55	12.04 -	D4F740	4		RC-RN1311	44278
1,2	58	04.05 -	D4F764	4		RC-RN1311	44278
1,2	74	05.07 -	D4F784	4		RC-RN1205	44338

Rapid

1,1 GTC	34	09.85 - 08.91	C1E750	4	SAE fitment: With Coil lead	RC-RN620	8487
1,1 GTC	34	09.85 - 08.91	C1E750	4	DIN fitment	RC-RN640	7379
1,1 GTC	34	10.87 - 08.91	C1E756	4	SAE fitment: With Coil lead	RC-RN620	8487
1,1 GTC	34	10.87 - 08.91	C1E756	4	DIN fitment	RC-RN640	7379
1,1 GTC	35	09.91 - 08.93	C1E762	4	DIN fitment	RC-RN640	7379
1,1 GTC	35	09.91 - 08.93	C1E762	4	SAE fitment: With Coil lead	RC-RN620	8487
1,1 RL	35	09.93 - 04.95	C1E762	4	DIN fitment	RC-RN640	7379
1,1 L	35	09.93 - 04.95	C1E762	4	SAE fitment: With Coil lead	RC-RN620	8487
1,4 GTL	43	09.85 - 08.91	C1J768	4	DIN fitment	RC-RN640	7379
1,4 GTL	43	09.85 - 08.91	C1J768	4	SAE fitment: With Coil lead	RC-RN620	8487
1,4 RN	54	09.91 - 08.93	E7J724	4		RC-RN637	7368
1,4 L	58	09.93 - 04.95	E7J724	4		RC-RN637	7368

Safrane

2,0	77	01.92 - 10.96	J7R733	4		RC-RN646	7151
2,0	77	01.92 - 10.96	J7R732	4		RC-RN646	7151
2,0	97	01.92 - 10.96	J7R734	4		RC-RN632	8510
2,0	97	01.92 - 10.96	J7R735	4		RC-RN632	8510
2,0	101	11.96 - 04.00	N7Q710	4		RC-RN608	8492
2,0	101	11.96 - 04.00	N7Q711	4		RC-RN608	8492
2,2 RN Vi	79	01.92 - 10.96	J7T763	4		RC-RN632	8510
2,2 RXE Vi	101	01.92 - 10.96	J7T760	4		RC-RN632	8510
2,2 RXE Vi	101	01.92 - 10.96	J7T761	4		RC-RN632	8510
2,2	101	02.93 - 10.96	J7T760	4		RC-RN632	8510
2,2	101	02.93 - 10.96	J7T761	4		RC-RN632	8510
2,5 RXE	120	11.96 - 04.00	N7U700	5		RC-VL605	8468
2,5	120	11.96 - 04.00	N7U701	5		RC-VL605	8468
3,0 RXE	123	01.92 - 10.96	Z7X722	6		RC-RN649	7154
3,0	123	01.92 - 10.96	Z7X723	6		RC-RN649	7154

Sandero

1,4	55	06.08 -	K7J710	4		RC-RN1202	4053
1,6	64	06.08 -	K7M710	4		RC-RN1202	4053

Thalia

1,2	43	02.98 - 10.03	D7F	4		RC-RN603	8185
1,2	55	02.09 -	D4F728	4		RC-RN1311	44278
1,4	55	08.00 -	K7F	4		RC-RN1202	4053



kW

C
y
l

Stock-No.

RENAULT**Trafic**

1,4	35	07.80 - 02.89	847700	4		RC-RN640	7379
1,4	36	03.89 - 12.91	C1J700	4		RC-RN640	7379
1,7	50	06.86 - 08.94	F1N724	4		RC-RN629	8507
2,0	58	07.80 - 04.85	829720	4		RC-RN651	7170
2,0	60	05.85 - 02.89	J5R716	4		RC-RN611	8253
2,0	60	03.89 - 08.94	J5R726	4		RC-RN611	8253
2,0	63	07.80 - 04.85	829720	4		RC-RN651	7170
2,2	71	03.89 - 04.94	J7T780	4		RC-RN619	8470

Twingo

1,2	40	02.93 - 06.96	C3G700	4		RC-RN620	8487
1,2	40	02.95 - 06.96	C3G702	4		RC-RN620	8487
1,2	40	02.95 - 06.96	C3G704	4		RC-RN620	8487
1,2	40	07.96 - 08.98	D7F700	4		RC-RN603	8185
1,2	40	07.96 - 08.98	D7F701	4		RC-RN603	8185
1,2	40	09.98 - 08.00	D7F703	4		RC-RN603	8185
1,2	40	09.98 - 08.00	D7F706	4		RC-RN603	8185
1,2	43	12.99 -	D7F700	4		RC-RN1204	6794
1,2	43	07.96 - 08.98	D7F701	4		RC-RN603	8185
1,2	43	09.98 - 08.00	D7F702	4		RC-RN603	8185
1,2	43	09.98 - 08.00	D7F703	4		RC-RN603	8185
1,2	43	09.00 -	D7F704	4		RC-RN603	8185
1,2	43	03.07 -	D7F800	4		RC-RN1204	6794
1,2	44	08.04 -	D7F708	4	16V	RC-RN1311	44278
1,2	55	01.01 -	D4F	4	16V	RC-RN1311	44278
1,2	74	03.07 -	D4F784	4		RC-RN1205	44338
1,2	75	02.11 -	D4F780	4		RC-RN1205	44338

RILEY**Elf**

0,8	27	06.59 - 08.69	8F	4		RC-AT405	0543
-----	----	---------------	----	---	--	----------	------

ROVER**25**

1,1	55	01.04 - 05.05	11K4F	4	Semi-Direct	RC-RV1205	7706
1,4	62	07.99 - 12.02	14K4M	4	Semi-Direct; Ch YD471565>	RC-RV1202	7705
1,4	76	07.99 - 12.02	14K4F	4	Semi-Direct; Ch YD471565 >	RC-RV1202	7705
1,4	76	07.99 - 12.02	14K4F	4	> Ch YD471564	RC-RV415	0890
1,6	80	07.99 - 12.02	16K4F	4	Semi-Direct; Ch YD471565>	RC-RV1202	7705
1,6	80	07.99 - 12.02	16K4F	4	> Ch YD471564	RC-RV415	0890
1,8	86	07.99 - 10.02	18K4F	4	Semi-Direct; Ch YD471565>	RC-RV1202	7705
1,8	86	07.99 - 10.02	18K4F	4	> Ch YD471564	RC-RV415	0890
1,8	107	07.99 -	18K4K	4	Semi-Direct	RC-RV1205	7706

45

1,4	76	01.00 -	14K4F	4	Semi-Direct	RC-RV1202	7705
1,6	80	01.00 -	16K4F	4	Semi-Direct	RC-RV1202	7705
1,8	86	01.00 -	18K4F	4	Semi-Direct	RC-RV1202	7705
2,0	110	01.00 -	20K4F	4	Semi-Direct	RC-RV901	7408

75

1,8	88	04.99 -	18K4F	4	Semi-Direct	RC-RV1202	7705
1,8	110	05.03 - 05.05	18K4G	4	Semi-Direct	RC-RV1205	7706
2,0	110	04.99 - 03.03	20K4F	4	Semi-Direct	RC-RV901	7408
2,0	110	02.00 - 03.03	20K4F	6	Semi-Direct	RC-RV901	7408
2,5	130	04.99 - 10.01	25K4F		Semi-Direct	RC-RV901	7408
2,5	130	02.00 -	25K4F	6	Semi-Direct	RC-RV901	7408



kW

C
y
l

Stock-No.

ROVER**111**

1,1	44	04.90 - 12.94	11K2A	4		RC-RV304	8269
1,1	44	11.90 - 04.99	11K2D	4		RC-RV304	8269

114

1,4	55	04.90 - 05.92	14K2A	4		RC-RV304	8269
1,4	55	11.91 - 10.97	14K2D	4		RC-RV304	8269
1,4	66	04.90 - 05.92	14K4D	4		RC-RV413	0888
1,4 GTi	66	06.92 - 12.94	14K4D	4		RC-RV413	0888
1,4	70	04.90 - 05.92	14K4C	4		RC-RV413	0888
1,4 GTi	76	04.90 - 12.96	14K4F	4		RC-RV413	0888
1,4	76	06.92 - 12.94	14K4F	4		RC-RV413	0888

200

1,8	107	03.96 - 06.99	18K4K	4		RC-RV1203	7707
-----	-----	---------------	-------	---	--	-----------	------

211

1,1	44	07.96 - 06.99	11K2D	4		RC-RV414	0889
-----	----	---------------	-------	---	--	----------	------

213

1,3	52	09.84 - 12.89	EV2	4		RC-RV404	0879
-----	----	---------------	-----	---	--	----------	------

214

1,4	55	01.90 - 12.95	14K2A	4		RC-RV412	0887
1,4	55	01.96 - 06.99	14K2F	4		RC-RV414	0889
1,4	66	01.90 - 12.97	14K4D	4		RC-RV413	0888
1,4	70	01.90 - 09.92	14K4C	4		RC-RV413	0888
1,4	76	10.92 - 06.99	14K4F	4		RC-RV413	0888

216

1,6	61	09.84 - 12.89	16HAK	4		RC-RV401	0876
1,6	75	09.84 - 12.89	16HA35	4		RC-RV401	0876
1,6	82	01.90 - 02.96	D16Z2	4		RC-RV603	8496
1,6	82	01.96 - 06.99	16K4F	4		RC-RV415	0890
1,6	82	03.96 - 06.99	16K4F	4		RC-RV604	8499
1,6 Gti	90	01.90 - 12.95	D16A8	4		RC-RV604	8499
1,6 GTi	96	01.90 - 09.92	D16A9	4		RC-RV604	8499
1,6	96	02.92 - 09.92	D16A9	4		RC-RV604	8499

218

1,8	107	01.96 - 06.99	18K4K	4		RC-RV1203	7707
-----	-----	---------------	-------	---	--	-----------	------

220

2,0 GTi	103	10.91 - 09.97	20M4F	4		RC-RV313	8297
2,0 Turbo	147	02.92 - 12.95	20T4F	4		RC-RV302	8267

414

1,4	55	03.96 - 12.97	14K2F	4		RC-RV415	0890
1,4	66	01.90 - 09.92	14K4D	4		RC-RV413	0888
1,4	70	01.90 - 09.92	14K4C	4		RC-RV413	0888
1,4	76	10.92 - 02.96	14K4F	4		RC-RV413	0888
1,4	76	10.92 - 06.99	14K4F	4		RC-RV415	0890

416

1,6	82	10.89 - 02.96	D16Z2	4		RC-RV603	8496
1,6	82	10.94 - 12.99	D16A4	4		RC-RV603	8496
1,6	82	10.94 - 05.01	D16A4	4		RC-RV415	0890
1,6	82	03.96 - 06.99	16K4F2	4		RC-RV415	0890
1,6	83	03.96 - 06.99	D16Y3E	4	Chassis no AD074464 >	RC-RV415	0890
1,6	85	01.90 - 04.95	D17A7	4		RC-RV603	8496
1,6 GTi	90	01.90 - 02.96	D16A8	4		RC-RV604	8499
1,6 GTi	96	01.90 - 08.91	D16A9	4		RC-RV604	8499



kW

C
y
l

Stock-No.

ROVER**420**

2,0	103	10.91 - 06.99	20M4F	4		RC-RV303	8268
2,0	103	10.94 - 06.99	20 TH4	4		RC-RV301	8266
2,0	103	05.95 - 06.99	20 T4H	4		RC-RV301	8266

600

2,0	97	03.97 - 06.99	F20Z1	4		RC-RV1302	5400
2,0 Turbo	147	03.96 - 06.99	20T4G	4	05.96>	RC-RV301	8266
2,0 Turbo	147	03.96 - 06.99	20T4G	4	>04.96	RC-RV318	7366
2,3	116	03.96 - 06.99	H23A3	4		RC-RV1302	5400

618

1,8	85	10.94 - 02.96	F18A3	4		RC-RV1302	5400
1,9	85	03.96 - 06.99	F18A	4		RC-RV1302	5400

620

2,0	85	09.93 - 02.96	F20Z2	4		RC-RV1302	5400
2,0	97	09.93 - 06.99	F20Z1	4		RC-RV1302	5400
2,0 Turbo	147	05.94 - 08.98	20T4G	4	05.96>	RC-RV301	8266
2,0 Turbo	147	05.94 - 08.98	20T4G	4	>04.96	RC-RV318	7366

623

2,3	116	09.93 - 02.96	H23A3	4		RC-RV1302	5400
-----	-----	---------------	-------	---	--	-----------	------

820

2,0	98	11.91 - 09.93	20T4HF	4		RC-RV308	8274
2,0	98	10.93 - 01.96	20TH	4		RC-RV307	8272
2,0 Turbo	120	10.88 - 10.91	20HT	4		RC-RV316	8461
2,0 Turbo	132	10.93 - 10.97	20T4G	4		RC-RV1206	7708
2,0 Turbo	147	10.93 - 01.96	20T4G	4		RC-RV1206	7708

825

2,5	110	07.86 - 10.91	C25A2	6		RC-RV605	7384
2,5	123	07.86 - 09.88	C25A2	6		RC-RV605	7384
2,5	127	07.86 - 09.91	C25A2	6		RC-RV605	7384
2,5	129	02.96 - 10.98	25K4H	6		RC-RV305	8270

827

2,7	124	10.87 - 01.96	C27A2	6		RC-RV605	7384
2,7	124	10.93 - 01.96	C27A1	6		RC-RV605	7384
2,7	127	10.88 - 10.91	C27A2	6		RC-RV605	7384

2600

2,6	95	04.77 - 12.87	12C	6		RC-RV1204	5401
2,6	101	04.77 - 10.84	13C	6		RC-RV1204	5401

3500

3,5	104	04.68 - 03.76	AJ7	8		RC-AR414	0538
3,5	115	04.76 - 09.80	18A	8		RC-AR414	0538
3,5	115	04.76 - 09.80	19A	8		RC-AR414	0538
3,5	117	10.80 - 10.84	10A	8		RC-AR414	0538
3,5	117	10.80 - 10.84	11A	8		RC-AR414	0538
3,5	117	10.80 - 10.84	17A	8		RC-AR414	0538
3,5	117	10.80 - 10.84	18A	8		RC-AR414	0538
3,5	135	04.68 - 03.76	AJ6	8		RC-AR414	0538
3,5	142	01.83 - 12.86	30A	8		RC-AR414	0538

Maestro

1,3	47	10.92 - 09.94	12H	4		RC-AT402	0540
1,3	49	10.92 - 10.94	12HE	4		RC-AT402	0540
1,3	51	10.90 - 10.94	12HE	4		RC-AT402	0540
1,6	59	10.92 - 09.94	16H	4		RC-AT404	0542
1,6	63	10.90 - 10.94	16HE	4		RC-AT404	0542



kW

C
y
l

Stock-No.

ROVER**Metro**

1,0	32	04.90 - 05.92	99HL	4		RC-AT405	0543
1,1	44	04.90 - 05.92	11K2A	4		RC-RV1208	44241
1,1	44	04.90 - 12.94	11K2C	4		RC-RV1208	44241
1,1	44	11.91 - 12.94	11K2D	4		RC-RV1208	44241
1,3	39	04.90 - 05.92	12HS	4		RC-AT405	0543
1,3	44	04.90 - 05.92	12HL	4		RC-AT405	0543
1,4	55	04.90 - 05.92	14K2A	4		RC-RV1208	44241
1,4	55	06.92 - 12.94	14K2C	4		RC-RV1208	44241
1,4	55	06.92 - 12.94	14K2D	4		RC-RV1208	44241
1,4	66	04.90 - 05.92	14K4D	4		RC-RV413	0888
1,4	66	11.91 - 05.92	14K2C	4		RC-RV304	8269
1,4	66	11.91 - 05.92	14K2D	4		RC-RV304	8269
1,4 GTi	66	06.92 - 12.94	14K4D	4		RC-RV413	0888
1,4	70	04.90 - 05.92	14K4C	4		RC-RV413	0888
1,4 GTi	76	04.90 - 05.92	14K4F	4		RC-RV413	0888
1,4	76	06.92 - 12.94	14K4F	4		RC-RV413	0888

Mini

1,0	31	08.90 - 09.92	99H	4		RC-AT405	0543
1,3	34	08.90 - 02.94	12A2A	4		RC-AT405	0543
1,3	39	08.90 - 12.97	12A2D	4		RC-AT405	0543
1,3 Cooper	45	10.92 - 10.96	12A2E	4		RC-AT405	0543
1,3 Cooper	46	10.92 - 10.99	12A2L	4		RC-RV410	0885
1,3 Cooper	46	10.92 - 10.99	12A2L	4		RC-AT405	0543
1,3	46	11.96 - 05.01	12A2L	4		RC-RV410	0885
1,3	46	11.96 - 05.01	12A2L	4		RC-AT405	0543
1,3 Cooper S	63	11.96 - 05.01	12A2L	4		RC-AT405	0543
1,3 John Cooper Special	63	09.99 - 05.01	12A2L	4		RC-AT405	0543

Montego

2,0	75	10.92 - 09.94	20HE	4		RC-AT404	0542
-----	----	---------------	------	---	--	----------	------

Streetwise

1,4	62	08.03 - 05.05	14K4F	4		RC-RV1205	7706
1,4	76	08.03 - 05.05	14K4M	4		RC-RV1205	7706
1,6	80	01.04 - 05.05	16K4F	4		RC-RV1205	7706

SD1

2,6		01.77 - 01.87	12C / 13C	6		RC-RV1204	5401
-----	--	---------------	-----------	---	--	-----------	------

Vanden Plas

3,5	117	10.80 - 02.86	17A	8		RC-AR414	0538
3,5	117	10.80 - 02.86	18A	8		RC-AR414	0538
3,5	143	01.82 - 02.86	30A	8		RC-AR414	0538

SAAB**9-3**

2,0	96	03.98 - 10.00	B204I	4		RC-SB605	8200
2,3	110	03.98 - 02.99	B234I	4		RC-SB605	8200

99

2,0	74	09.74 - 08.85	B20C	4		RC-SB601	8187
-----	----	---------------	------	---	--	----------	------

900

2,0	81	10.89 - 10.93	B201	4		RC-SB601	8187
2,0	92	10.89 - 10.93	B202I	4		RC-SB605	8200
2,0	94	10.87 - 09.89	B202I	4		RC-SB605	8200
2,0	96	11.93 - 05.98	B204I	4		RC-SB605	8200
2,0	98	10.87 - 10.91	B202I	4		RC-SB605	8200
2,0	98	11.93 - 05.98	B206I	4		RC-SB605	8200
2,0	103	10.85 - 09.89	B201S	4		RC-SB601	8187



kW

C
y
l

Stock-No.

SAAB**900**

2,0	103	10.85 - 09.89	B201S	4		RC-SB604	8190
2,0	104	05.91 - 10.93	B202S	4		RC-SB605	8200
2,0	107	09.80 - 03.84	B20T	4		RC-SB406	0896
2,0	107	04.84 - 09.89	B201S	4		RC-SB601	8187
2,0	107	10.86 - 09.89	B201S	4		RC-SB604	8190
2,0	107	05.91 - 10.93	B202S	4		RC-SB605	8200
2,0	118	10.85 - 06.94	B202XL	4		RC-SB605	8200
2,0	125	02.84 - 06.94	B202XL	4		RC-SB605	8200
2,0	129	04.84 - 09.89	B202XL	4		RC-SB605	8200
2,0	136	11.93 - 05.98	B204L	4		RC-SB605	8200
2,1	103	10.89 - 07.92	B212I	4		RC-SB605	8200
2,1	107	10.89 - 07.92	B212I	4		RC-SB605	8200
2,3	110	11.93 - 05.98	B234I	4		RC-SB605	8200
2,5	125	11.93 - 05.98	B258I	6		RC-SB408	0898

9000

2,0	92	10.85 - 09.94	B202I	4		RC-SB604	8190
2,0	96	10.85 - 12.91	B202I	4		RC-SB604	8190
2,0	96	10.94 - 10.98	B204I	4		RC-SB605	8200
2,0	129	10.84 - 12.91	B202L	4		RC-SB605	8200
2,3	110	06.89 - 09.94	B234I	4		RC-SB605	8200
2,3	110	06.89 - 09.94	B234I	4	09.90>	RC-SB604	8190
2,3	125	09.92 - 10.98	B234E	4		RC-SB604	8190
2,3	143	10.90 - 10.94	B234L	4		RC-SB605	8200
2,3	143	10.90 - 10.94	B234L	4		RC-SB604	8190
2,3 Turbo 16	165	09.90 - 10.98	B234R	4		RC-SB605	8200
3,0	155	10.94 - 10.98	B308I	6		RC-SB408	0898

SANTANA**Vitara**

1,6	59	09.91 - 10.95	G16A	4		RC-SE83	8748
-----	----	---------------	------	---	--	---------	------

SEAT**124**

1,2	48	01.70 - 03.74	124A100	4		RC-FT431	0678
1,2	48	04.74 - 10.80	FA12	4		RC-FT431	0678
1,4	55	09.75 - 10.80	FA14	4		RC-FT431	0678

127

0,9	25	04.70 - 05.78	141A30	4		RC-FT431	0678
0,9	36	06.78 - 12.86	127A20	4		RC-FT431	0678
1,0	39	10.72 - 10.75	110F00	4		RC-FT431	0678

128

1,2	48	10.67 - 06.80	124A000	4		RC-FT431	0678
1,4	55	10.73 - 06.78	124B2000	4		RC-FT431	0678
1,4	55	07.77 - 06.80	124B2000	4		RC-FT431	0678

133

0,8	25	04.71 - 01.84	850001	4		RC-FT431	0678
-----	----	---------------	--------	---	--	----------	------

Alhambra

2,0	85	03.96 - 07.00	ADY	4		RC-VW230	0961
2,0	85	08.00 - 03.10	ATM	4		RC-VW249	7015

Altea

1,2	77	04.10 -	CBZB	4		RC-VW1110	44316
1,6	75	03.04 -	BGU	4		RC-VW254	7044
1,6	75	10.06 -	BSE / BSF / CCSA / CMXA	4		RC-VW254	7044



kW

C
y
l

Stock-No.

SEAT

Arosa

1,0	37	02.97 - 09.99	AER	4		RC-ST902	7313
1,0	37	05.97 - 07.00	ALL	4		RC-ST902	7313
1,0	37	10.97 - 07.00	AHT	4		RC-ST902	7313
1,0	37	07.99 - 06.04	ANV	4		RC-VW907	7302
1,0	37	09.99 - 06.04	ALD	4		RC-VW907	7302
1,0	37	03.00 - 06.04	AUC	4		RC-ST901	7303
1,4	44	02.97 - 07.00	AEX	4		RC-ST902	7313
1,4	44	05.97 - 07.00	AKV	4		RC-ST902	7313
1,4	44	12.97 - 08.98	APQ	4		RC-ST902	7313
1,4	44	07.99 - 07.00	ANW	4		RC-ST901	7303
1,4	44	09.99 - 07.00	AKK	4		RC-ST902	7313
1,4	44	03.00 - 07.00	AUD	4		RC-ST902	7313
1,4	74	01.00 - 06.04	AFK/AQQ	4		RC-VW1111	44328
1,4	74	01.00 - 06.04	AUB/ANM	4		RC-VW910	7306

Cordoba

1,0	37	05.99 - 05.01	ANV	4		RC-VW907	7302
1,0	37	05.99 - 09.02	ALD	4		RC-VW907	7302
1,3	40	03.93 - 08.94	2G	4		RC-VW216	0947
1,4	44	10.93 - 06.96	ABD	4		RC-VW210	0941
1,4	44	05.97 - 11.97	AEX	4		RC-VW210	0941
1,4	44	12.97 - 04.99	APQ	4		RC-VW210	0941
1,4	44	12.97 - 04.99	AKV/ANX	4		RC-VW210	0941
1,4	44	05.99 - 09.02	ANW/AUD	4		RC-ST901	7303
1,4	44	05.99 - 09.02	AKK	4		RC-ST902	7313
1,4	55	05.99 - 09.02	APE	4		RC-VW910	7306
1,4	74	06.97 - 04.99	AFH	4		RC-VW232	0963
1,4	74	02.00 - 10.02	AQQ	4		RC-VW1111	44328
1,6	55	10.93 - 06.96	ABU	4		RC-VW215	0946
1,6	55	05.97 - 04.99	AEE	4		RC-VW215	0946
1,6	55	05.97 - 04.99	AEE	4		RC-VW210	0941
1,6	55	09.97 - 09.02	ALM	4		RC-ST902	7313
1,6	74	11.95 - 04.99	AFT	4		RC-VW225	0956
1,6	74	05.99 - 10.00	APF	4		RC-VW203	0934
1,6	74	05.99 - 09.02	AEH	4		RC-VW203	0934
1,6	74	05.99 - 06.00	AKL	4		RC-VW203	0934
1,8	66	10.93 - 06.96	ABS	4		RC-VW904	8622
1,8	66	11.95 - 04.99	ADZ	4		RC-VW215	0946
1,8 GTi	95	02.94 - 06.96	ADL	4		RC-VW214	0945
1,8	95	11.95 - 06.96	ADL	4		RC-VW214	0945
2,0 GTi	85	10.93 - 06.99	2E	4		RC-VW215	0946
2,0	85	09.02 - 11.09	AZL	4		RC-RN1202	4053
2,0	85	11.95 - 06.96	AGG	4		RC-VW215	0946
2,0 GTi	110	07.96 - 04.99	ABF	4		RC-VW214	0945

Exeo

1,6	75	03.09 - 09.10	ALZ	4		RC-VW254	7044
-----	----	---------------	-----	---	--	----------	------

Fura

0,9	29	01.82 - 10.86	903	4		RC-ST404	0905
0,9	33	01.82 - 10.86	100GL	4		RC-ST404	0905
1,4	55	07.80 - 08.84	15G	4		RC-ST404	0905

Ibiza

0,9	32	04.84 - 06.91		4		RC-ST404	0905
0,9	29	08.90 - 05.93		4		RC-ST601	7196
1,0	33	02.93 - 06.96	AAU	4		RC-ST902	7313
1,0	37	07.96 - 04.99	AER	4		RC-VW210	0941
1,0	37	05.99 - 02.02	ALD	4		RC-VW907	7302



kW

C
y
l

Stock-No.

SEAT**Ibiza**

1,0	37	05.99 - 06.00	ANV	4		RC-VW907	7302
1,2	45	07.91 - 01.93	1200E	4	> M4 fitment: 01.92	RC-ST1201	5575
1,2	45	07.91 - 01.93	1200E	4	01.92: DIN fitment >	RC-ST406	0907
1,2	52	07.91 - 01.93	1200I	4	> M4 fitment: 01.92	RC-ST1201	5575
1,2	52	07.91 - 01.93	1200I	4	01.92: DIN fitment >	RC-ST406	0907
1,2	77	09.10 -	CBZB	4		RC-VW1110	44316
1,3	40	02.93 - 06.96	2G	4		RC-VW216	0947
1,3	40	02.93 - 06.96	AAV	4		RC-VW210	0941
1,4	44	02.93 - 06.96	ABD	4		RC-VW206	0937
1,4	44	08.94 - 11.97	AEX	4		RC-VW206	0937
1,4	44	12.97 - 04.99	AKV	4		RC-VW206	0937
1,4	44	12.97 - 04.99	APQ	4		RC-VW206	0937
1,4	44	05.99 - 07.00	ANW	4		RC-ST901	7303
1,4	44	05.99 - 02.02	AKK	4		RC-VW210	0941
1,4	44	06.00 - 02.02	AUD	4		RC-ST901	7303
1,4	55	06.00 - 02.02	APE/AUA	4		RC-VW910	7306
1,4	55	02.02 - 12.07	BBY / BKY	4		RC-VW910	7306
1,4	74	07.96 - 04.99	AFH	4		RC-VW232	0963
1,4	74	08.99 - 02.02	AUB/BBZ	4		RC-VW910	7306
1,4	74	08.99 - 02.02	AQQ	4		RC-VW1111	44328
1,5	63	11.84 - 05.93	1500E	4	> M4 fitment: 01.92	RC-ST1201	5575
1,5	63	10.86 - 05.93	1500E	4	02.92 >	RC-ST406	0907
1,6	55	02.93 - 07.94	ABU	4		RC-VW215	0946
1,6	55	07.96 - 04.99	AEE	4		RC-VW210	0941
1,6	55	07.97 - 08.99	ALM	4		RC-VW210	0941
1,6	55	05.99 - 08.99	ALM	4		RC-ST902	7313
1,6	74	09.95 - 08.99	AFT	4		RC-VW225	0956
1,6 GTi	74	07.96 - 04.99	AFT	4		RC-VW225	0956
1,6	74	05.99 - 10.00	APF	4		RC-VW254	7044
1,6	74	01.00 - 02.02	AEH	4		RC-VW254	7044
1,6	74	07.00 - 02.02	AUR	4		RC-VW254	7044
1,6	74	02.03 - 11.09	BAH	4		RC-VW1105	7044
1,7	72	07.91 - 01.93	1700I	4		RC-ST1201	5575
1,7	72	07.91 - 01.93	1700I	4		RC-ST406	0907
1,8	66	02.93 - 07.94	ABS	4		RC-VW904	8622
1,8	66	08.94 - 04.99	ADZ	4		RC-VW904	8622
1,8 GTi	95	02.93 - 06.96	ADL	4		RC-VW214	0945
2,0 GT	85	02.93 - 07.94	2E	4		RC-VW210	0941
2,0 GTi	85	08.94 - 04.99	AGG	4		RC-VW246	7363
2,0 GTi	85	08.94 - 06.96	2E	4		RC-VW210	0941
2,0 GTi	110	07.96 - 04.99	ABF	4		RC-VW214	0945
2,0 GTi Cupra	110	05.97 - 04.99	ABF	4		RC-VW214	0945
2,0	85	04.02 -	AZL/BBX	4		RC-VW254	7044

Inca

1,4	44	11.95 - 12.97	AEX	4		RC-VW210	0941
1,4	44	01.98 - 08.00	APQ	4		RC-VW210	0941
1,4	44	01.98 - 08.00	AKV	4		RC-VW210	0941
1,4	44	09.00 -	AUD	4		RC-ST901	7303
1,4	55	04.00 - 06.03	AUA	4		RC-VW1111	44328
1,6	55	11.95 - 05.97	1F	4		RC-VW210	0941

Leon

1,2	77	02.10 -	CBZB	4		RC-VW1110	44316
1,4	55	11.99 - 06.06	AHW/APE/ AXP/BCA	4		RC-VW1111	44328
1,6	74	09.99 - 05.02	AEH	4		RC-ST204	7061
1,6	74	09.99 - 05.02	AKL	4		RC-ST204	7061



kW

C
y
l

Stock-No.

SEAT**Leon**

1,6	75	10.05 - 06.06	BFQ, BGU	4		RC-VW203	0934
1,6	75	07.05 -	CCSA/BSF	4		RC-VW254	7044
1,6 LPG	75	12.09 -	CHGA	4		RC-VW254	7044
1,6	77	09.99 - 04.01	AUS	4		RC-VW1111	44328
1,6	77	02.00 - 03.02	AZD	4		RC-VW910	7306
1,6	77	04.02 - 06.06	BCB	4		RC-VW910	7306
1,8	92	09.99 - 05.02	AGN	4		RC-VW218	0949
1,8	92	09.99 - 06.06	APG	4		RC-VW218	0949
2,8	150	02.01 - 06.06	AUE	6		RC-VW244	7358

Malaga

1,2	44	05.85 - 12.93	A1000	4		RC-ST406	0907
1,2	52	10.87 - 07.92	C1000	4		RC-ST406	0907
1,5	66	10.86 - 12.93	A2000	4		RC-ST406	0907
1,5	74	10.87 - 12.93	B2000	4		RC-ST406	0907

Marbella

0,8	25	07.86 - 04.95	850	4		RC-ST404	0905
0,9	29	07.86 - 04.95	903	4		RC-ST404	0905
0,9	29	10.89 - 04.97	903E	4		RC-ST404	0905
0,9	30	05.95 - 05.99	08NCB	4		RC-ST602	7218

Terra

0,9	29	01.87 - 12.95	09NCA	4	> 12.91	RC-FT417	0664
0,9	29	01.87 - 12.95	09NCA	4	01.92 >	RC-CR602	8480

Toledo

1,4	55	06.00 - 02.02	AHW/APE/ AUA/AXP/BCA	4		RC-VW1111	44328
1,6	55	05.91 - 10.98	1F	4		RC-VW215	0946
1,6	55	01.92 - 08.95	ABN	4		RC-VW215	0946
1,6	74	01.97 - 10.98	AFT	4		RC-VW225	0956
1,6	74	04.99 - 09.00	AEH/AKL	4		RC-ST204	7061
1,6	77	02.00 - 05.06	AZD/BCB	4		RC-VW910	7306
1,6	77	06.00 - 05.06	AUS	4		RC-VW1111	44328
1,6	75	10.04 - 05.09	BGU/CCSA	4		RC-VW254	7044
1,8	66	05.91 - 11.93	RP	4		RC-VW215	0946
1,8	66	09.93 - 12.96	ABS	4		RC-VW904	8622
1,8	66	09.94 - 10.98	ADZ	4		RC-VW246	7363
1,8	92	11.98 - 06.04	AGN	4		RC-VW218	0949
1,8	92	06.99 - 06.04	APG	4		RC-VW218	0949
1,8 GT	95	05.91 - 04.94	PL	4		RC-VW214	0945
1,8 GT	102	05.91 - 11.92	KR	4		RC-VW214	0945
2,0	85	05.91 - 12.96	2E	4		RC-VW210	0941
2,0	85	01.97 - 10.98	AGG	4		RC-VW246	7363
2,0 GT	110	03.94 - 10.98	ABF	4		RC-VW214	0945
2,3	110	11.98 - 04.01	AGZ	5		RC-VW247	7013

SKODA**105**

1,0	33	08.76 - 12.89	22	4		RC-SD401	0899
-----	----	---------------	----	---	--	----------	------

110

1,1	35	04.70 - 07.76	11	4		RC-SD401	0899
1,1	38	04.70 - 07.76	15	4		RC-SD401	0899

120

1,2	37	08.76 - 12.89	23	4		RC-SD401	0899
1,2	41	08.76 - 12.89	23S	4		RC-SD401	0899



kW

C
y
l

Stock-No.

SKODA**130**

1,3	43	01.84 - 12.89	13R	4		RC-SD401	0899
-----	----	---------------	-----	---	--	----------	------

1000MB

1,0	27	10.63 - 10.69	09R	4		RC-SD401	0899
1,0	32	03.66 - 10.69	09R	4		RC-SD401	0899
1,0	34	04.67 - 10.69	10R	4		RC-SD401	0899
1,1	34	04.69 - 06.73	12R	4		RC-SD401	0899

Estelle

1,0	33	08.76 - 12.89	22	4		RC-SD401	0899
1,2	37	03.77 - 08.83	23	4		RC-SD401	0899
1,2	41	09.83 - 12.89	23S	4		RC-SD401	0899
1,3	46	08.76 - 12.89	18	4		RC-SD401	0899
1,3	46	09.84 - 06.91	13	4		RC-SD401	0899

Fabia

1,2	63	03.10 -	CBZA	4		RC-VW1110	44316
1,2	77	03.10 -	CBZB	4		RC-VW1110	44316
1,4	55	09.99 - 03.08	AUA	4		RC-VW1111	44328
1,4	74	09.99 - 08.03	AUB	4		RC-VW910	7306
1,4	74	05.02 - 12.07	BBZ	4		RC-VW910	7306
2,0	85	07.01 - 03.08	AZL	4		RC-VW249	7015

Favorit

1,3	40	10.90 - 06.93	78113540	4		RC-MX401	0759
1,3	40	07.93 - 06.97	78113540	4		RC-SD1202	44254
1,3	43	01.89 - 06.93	78113543	4		RC-MX401	0759
1,3	43	07.93 - 06.97	78113543	4		RC-SD1202	44254
1,3	50	10.91 - 06.93	78113650	4		RC-MX401	0759
1,3	50	07.93 - 06.97	78113650	4		RC-SD1202	44254

Felicia

1,3	40	08.96 - 11.00	AMG	4	M4 Fitment	RC-SD1201	5404
1,3	40	08.96 - 11.00	AMG	4	DIN Fitment	RC-SD402	0900
1,3	43	10.94 - 07.96	1353	4	M4 Fitment	RC-SD1201	5404
1,3	50	10.94 - 07.96	136I	4	M4 Fitment	RC-SD1201	5404
1,3	50	08.96 - 11.00	AMH	4	M4 Fitment	RC-SD1201	5404
1,3	50	08.96 - 03.01	AMH	4	DIN Fitment	RC-SD402	0900
1,6	55	05.95 - 03.01	AEE	4		RC-ST902	7313

Octavia

1,2	77	02.10 -	CBZB	4		RC-VW1110	44316
1,4	55	08.00 - 07.02	AXP / BCA	4		RC-VW1111	44328
1,6	55	10.96 - 07.00	AEE	4		RC-VW903	8621
1,6	74	10.96 - 05.02	AEH	4		RC-VW254	7044
1,6	74	05.98 - 05.02	AKL	4		RC-VW254	7044
1,6	75	08.00 - 07.02	AVU	4		RC-VW254	7044
1,6 LPF / Multifuel	75	01.08 -	CHGA / CCSA / CMXA	4		RC-VW249	7015
1,8	92	10.96 - 07.00	AGN	4	> Chassis no 1UV026000	RC-AD201	0501
1,8	92	10.96 - 07.00	AGN	4	Chassis no 1UV026001 >	RC-VW236	0967
2,0	85	05.99 - 12.02	AQY	4		RC-VW254	7044
2,0	85	05.01 - 12.02	AZH	4		RC-VW249	7015

Pick Up (136)

1,3	50	10.91 - 07.95	78113650	4		RC-MX401	0759
1,3	50	06.92 - 10.96	136I	4		RC-MX401	0759

Rapid

1,2	43	01.84 - 12.86	12X	4		RC-SD401	0899
1,2	63	07.12 -	CBZA	4		RC-VW1110	44316



kW

C
y
l

Stock-No.

SKODA**Rapid**

1,2	77	07.12 -	CBZB	4		RC-VW1110	44316
1,3	43	01.84 - 12.89	13R	4		RC-SD401	0899
1,3	46	01.87 - 12.89	18R	4		RC-SD401	0899

Roomster

1,2	63	03.10 -	CBZA	4		RC-VW1110	44316
1,2	77	03.10 -	CBZB	4		RC-VW1110	44316

Superb

2,0	85	12.01 - 03.08	AZM	4		RC-VW254	7044
2,8	142	12.01 - 03.08	AMX	4		RC-AD218	0518

Yeti

1,2	77	09.09 -	CBZB	4		RC-VW1110	44316
-----	----	---------	------	---	--	-----------	-------

SMART**Cabrio**

0,6	40	09.99 - 12.02	160112	3		RC-MB1104	4070
0,6	45	10.00 - 06.03	160113	3		RC-MB1104	4070
0,7	45	01.03 - 10.03	164113	3		RC-MB1104	4070
0,7	55	01.03 - 01.04	160910	3		RC-MB1104	4070

City Coupe

0,6	33	04.98 - 12.02	160111	3		RC-MB1104	4070
0,6	40	04.98 - 12.02	160112	3		RC-MB1104	4070
0,6	45	10.00 - 06.03	160113	3		RC-MB1104	4070
0,7	37	01.03 - 10.03	164111	3		RC-MB1104	4070
0,7	45	01.03 - 10.03	164113	3		RC-MB1104	4070
0,7 Brabus	55	01.03 - 10.03	164115	3		RC-MB1104	4070

Crossblade

0,7	52	06.02 - 12.03	160920	3		RC-MB1104	4070
-----	----	---------------	--------	---	--	-----------	------

Fortwo

0,7	45	08.03 - 01.07	160910	3		RC-MB1104	4070
0,7	55	01.04 - 01.07	160910	3		RC-MB1104	4070
1,0	45	01.07 -	132910	3		RC-MB1104	4070
1,0	52	01.07 -	132910	3		RC-MB1104	4070

Roadster

0,7	45	06.03 - 11.05	160922	3		RC-MB1104	4070
0,7	60	04.03 - 11.05	160921	3		RC-MB1104	4070
0,7	74	12.03 - 11.05	160923	3		RC-MB1104	4070

SSANGYONG**Rexton**

3,2	162	04.02 -	G32D	6	Semi-Direct	RC-MB202	0737
-----	-----	---------	------	---	-------------	----------	------

SUBARU**1300**

1,3	45	10.79 - 05.85	EA65	4	10.88>	RC-FE22	8086
1,3	48	06.85 - 07.90	EA65	4		RC-FE22	8086

1600

1,6	52	04.77 - 07.90	EA71	4		RC-FE22	8086
1,6	63	05.79 - 05.85	EA71	4		RC-FE22	8086



kW

C
y
l

Stock-No.

SUBARU

1800							
1,8	59	06.85 - 07.90	EA81	4		RC-FE22	8086
1,8	60	05.79 - 05.85	EA81A	4	10.88>	RC-FE22	8086
1,8	63	06.85 - 07.89	EA81	4		RC-FE22	8086
1,8	66	06.85 - 07.87	EA81	4		RC-FE22	8086
1,8	73	05.79 - 05.85	EA81A	4	10.88>	RC-FE22	8086

1300 - 1800							
1,3		01.75 - 12.83	EA71	4		RC-FE21	8793
1,4		01.75 - 12.83	EA71	4		RC-FE21	8793
1,6		01.75 - 12.83	EA71	4		RC-FE21	8793
1,8 Turbo	66	01.83 - 12.90	EA81	4		RC-FE25	8380

Forester							
2,0	90	07.97 - 08.98	EJ20J	4	98-05>	RC-EF1201	0345
2,0	92	09.98 - 05.02	EJ202	4		RC-EF1201	0345
2,0	125	06.98 - 04.01	EJ20	4		RC-FX51	5761

Impreza							
1,6	66	08.92 - 12.00	EJ16	4	> 06.94	RC-FE39	2478
1,6	66	08.92 - 12.00	EJ16	4	07.94 >	RC-FX49	2506
1,8	76	01.93 - 06.96	EJ18E	4		RC-FX31	8456
2,0	85	11.95 - 08.98	EJ20E	4		RC-FX31	8456
2,0	92	09.98 -	EJ201	4		RC-FX31	8456
2,0	92	09.98 -	EJ201	4		RC-FX51	5761
2,0 Turbo GT	155	03.94 - 12.00	EJ20G	4		RC-EF1204	44323
2,0 Turbo	160	09.98 - 09.00	EJ205	4		RC-FX31	8456
2,0 Turbo	160	09.98 - 09.00	EJ205	4		RC-FX51	5761

Justy							
1,0	37	08.88 - 07.90	EF10	3		RC-FE30	8612
1,0	40	08.83 - 07.88	EF10	3		RC-FE30	8612
1,2	49	06.86 - 07.95	EF12	3		RC-FE30	8612
1,2	55	08.88 - 04.96	EF12E	3		RC-FE30	8612
1,3	50	05.96 - 11.03	G13BA	4		RC-EZ1202	0353

Legacy							
1,8	76	05.89 - 12.93	EJ18S	4		RC-EF1202	9166
2,0	85	06.91 - 09.98	EJ20E	4		RC-FX31	8456
2,0	85	06.91 - 12.93	EJ20E	4		RC-FX51	5761
2,0 BH5 (SOHC)	92	06.98 - 04.03	EJ20	4		RC-FX67	6856
2,2	94	01.94 - 09.98	EJ22E	4		RC-FX31	8456
2,2	100	05.89 - 12.93	EJ22E	4		RC-FX31	8456
2,5	110	01.96 - 09.98	EJ25D	4		RC-FX54	2507

Vivio							
0,7	32	08.92 - 04.00	EN07E	4		RC-EF1203	9169

SUZUKI

Alto							
0,8	29	01.86 - 10.93	F8B	3		RC-SE77	8047
1,0	40	11.93 - 09.00	G10B	4		RC-ES1201	0355
1,0	43	10.00 - 03.02	G10BB	4		RC-ES1201	0355
1,1	46	04.03 -	F10B	4	Semi-Direct	RC-SE17	2706

Baleno							
1,3	52	11.95 - 10.98	G13BA	4		RC-SE02	8312
1,3	63	03.95 - 05.02	G13BB	4	Semi-Direct: 02.99>	RC-SE17	2706
1,3	63	03.95 - 05.02	G13BB	4	>02.99	RC-SE02	8312
1,3	63	03.96 - 01.99	G13BB	4		RC-SE02	8312
1,3	63	06.97 - 05.02	G13BB	4	Semi-Direct	RC-SE17	2706
1,6	71	03.95 - 05.02	G16B	4	>02.99	RC-SE02	8312
1,6	71	03.95 - 05.02	G16B	4	Semi-Direct: 02.99>	RC-SE17	2706



kW

C
y
i

Stock-No.

SUZUKI**Baleno**

1,6	71	03.96 - 05.02	G16B	4		RC-SE02	8312
1,6	71	02.99 - 10.01	G16B	4	Semi-Direct	RC-SE17	2706

Carry

1,3	56	02.99 -	G13BB	4	Semi-Direct	RC-SE17	2706
-----	----	---------	-------	---	-------------	---------	------

Grand Vitara

1,6	69	08.98 -	G16B	4		RC-SE94	8059
1,6	71	01.98 - 04.05	G16B	4		RC-SE94	8059
1,6	71	08.98 -	G16B	4	With Coil lead	RC-SE94	8059

Ignis

1,3	61	07.00 - 09.03	M13A	4	Semi-Direct	RC-SE17	2706
1,3	69	10.03 -	M13A	4	Semi-Direct	RC-SE17	2706

Jimny

1,3	59	08.98 - 08.00	G13BB	4	Semi-Direct	RC-SE17	2706
1,3	60	02.01 -	G13BB	4	Semi-Direct	RC-SE17	2706
1,3	63	08.05 -	G13BB	4	Semi-Direct	RC-SE17	2706

Liana

1,3	66	03.01 - 03.04	M13A	4	Semi-Direct	RC-SE17	2706
1,6	76	03.01 - 08.02	M16A	4	Semi-Direct	RC-SE17	2706
1,6	76	10.01 -	M16A	4	Semi-Direct: 04.02>	RC-SE17	2706
1,6	78	09.02 -	M16A	4	Semi-Direct	RC-SE17	2706

Samurai

1,3	43	04.88 - 04.90	G13A	4		RC-SE83	8748
1,3	47	04.88 - 07.92	G13A	4		RC-SE83	8748
1,3	49	08.89 - 07.92	G13BA	4		RC-SE83	8748
1,3	51	08.92 - 08.00	G13BA	4		RC-SE83	8748

SC100

1,0	37	08.79 - 04.84	F10	4		RC-LC1201	5408
-----	----	---------------	-----	---	--	-----------	------

SJ410

1,0	34	04.82 - 03.88	F10A	4		RC-ES1202	9031
-----	----	---------------	------	---	--	-----------	------

SJ413

1,3	43	06.86 - 03.88	G13A	4		RC-SE83	8748
1,3	47	08.83 - 03.88	G13A	4		RC-SE83	8748

Super Carry

1,0	33	10.85 - 03.99	F10A	3		RC-OP403	0773
-----	----	---------------	------	---	--	----------	------

Swift

1,0	37	10.83 - 05.01	G10A	3		RC-ES1207	44322
1,0	39	03.89 - 10.96	G10A	3		RC-SE77	8047
1,3	49	06.86 - 02.89	G13A	4		RC-LC1201	5408
1,3	50	08.85 - 02.89	G13A	4		RC-LC1201	5408
1,3	50	03.89 - 10.96	G13BA	4		RC-LC1201	5408
1,3	50	09.91 - 05.01	G13B	4		RC-SE93	8073
1,3	51	03.89 - 06.00	G13BA	4		RC-LC1201	5408
1,3	66	01.06 -	M13A	4		RC-SE17	2706
1,3	74	07.86 - 08.89	G13B	4	Chassis No. SF413, AA34	RC-SE82	2717
1,3	74	09.89 - 05.01	G13B	4	Chassis No. SF413, AA34	RC-SE82	2717
1,6	68	03.89 - 05.01	G16B	4		RC-SE02	8312
1,6	68	03.89 - 05.01	G16B	4	> 03.99	RC-SE17	2706
1,6	71	03.89 - 07.92	G16B	4		RC-SE02	8312

Vitara

1,6	55	08.88 - 08.95	G16A	4		RC-SE83	8748
1,6	59	07.88 - 03.98	G16A	4	With Coil lead	RC-SE95	8068
1,6	59	08.88 - 08.00	G16A	4	03.95 >	RC-ES1204	44314



kW

C
y
l

Stock-No.

SUZUKI**Vitara**

1,6	59	08.88 - 08.95	G16A	4		RC-SE83	8748
1,6	59	08.88 - 09.91	G16AC	4		RC-SE94	8059
1,6	60	07.88 - 12.91	G10A	4	With Coil lead	RC-SE95	8068
1,6	71	07.90 - 03.99	G16B	4	With coil lead > 02.95	RC-SE95	8068
1,6	71	06.91 - 12.98	G16B	4	> 02.95	RC-SE94	8059
1,6	71	06.91 - 12.98	G16B	4	02.95 >	RC-ES1204	44314

Wagon R+

1,0	48	07.97 - 01.00		4		RC-SE13	3067
1,0	51	08.00 - 07.03	K10A	4		RC-SE94	8059
1,2	51	05.98 - 01.00	K12A	4		RC-SE13	3067
1,3	56	02.00 - 08.03	G13BB	4	Semi-Direct	RC-SE17	2706
1,3	69	09.03 -	M13A	4	Semi-Direct	RC-SE17	2706

X-90

1,6	71	09.95 -	G16B	4	With Coil lead	RC-SE95	8068
1,6	71	11.95 - 10.97	G16B	4	With Coil lead	RC-SE94	8059

TOYOTA**4 Runner**

3,0	105	01.90 - 11.95	3VZE	6		RC-ET1213	9150
3,0	112	01.90 - 08.92	3VZE	6		RC-ET1213	9150
3,4	136	11.95 - 06.99	5VZFE	6		RC-TE66	2899

Avensis

1,6	81	10.97 - 06.00	4AFE	4		RC-ET1301	9171
1,8	81	10.97 - 06.00	7AFE	4		RC-ET1217	5914
2,0	94	10.97 - 06.00	3SFE	4		RC-TE58	5361

Camry

1,8 SV40		-	4SFE	4		RC-TE44	5351
2,0	88	11.86 - 05.91	3SFE	4		RC-ET1207	9098
2,0	94	11.86 - 05.91	3SFE	4		RC-ET1207	9098
2,0 SV41/42/43		-	3SFE	4		RC-TE44	5351
2,0 SV21/25		-	3SFE	4		RC-TE26	5348
2,2	96	08.96 - 07.01	5SFE	4		RC-TE58	5361
2,2	100	06.91 - 07.96	5SFE	4		RC-TE43	9618
3,0	135	08.96 - 07.01	3VZFE	6		RC-TE42	9617
3,0	138	06.91 - 07.96	3VZFE	6		RC-TE42	9617
3,0	140	08.96 - 07.01	3VZFE	6		RC-TE42	9617

Carina

1,6	52	11.70 - 07.77	2T	4		RC-TE86	9641
1,6	52	05.85 - 11.87	4ALC	4		RC-TE93	9649
1,6	55	08.77 - 09.83	2T	4		RC-TE86	9641
1,6 AT171	55	10.83 - 11.87	4ALC	4	Katalysator	RC-TX03	9664
1,6	63	08.72 - 07.81	2TB	4		RC-TE86	9641
1,6	63	08.77 - 07.81	2T	4		RC-TE86	9641
1,6	63	10.83 - 11.87	4AL	4		RC-TE93	9649
1,6	66	12.87 - 11.89	4AF	4		RC-TE24	9609
1,6	66	12.87 - 11.89	4AF	4		RC-ET1208	9099
1,6	70	12.87 - 03.92	4AF	4		RC-ET1208	9099
1,6	73	02.92 - 09.97	4AFEL	4		RC-ET1214	9167
1,6	73	02.92 - 09.97	4AFEL	4	With Coil Lead	RC-ET1301	9171
1,6	75	12.87 - 03.92	4AFE	4		RC-TE24	9609
1,6	77	12.87 - 03.92	4AFE	4		RC-ET1214	9167
1,6	77	12.87 - 03.92	4AFE	4		RC-ET1208	9099
1,6	78	10.94 - 09.97	4AFE	4		RC-ET1214	9167
1,6	78	10.94 - 09.97	4AFE	4	With Coil Lead	RC-ET1301	9171



kW

C
y
l

Stock-No.

TOYOTA**Carina**

1,6	79	02.92 - 09.94	4AFE	4		RC-ET1214	9167
1,6	79	02.92 - 09.94	4AFE	4	With Coil Lead	RC-ET1301	9171
1,6	79	02.92 - 09.94	4AFE	4		RC-TE41	9616
1,6	85	02.92 - 09.97	4AFE	4		RC-ET1214	9167
1,6	85	02.92 - 09.97	4AFE	4	With Coil Lead	RC-ET1301	9171
1,8 DLX	57	08.79 - 07.81	3TC	4		RC-TE86	9641
1,8	57	09.81 - 09.83	3TC	4		RC-TE86	9641
1,8	62	08.79 - 09.83	3T	4		RC-TE86	9641
1,8 DLX	62	08.81 - 08.82	3TC	4		RC-TE86	9641
1,8	62	08.82 - 09.83	3TC	4		RC-TE86	9641
1,8	79	12.94 - 09.97	7AFEL	4		RC-ET1214	9167
1,8	79	12.94 - 06.98	7AFEL	4	With Coil Lead	RC-ET1301	9171
1,8	85	04.92 - 09.97	7AFE	4		RC-ET1214	9167
1,8	85	04.92 - 09.97	7AFE	4	With Coil Lead	RC-ET1301	9171
1,8	92	10.94 - 09.97	7AFE	4		RC-ET1214	9167
1,8 ST200/201		-	4SFE	4		RC-TE44	5351
1,8 ST190		-	4ST190	4		RC-TE48	5352
1,8 ST170/G		-	4SFI	4		RC-TE25	5347
2,0	88	12.87 - 03.92	3SFE	4		RC-TE24	9609
2,0	93	11.94 - 09.97	3SFE	4		RC-TE43	9618
2,0	94	12.87 - 03.92	3SFE	4		RC-TE24	9609
2,0 GTSi	98	02.92 - 09.97	3SFE	4		RC-TE43	9618
2,0 GT	116	02.92 - 09.97	3SGE	4		RC-ET1201	9058
2,0 ST182/183		-	3SFE	4		RC-TE48	5352
2,0 ST202/203		-	3SFE	4		RC-TE44	5351
2,0 ST182/183		-	3SFE	4		RC-TE25	5347

Celica

1,6	63	08.77 - 07.81	2TB	4	08.81>	RC-TE86	9641
1,6	63	08.81 - 07.85	2TB	4		RC-TE86	9641
1,6	77	09.89 - 10.93	4AFE	4		RC-TE24	9609
1,6 GTi	85	08.85 - 07.87	4AGEL	4		RC-TX02	3715
1,6 GTi	85	08.87 - 08.89	4AGELC	4		RC-TX02	3715
1,6	85	09.89 - 07.91	4AFE	4		RC-TE24	9609
1,6 GTi	91	08.83 - 07.85	4AGE	4		RC-TX02	3715
1,6 GTi	91	08.85 - 08.89	4AGEL	4		RC-TX02	3715
1,8 GT	85	11.93 - 12.97	7AFE	4		RC-ET1214	9167
1,8		-	4SFI	4		RC-ZX49	8932
2,0	63	10.75 - 07.81	18R	4		RC-TE83	8291
2,0	77	08.81 - 07.85	21RC	4		RC-TX99A	0329
2,0	86	10.75 - 07.83	18RG	4		RC-TE83	8291
2,0 GT	91	08.77 - 07.81	18RG	4		RC-TE83	8291
2,0 GTi	103	08.85 - 08.89	3SGELC	4		RC-TX06	9684
2,0 GTi	103	08.87 - 08.88	3SGEL	4		RC-TX06	9684
2,0 GTi	110	08.85 - 08.89	3SGEL	4		RC-TX06	9684
2,0 GTi	115	10.89 - 01.94	3S-GE	4		RC-ET1228	44320
2,0 GTi	125	04.96 - 08.99	3SGER	4		RC-TX117	2908
2,0 GTi	129	11.93 - 08.99	3SGER	4		RC-TX117	2908
2,0 Turbo	136	10.87 - 10.91	3SGTE	4		RC-ET1219	6367
2,0 Turbo	150	08.91 - 10.93	3SGTE	4		RC-ET1219	6367
2,0 Turbo	178	02.94 - 08.97	3SGTE	4		RC-TX117	2908
2,0 ST182/183		-	3SFE	4		RC-TE48	5352
2,0 ST202/203		-	3SFE	4		RC-TE44	5351
2,0 ST182/183		-	3SFE	4		RC-TE25	5347
2,0		-	1GEU	6		RC-TE95	5382
2,8	125	12.81 - 12.85	5MGE	6		RC-ET1211	9112



kW

C
y
l

Stock-No.

TOYOTA**Corolla**

1,2	41	08.74 - 07.79	3KC	4		RC-TE87	9643
1,2	41	01.77 - 07.79	3KH	4		RC-TE87	9643
1,3	46	08.79 - 07.83	4K	4		RC-TE87	9643
1,3	48	01.82 - 12.85	4K	4		RC-TE88	9529
1,3	51	08.83 - 04.87	2AL	4		RC-ET1203	9072
1,3	52	05.87 - 04.92	2E	4		RC-ET1202	9059
1,3	55	08.85 - 10.89	2E	4		RC-ET1202	9059
1,3	55	08.89 - 04.92	2EE	4		RC-ET1202	9059
1,3	55	08.95 - 04.97	4EFE	4		RC-TE54	5357
1,3	55	08.95 - 04.97	4EFEL	4		RC-TE41	9616
1,3	60	05.87 - 04.92	2E	4		RC-ET1202	9059
1,3	63	05.97 - 09.99	4EFE	4		RC-TE51	5355
1,3	65	05.92 - 07.95	4EFE	4		RC-TE41	9616
1,3		01.86 -	3K	4		RC-TE88	9529
1,5 EL43/45		-	5EFE	4		RC-TE54	5357
1,5 EL43		-	5EFHE	4		RC-TE75	5362
1,6	52	05.85 - 09.87	4ALC	4		RC-TE93	9649
1,6	55	01.77 - 07.83	2T	4		RC-TE86	9641
1,6	63	01.77 - 07.83	2TB	4		RC-TE86	9641
1,6	63	08.83 - 04.87	4AL	4		RC-TE93	9649
1,6	66	05.87 - 08.95	4AF	4		RC-ET1208	9099
1,6	70	05.87 - 08.95	4AF	4		RC-ET1208	9099
1,6 AE82	73	06.83 - 08.87	4ALC	4	Katalysator	RC-TX03	9664
1,6	77	02.88 - 08.95	4AFE	4		RC-TE24	9609
1,6	77	09.89 - 08.90	4AFE	4		RC-ET1214	9167
1,6 XL Twin Cam	77	09.89 - 05.92	4AFE	4		RC-TE24	9609
1,6 GT	79	08.79 - 07.83	2TG	4		RC-TE86	9641
1,6	81	09.90 - 08.93	4AFE	4		RC-TE24	9609
1,6	81	05.97 - 09.99	4AFE	4		RC-ET1214	9167
1,6	84	06.83 - 08.87	4ALC	4	Katalysator	RC-TE93	9649
1,6	84	08.95 - 04.97	4AFEL	4		RC-ET1214	9167
1,6 GTi	85	05.85 - 04.87	4AGEC	4		RC-TX02	3715
1,6	85	10.85 - 02.87	4AGEC	4		RC-ET1210	9111
1,6 GTi	85	08.87 - 04.92	4AGE	4		RC-ET1221	44261
1,6	85	05.92 - 07.95	4AFE	4		RC-ET1214	9167
1,6	85	05.92 - 07.95	4AFE	4		RC-TE41	9616
1,6 GT 16V	89	08.85 - 08.87	4AGEL	4		RC-TX35	9706
1,6 GTi	91	08.83 - 04.87	4AGE	4		RC-ET1210	9111
1,6 GT	91	10.83 - 06.91	4AGE	4		RC-ET1210	9111
1,6 GT	91	05.85 - 04.87	4AGEL	4		RC-TX02	3715
1,6 GTi	91	05.87 - 04.92	4AGE	4		RC-ET1221	44261
1,6 AE111, A101/G		05.85 - 04.87	4AGE	4		RC-TE55	5358
1,8	81	09.92 - 10.01	7AFE	4		RC-ET1214	9167
1,8	88	09.92 - 11.93	7AFE	4		RC-ET1214	9167

Corona

1,8	62	09.78 - 12.81	3T	4		RC-TE86	9641
1,8 ST200/201		-	4SFE	4		RC-TE44	5351
2,0 ST202/203		-	3SFE	4		RC-TE44	5351

Cressida

2,0	80	08.82 - 04.85	1GE	6		RC-NE29	5764
2,0	110	08.82 - 04.85	1GE	6		RC-NE29	5764
2,2		01.86 -	5M/4M/M	6		RC-TE81	9630

Crown

2,0 GS117V		-	1GEJ	6		RC-TE95	5382
2,0 GS130/G/131//136V		-	1GE	6		RC-TE95	5382
2,0 GS110		-	1GEU	6		RC-TE95	5382



kW

C
y
l

Stock-No.

TOYOTA**Crown**

2,5 JZS171/W		-	1JZGTE	6		RC-TE79	5381
2,5 JZS151/153		-	1JZGE	6		RC-TE79	5381
3,0 JZS155		-	2JZGE	6		RC-TE79	5381

Curren

1,8 ST208		-	4SFE	4		RC-TE44	5351
2,0 ST206/207		-	3SFE	4		RC-TE44	5351

Hiace

2,0	65	12.82 - 08.89	3Y	4		RC-TE87	9643
2,0	74	08.89 - 04.98	1RZ	4		RC-TE121	2818
2,4	89	08.89 - 07.95	2RZE	4		RC-ET1218	5919
2,7	105	11.95 - 11.01	3RZ-FE	4		RC-ET1229	44321
2,7	106	11.01 - 08.06	3RZ-FE	4		RC-ET1229	44321

Hilux

1,8	58	08.83 - 07.88	2Y	4		RC-TE87	9643
1,8	58	08.88 - 08.94	2Y	4	>12.89	RC-TE87	9643
2,0	65	08.83 - 07.88	3Y	4		RC-TX05	9681
2,0 4 Runner	65	08.85 - 07.88	3Y	4		RC-TX05	9681
2,2	69	08.86 - 08.94	4Y	4		RC-TX05	9681

Landcruiser

2,4	77	11.84 - 05.93	22R	4		RC-ET1220	6369
2,4	81	09.85 - 12.89	22R	4		RC-ET1220	6369
3,4	131	04.95 - 08.02	5VZFE	6		RC-TE66	2899
4,2	88	03.69 - 10.84	2F	6		RC-ET1212	9137
4,2	89	02.75 - 10.84	2F	6		RC-ET1212	9137
4,5	151	02.95 - 12.97	5FGE	6		RC-TE68	2902
4,5	151	02.95 - 12.97	1FZFE	6		RC-TE68	2902

Liteace

1,5	52	10.85 - 12.91	5K	4		RC-TE87	9643
2,2	75	01.92 - 01.95	4YEC	4		RC-TX05	9681

Model F

1,8	58	11.82 - 07.86	2Y	4		RC-TX05	9681
2,0	64	08.86 - 07.88	3YC	4		RC-TX05	9681
2,0	65	11.82 - 01.90	3Y	4		RC-TX05	9681
2,2	72	08.88 - 01.90	4YEC	4		RC-TX05	9681

MR-2

1,6 GT	85	11.85 - 10.89	4AGELC	4		RC-TX142	5792
1,6 GT	91	11.84 - 10.89	4AGEL	4		RC-TX35	9706
1,6 16V (AW11)	91	04.85 - 11.89	4AGEL	4		RC-TX35	9706
2,0 GT	115	11.89 - 05.00	3SGE	4		RC-ET1216	5908

Paseo

1,5	66	08.95 - 12.99	5EFE	4		RC-TE41	9616
-----	----	---------------	------	---	--	---------	------

Picnic

2,0	90	01.01 - 12.01	3SFE	4		RC-TE58	5361
2,0	94	08.96 - 05.00	3SFE	4		RC-TE58	5361

Previa

2,4	97	01.90 - 08.96	2TZFE	4	Chassis No. TCR10: KAT	RC-TX71	5384
2,4	97	05.90 - 07.96	2TZFE	4	Chassis No. TCR21: 05.90 - 08.93	RC-TX71	5384
2,4	97	08.96 - 01.00	2TZFE	4	Chassis No. TCR11: KAT	RC-TX71	5384

RAV 4

2,0	94	12.97 - 04.00	3SFE	4	Chassis No. SXA1_	RC-ET1222	44262
2,0	95	04.94 - 04.00	3SFE	4	Chassis No. SXA11	RC-ET1222	44262
2,0 SXA 10G/11G		-	3SFE	4		RC-TE44	5351



kW

C
y
l

Stock-No.

TOYOTA**Starlet**

1,0	35	02.78 - 09.84	2K	4		RC-TE87	9643
1,0	40	10.84 - 11.89	1EL	4		RC-TE141	5774
1,2	41	02.78 - 05.80	3KH	4		RC-TE87	9643
1,3	41	02.78 - 09.84	4K	4		RC-TE87	9643
1,3	46	08.81 - 09.84	4K	4		RC-TE87	9643
1,3	55	01.85 - 11.89	2ELC	4		RC-TE17	9606
1,3	55	12.89 - 12.95	2EE	4		RC-TX118	5383
1,3	55	01.96 - 07.99	4EFE	4		RC-TE41	9616
1,3 EP82/85		-	4EFE	4		RC-TE54	5357
1,3 EP82/85		-	4EFTE	4		RC-TE52	5356

Supra

2,0 GA70		-	1GEU	6		RC-TE95	5382
2,8		-	5M	6		RC-TE81	9630
3,0	140	01.86 - 08.90	7MGE	6		RC-TX07	9687
3,0	150	01.86 - 08.89	7MGE	6		RC-TX07	9687
3,0 Turbo	175	08.87 - 04.93	7MGTE	6		RC-TX08	9692
3,0i Bi-Turbo	243	05.93 - 08.02	2JZ-GTE	6		RC-ET1227	44319

Tercel

1,3	48	06.79 - 08.84	2A	4		RC-ET1204	9076
1,3	48	09.82 - 08.84	2A	4	Katalysator	RC-TX03	9664
1,3 EL41		-	4EFE	4		RC-TE54	5357
1,5	52	10.82 - 12.86	3AC	4	Katalysator	RC-TX03	9664
1,5 EL43/45		-	5EFE	4		RC-TE54	5357
1,5 EL43		-	5EFHE	4		RC-TE75	5362
1,6 AL21/AL25		01.83 - 12.88	3AC	4	Katalysator	RC-TX03	9664

Vista

1,8 SV40		-	4SFE	4		RC-TE44	5351
2,0 SV41/42/43		-	3SFE	4		RC-TE44	5351

TRABANT**601**

0,6	19	07.66 - 10.90	CD2	2		RC-MX1214	5975
-----	----	---------------	-----	---	--	-----------	------

Trabi

1,0	30	08.89 - 12.92	GL	4		RC-MX1212	5589
-----	----	---------------	----	---	--	-----------	------

TRIUMPH**1500**

1,5	42	03.70 - 03.75	1EL	4		RC-RN1201	6981
1,5	49	10.70 - 03.75	1EH	4		RC-RN1201	6981
1,5	53	04.75 - 06.80	1E	4		RC-RN1201	6981

Acclaim

1,3	52	08.81 - 09.86	EN4	4		RC-HE32	9105
-----	----	---------------	-----	---	--	---------	------

Spitfire

1,5	40	12.74 - 10.78	FM11	4		RC-RV406	0881
1,5	52	11.76 - 08.80	FM11	4		RC-RV406	0881

Stag

3,0	105	02.69 - 12.79	LF20	8		RC-MX1215	6218
-----	-----	---------------	------	---	--	-----------	------

UAZ**31512**

2,3	73	-	3M3-4021.9	4		RC-MX1203	4945
2,3	73	-	3M3-401	4		RC-MX1203	4945



kW

C
y
l

Stock-No.

UAZ

31514

2,3	73	-	3M3-401	4		RC-MX1203	4945
-----	----	---	---------	---	--	-----------	------

31516

		-	-			RC-MX1203	4945
--	--	---	---	--	--	-----------	------

31519

		-	-			RC-MX1203	4945
--	--	---	---	--	--	-----------	------

3741 / 3909 / 3962

		-	-			RC-MX1203	4945
--	--	---	---	--	--	-----------	------

VOLKSWAGEN

1302

1,2	25	08.70 - 07.72	D	4		RC-VW217	0948
-----	----	---------------	---	---	--	----------	------

1,3	32	08.70 - 07.72	AB	4		RC-VW217	0948
-----	----	---------------	----	---	--	----------	------

1303

1,2	25	08.72 - 12.79	D	4		RC-VW217	0948
-----	----	---------------	---	---	--	----------	------

1,3	32	08.70 - 07.79	AB	4		RC-VW217	0948
-----	----	---------------	----	---	--	----------	------

Bora

1,4	55	03.00 - 05.05	AHW/AKQ/ APE/AXP	4		RC-VW1111	44328
-----	----	---------------	---------------------	---	--	-----------	-------

1,6	74	08.98 - 06.02	AEH	4		RC-VW254	7044
-----	----	---------------	-----	---	--	----------	------

1,6	74	05.99 - 09.00	APF	4		RC-VW254	7044
-----	----	---------------	-----	---	--	----------	------

1,6	75	05.00 - 04.02	AVU	4		RC-VW254	7044
-----	----	---------------	-----	---	--	----------	------

1,6	77	11.01 - 05.05	ATN/AUS/ AZD	4		RC-VW910	7306
-----	----	---------------	-----------------	---	--	----------	------

1,8	92	11.98 - 09.00	AGN	4		RC-VW236	0967
-----	----	---------------	-----	---	--	----------	------

2,0	85	08.98 - 07.01	APK	4		RC-VW254	7044
-----	----	---------------	-----	---	--	----------	------

2,0	85	08.98 - 05.00	AQY	4		RC-VW254	7044
-----	----	---------------	-----	---	--	----------	------

2,0	85	04.00 - 04.02	AZG	4		RC-VW254	7044
-----	----	---------------	-----	---	--	----------	------

2,0	85	10.00 - 05.01	AZH	4		RC-VW254	7044
-----	----	---------------	-----	---	--	----------	------

2,0	85	08.98 - 05.05	AZJ	4		RC-VW1107	44227
-----	----	---------------	-----	---	--	-----------	-------

2,3 VR5	110	08.98 - 02.01	AGZ	5		RC-VW235	0966
---------	-----	---------------	-----	---	--	----------	------

2,3 VR5	110	05.99 - 02.01	AGZ	5		RC-VW247	7013
---------	-----	---------------	-----	---	--	----------	------

2,8	150	05.99 - 05.00	AQP	6		RC-VW244	7358
-----	-----	---------------	-----	---	--	----------	------

2,8	150	05.00 - 05.01	AUE	6		RC-VW244	7358
-----	-----	---------------	-----	---	--	----------	------

2,8	150	06.01 - 05.05	BDE	6		RC-VW244	7358
-----	-----	---------------	-----	---	--	----------	------

Caddy

1,2	63	09.10 -	CBZA	4		RC-VW1110	44316
-----	----	---------	------	---	--	-----------	-------

1,2	77	09.10 -	CBZB	4		RC-VW1110	44316
-----	----	---------	------	---	--	-----------	-------

1,4	44	11.95 - 12.97	AEX	4		RC-VW903	8621
-----	----	---------------	-----	---	--	----------	------

1,4	55	08.00 - 01.04	AUA	4		RC-VW1111	44328
-----	----	---------------	-----	---	--	-----------	-------

1,5	51	10.82 - 10.83	JB	4		RC-VW1102	2569
-----	----	---------------	----	---	--	-----------	------

1,6	55	08.83 - 10.92	EW	4	M4 fitment	RC-VW210	0941
-----	----	---------------	----	---	------------	----------	------

1,6	55	08.83 - 10.92	EW	4	DIN fitment: >07.84	RC-VW1103	2573
-----	----	---------------	----	---	---------------------	-----------	------

1,6	55	06.96 - 12.00	AEE	4		RC-VW903	8621
-----	----	---------------	-----	---	--	----------	------

1,8	70	08.85 - 10.92	JH	4		RC-VW210	0941
-----	----	---------------	----	---	--	----------	------

1,6	75	04.04 - 09.10	BGU/BSF/BSE	4		RC-VW249	7015
-----	----	---------------	-------------	---	--	----------	------

1,8	75	04.04 - 09.10	BGU/BSF/BSE	4		RC-VW254	7044
-----	----	---------------	-------------	---	--	----------	------

2,0	80	04.06 -	BSX	4		RC-VW1107	44227
-----	----	---------	-----	---	--	-----------	-------

Caravelle

1,6	37	08.73 - 12.80	AS	4		RC-VW1102	2569
-----	----	---------------	----	---	--	-----------	------

1,9	57	08.82 - 08.90	DG	4	M4 fitment	RC-VW210	0941
-----	----	---------------	----	---	------------	----------	------

1,9	57	08.82 - 08.90	DG	4	DIN fitment	RC-VW1102	2569
-----	----	---------------	----	---	-------------	-----------	------

2,0	51	08.75 - 04.79	CJ	4		RC-VW1102	2569
-----	----	---------------	----	---	--	-----------	------

2,0	51	08.75 - 07.76	GD	4		RC-VW1102	2569
-----	----	---------------	----	---	--	-----------	------



kW

C
y
l

Stock-No.

VOLKSWAGEN**Caravelle**

2,0	51	08.76 - 04.79	GE	4		RC-VW1102	2569
2,0	62	09.90 - 04.03	AAC	4	01.91> > 12.93	RC-VW219	0950
2,1	82	08.85 - 08.90	DJ	4		RC-VW210	0941
2,5	81	09.90 - 06.94	AAF	5		RC-AD216	0516
2,5	81	07.94 - 08.96	ACU	5		RC-VW902	8618
2,5	81	07.94 - 07.95	AEN	5		RC-AD216	0516
2,5	81	05.96 - 05.00	AET	5		RC-VW902	8618
2,5	81	05.98 - 05.00	AEU	5		RC-AD216	0516
2,5	85	05.98 - 05.00	AET	5		RC-VW902	8618

Corrado

1,8	100	09.88 - 07.92	KR	4		RC-VW239	0970
1,8 G60	118	09.88 - 04.94	PG	4		RC-VW210	0941
2,0	85	08.92 - 06.94	2E	4		RC-VW210	0941
2,0	85	07.94 - 05.95	ADY	4		RC-VW215	0946
2,0	100	08.91 - 06.94	9A	4		RC-VW239	0970
2,9 VR6	140	08.91 - 05.95	ABV	6	With Coil lead: >12.93	RC-VW223	0954
2,9 VR6	140	08.91 - 05.95	ABV	6	Without Coil lead: 01.94>	RC-VW201	0932

Derby

0,9	29	07.76 - 09.81	HA	4		RC-VW1102	2569
1,0	29	09.85 - 10.86	GL	4		RC-VW1104	2576
1,1	37	07.76 - 07.83	HB	4		RC-VW1102	2569
1,1	44	07.76 - 09.81	HC	4		RC-VW1102	2569
1,3	40	08.83 - 07.84	HK	4		RC-VW210	0941
1,3	40	08.83 - 07.84	HK	4		RC-VW1102	2569
1,3	44	02.77 - 07.84	HH	4		RC-VW1102	2569
1,3	55	09.85 - 07.89	GK	4		RC-VW210	0941
1,3	55	09.85 - 07.89	GK	4		RC-VW1102	2569

Fox

1,4	55	04.05 -	BKR	4		RC-VW1105	7044
-----	----	---------	-----	---	--	-----------	------

Golf

1,0	33	08.83 - 07.85	GN	4		RC-VW218	0949
1,0	37	08.85 - 07.91	HZ	4		RC-VW210	0941
1,1	37	04.74 - 07.79	FA	4		RC-VW1102	2569
1,1	37	08.80 - 07.83	GG	4		RC-VW1102	2569
1,1	38	08.76 - 07.80	FJ	4		RC-VW1102	2569
1,2	63	05.10 - 11.12	CBZA	4		RC-VW1110	44316
1,2	77	05.09 -	CBZB	4		RC-VW1110	44316
1,3	40	08.83 - 07.85	HK	4		RC-VW210	0941
1,3	40	08.85 - 07.88	MH	4		RC-VW210	0941
1,3	40	08.85 - 07.91	NZ	4		RC-VW210	0941
1,3	40	08.89 - 07.91	2G	4		RC-VW216	0947
1,3	43	08.83 - 07.86	GT	4		RC-VW216	0947
1,3	44	08.78 - 07.83	GF	4		RC-VW1102	2569
1,4	40	08.91 - 07.95	ABD	4		RC-VW903	8621
1,4	44	08.91 - 05.99	AEX	4		RC-VW903	8621
1,4	44	05.93 - 04.99	ABD	4		RC-VW903	8621
1,4	44	12.97 - 05.98	APQ	4	08.95 >	RC-VW903	8621
1,4	44	12.97 - 05.98	APQ	4	> 07.95	RC-ST201	0901
1,4	55	09.00 - 06.06	AHW/AKQ/ APE/AXP	4		RC-VW1111	44328
1,4	55	10.03 -	BGU	4		RC-VW910	7306
1,5	51	08.76 - 07.83	JB	4		RC-VW1101	2565
1,6	51	08.85 - 07.91	PN	4		RC-VW210	0941
1,6	51	08.86 - 07.91	EZA	4		RC-VW210	0941
1,6	53	04.86 - 07.90	RE	4		RC-VW210	0941
1,6	53	08.88 - 07.91	RF	4		RC-VW210	0941
1,6	55	04.74 - 07.78	FP	4		RC-VW1101	2565



kW

C
y
l

Stock-No.

VOLKSWAGEN**Golf**

1,6	55	08.83 - 07.86	EW	4		RC-VW210	0941
1,6	55	08.83 - 07.91	EZ	4		RC-VW210	0941
1,6	55	08.83 - 07.88	HM	4		RC-VW210	0941
1,6	55	08.91 - 07.95	ABU	4		RC-VW210	0941
1,6	55	10.94 - 07.95	AEA	4		RC-VW216	0947
1,6	55	08.95 - 09.97	AEE	4		RC-VW210	0941
1,6	74	08.91 - 12.95	AEK	4		RC-VW227	0958
1,6	74	08.94 - 09.00	AFT	4		RC-VW912	7318
1,6	74	10.97 - 09.03	AEH	4		RC-VW254	7044
1,6	74	10.97 - 09.03	AKL	4		RC-VW254	7044
1,6	74	05.99 - 08.00	APF	4		RC-VW254	7044
1,6 Rabbit	75	09.00 - 05.01	AVU	4		RC-VW254	7044
1,6	75	09.00 - 05.01	AVU	4		RC-VW254	7044
1,6	75	01.04 -	BGU	4		RC-VW249	7015
1,6	75	10.08 -	CCSA	4		RC-VW249	7015
1,6	75	10.08 -	BSF	4		RC-VW249	7015
1,6	75	10.08 -	BSE	4		RC-VW249	7015
1,6	77	02.02 - 06.05	ATN/AUS/AZD	4		RC-VW910	7306
1,6 BiFuel	75	03.09 -	CHGA	4		RC-VW249	7015
1,6 GTi	81	02.76 - 07.83	EG	4		RC-VW1101	2565
1,8	55	08.91 - 09.00	AAM	4		RC-VW246	7363
1,8	55	12.97 - 09.00	ANN	4		RC-VW246	7363
1,8	62	08.88 - 07.89	RH	4		RC-VW210	0941
1,8	66	08.83 - 12.92	EX	4		RC-VW210	0941
1,8	66	08.83 - 07.89	GU	4		RC-VW903	8621
1,8	66	08.83 - 07.88	GX	4		RC-VW903	8621
1,8	66	04.84 - 07.87	HV	4		RC-VW210	0941
1,8	66	08.87 - 07.91	RP	4		RC-VW215	0946
1,8	66	08.91 - 07.95	ABS	4		RC-VW220	0951
1,8	66	10.94 - 09.00	ADZ	4		RC-VW904	8622
1,8	66	12.97 - 06.02	ANP	4		RC-VW904	8622
1,8	70	08.83 - 07.89	JH	4		RC-VW215	0946
1,8	72	08.88 - 07.91	1P	4		RC-VW246	7363
1,8	72	08.89 - 07.93	2H	4		RC-VW208	0939
1,8 GTi	79	08.89 - 07.91	PF/RD	4		RC-VW215	0946
1,8 GTi	82	08.82 - 07.83	DX	4		RC-VW1101	2565
1,8	82	08.83 - 12.92	DX	4		RC-VW1101	2565
1,8 GTi	82	08.83 - 07.88	GZ	4		RC-VW210	0941
1,8 GTi	82	01.84 - 07.87	EV	4		RC-VW215	0946
1,8 GTi	82	03.87 - 07.91	PB	4		RC-VW210	0941
1,8 GTi	82	08.88 - 07.89	PF	4		RC-VW215	0946
1,8	92	10.97 - 08.00	AGN	4		RC-VW236	0967
1,8 GTi	95	08.85 - 07.91	PL	4		RC-VW214	0945
1,8 GTi	98	08.86 - 07.89	KR	4		RC-VW214	0945
1,8 GTi	102	08.85 - 07.91	KR	4		RC-VW214	0945
1,8 G60	118	08.88 - 07.89	1H	4		RC-VW210	0941
1,8 G60	118	08.89 - 07.91	PG	4		RC-VW246	7363
1,8 G60 GTi	118	04.90 - 07.91	PG	4		RC-VW246	7363
2,0	85	08.91 - 04.99	ADY	4		RC-VW210	0941
2,0	85	08.91 - 07.94	2E	4		RC-VW210	0941
2,0	85	08.95 - 09.00	AGG	4		RC-VW210	0941
2,0	85	04.97 - 09.00	AKR	4		RC-VW904	8622
2,0	85	07.93 - 04.99	AKR	4		RC-VW246	7363
2,0	85	06.98 - 06.06	AQY	4		RC-VW254	7044
2,0	85	04.99 - 09.00	ATU	4		RC-VW904	8622
2,0	85	05.99 - 09.03	AQY	4		RC-VW254	7044
2,0	85	09.00 - 06.05	AZH	4		RC-VW249	7015



kW

C
y
l

Stock-No.

VOLKSWAGEN**Golf**

2,0	85	10.00 - 07.01	AWF	4		RC-VW904	8622
2,0	85	10.00 - 07.01	AWG	4		RC-VW904	8622
2,0	85	06.01 - 06.06	AZG/AZJ/BEH	4		RC-VW254	7044
2,0 GTi	110	08.91 - 09.97	ABF	4		RC-VW214	0945
2,3 VR5	110	10.97 - 06.06	AGZ	5		RC-VW235	0966
2,3 VR5	110	10.97 - 06.06	AGZ	5		RC-VW247	7013
2,8 VR6	120	08.95 - 09.97	AAA	6		RC-VW223	0954
2,8 VR6	120	08.95 - 09.97	AAA	6		RC-VW201	0932
2,8 VR6 GTi	128	08.91 - 07.95	AAA	6	With Coil lead: >12.93	RC-VW223	0954
2,8 VR6 GTi	128	08.91 - 07.95	AAA	6	Without Coil lead: 01.94>	RC-VW201	0932
2,8 VR6	128	08.95 - 09.97	AAA	6	With Coil lead: >12.93	RC-VW223	0954
2,8 VR6	128	08.95 - 09.97	AAA	6	Without Coil lead: 01.94>	RC-VW201	0932
2,8	150	01.99 - 05.00	AQP	6		RC-VW244	7358
2,8	150	06.00 - 05.01	AUE	6		RC-VW244	7358
2,8	150	06.01 - 09.03	BDE	6		RC-VW244	7358
2,9	140	11.94 - 09.97	ABV	6		RC-VW201	0932
2,9	140	11.94 - 09.97	ABV	6		RC-VW223	0954
2,9 VR6	140	05.96 - 02.99	ABV	6		RC-VW223	0954

Jetta

1,1	37	08.79 - 07.83	GG	4		RC-VW1102	2569
1,2	77	10.10 -	CBZB	4		RC-VW1110	44316
1,3	40	08.83 - 07.85	HK	4		RC-VW210	0941
1,3	40	08.85 - 07.91	MH	4		RC-VW210	0941
1,3	40	08.85 - 07.91	NZ	4		RC-VW210	0941
1,3	40	08.89 - 07.91	2G	4		RC-VW216	0947
1,3	43	08.83 - 07.86	GT	4		RC-VW210	0941
1,3	44	08.79 - 07.83	GF	4		RC-VW1102	2569
1,5	51	08.79 - 07.83	JB	4		RC-VW1102	2569
1,6	51	08.83 - 07.87	EZ	4		RC-VW210	0941
1,6	51	08.85 - 07.91	PN	4		RC-VW210	0941
1,6	53	08.88 - 07.91	RF	4		RC-VW210	0941
1,6	55	08.80 - 07.81	FR	4		RC-VW1102	2569
1,6	55	08.83 - 07.88	HM	4		RC-VW210	0941
1,6	55	08.85 - 07.91	EZ	4		RC-VW210	0941
1,6	63	08.80 - 07.82	FR	4		RC-VW1102	2569
1,6	81	08.79 - 07.82	EG	4		RC-VW1102	2569
1,6	75	10.05 -	CCSA/BSF/BSE	4		RC-VW249	7015
1,8	62	08.87 - 07.90	RH	4		RC-VW210	0941
1,8	66	08.83 - 07.87	HV	4		RC-VW210	0941
1,8	66	08.83 - 07.88	GX	4		RC-VW210	0941
1,8	66	08.83 - 07.91	GU	4		RC-VW210	0941
1,8	66	08.87 - 07.91	RP	4		RC-VW210	0941
1,8	72	08.88 - 07.91	1P	4		RC-VW210	0941
1,8	82	08.82 - 07.83	DX	4		RC-VW1102	2569
1,8	82	08.83 - 07.87	EV	4		RC-VW210	0941
1,8	82	08.83 - 07.88	GZ	4		RC-VW210	0941
1,8	82	08.86 - 07.91	PB	4		RC-VW210	0941
1,8	82	08.88 - 07.91	PF	4		RC-VW210	0941
1,8	95	08.85 - 07.91	PL	4		RC-VW214	0945
1,8	102	08.85 - 07.91	KR	4		RC-VW214	0945

Käfer / Kaefer

1,2	18	08.48 - 12.53	M5	4		RC-VW217	0948
1,2	22	01.54 - 07.65	M51	4		RC-VW217	0948
1,2	25	08.60 - 07.65	M52	4		RC-VW217	0948
1,2	25	08.65 - 12.79	D	4		RC-VW217	0948
1,3	27	08.65 - 07.70	E	4		RC-VW217	0948



kW

C
y
I

Stock-No.

VOLKSWAGEN**Käfer / Kaefer**

1,3	29	08.65 - 07.70	F	4		RC-VW217	0948
1,3	29	08.70 - 07.75	AC	4		RC-VW217	0948
1,3	32	08.70 - 12.75	AB	4		RC-VW217	0948
1,3	32	08.73 - 07.75	AR	4		RC-VW217	0948
1,5	29	08.66 - 07.70	L	4		RC-VW217	0948
1,5	32	08.66 - 07.70	H	4		RC-VW217	0948
1,6	34	08.70 - 12.77	AF	4		RC-VW217	0948
1,6 Mexico	34	05.73 - 08.92	AF	4		RC-VW217	0948
1,6 Mexico	34	09.92 - 08.03	ACD	4		RC-VW217	0948
1,6	35	08.68 - 07.70	B	4		RC-VW217	0948
1,6	35	08.70 - 07.73	AM	4		RC-VW217	0948
1,6	35	08.73 - 07.74	AH	4		RC-VW217	0948
1,6	37	08.70 - 07.73	AD	4		RC-VW217	0948
1,6	37	08.73 - 12.77	AS	4		RC-VW217	0948
1,6	37	08.73 - 12.77	AJ	4		RC-VW217	0948

LT

2,4	66	12.82 - 07.92	DL	6		RC-VW209	0940
2,4	70	08.88 - 04.96	1E	6		RC-VW209	0940

Lupo

1,0	37	10.98 - 07.05	ALL	4		RC-ST902	7313
1,0	37	05.99 - 07.05	ANV	4		RC-VW907	7302
1,0	37	05.99 - 07.05	AER	4	M4 fitment	RC-ST902	7313
1,0	37	09.98 - 07.05	AHT	4	M4 fitment	RC-ST902	7313
1,0	37	05.99 - 07.05	ALD	4		RC-VW907	7302
1,0	37	06.00 - 07.05	AUC	4	SAE Fitment	RC-ST901	7303
1,4	44	09.00 - 07.05	AUD	4		RC-ST901	7303
1,4	55	09.00 - 04.02	AKQ/APE/ AHW/AUA	4		RC-VW1111	44328
1,4	74	09.00 - 07.05	AFK/AQQ/AUB	4		RC-VW1111	44328
1,6 GTi	92	06.00 -	AVY	4		RC-VW910	7306

New Beetle

1,6	75	09.99 - 10.00	AWH	4		RC-VW254	7044
1,6	75	06.00 -	AYD	4		RC-VW254	7044
1,6	75	06.02 -	BFS	4		RC-VW254	7044
2,0	85	11.98 - 06.00	AQY	4		RC-VW254	7044
2,0	85	07.00 - 06.01	AEG	4		RC-VW254	7044
2,0	85	06.01 - 06.03	APK	4		RC-VW249	7015
2,0	85	01.98 - 10.10	AZG / BEV	4		RC-VW1107	44227

Passat

1,3	40	02.78 - 07.81	FY	4		RC-VW1102	2569
1,3	44	05.73 - 01.78	ZF	4		RC-VW1102	2569
1,3	44	02.78 - 07.79	FZ	4		RC-VW1102	2569
1,3	44	08.79 - 07.82	FY	4		RC-VW1102	2569
1,3	44	08.79 - 07.84	FZ	4	DIN fitment	RC-VW1102	2569
1,3	44	08.80 - 07.86	EP	4		RC-VW210	0941
1,5	55	06.73 - 07.75	ZB	4		RC-VW1102	2569
1,5	55	08.74 - 07.75	YJ	4		RC-VW1102	2569
1,5	63	05.73 - 07.77	ZC	4		RC-VW1102	2569
1,6	53	08.77 - 07.79	FS	4		RC-VW1102	2569
1,6	53	08.86 - 03.88	RL	4		RC-VW210	0941
1,6	53	04.88 - 07.91	1F	4		RC-VW210	0941
1,6	55	05.73 - 07.77	YN	4		RC-VW1102	2569
1,6	55	02.76 - 07.77	FS	4		RC-VW1102	2569
1,6	55	08.77 - 07.81	YN	4	DIN fitment	RC-VW1102	2569
1,6	55	08.81 - 07.84	WV	4	DIN fitment	RC-VW1102	2569



kW

C
y
l

Stock-No.

VOLKSWAGEN**Passat**

1,6	55	08.83 - 03.88	DT	4		RC-VW210	0941
1,6	55	08.83 - 03.88	DT	4	08.83>	RC-VW218	0949
1,6	55	08.85 - 07.86	DT	4	08.84>	RC-VW210	0941
1,6	55	04.88 - 07.91	EZ	4		RC-VW210	0941
1,6	63	08.73 - 12.82	YP	4		RC-VW1102	2569
1,6	74	10.94 - 12.95	AEK	4		RC-VW227	0958
1,6	74	01.96 - 10.96	AFT	4		RC-VW225	0956
1,6	74	01.96 - 10.96	AFT	4		RC-VW227	0958
1,6	74	05.97 - 08.00	AHL	4		RC-VW254	7044
1,6	74	01.99 - 08.00	ARM	4		RC-VW254	7044
1,6	74	07.99 - 08.00	ANA	4		RC-VW254	7044
1,6	75	09.00 - 03.05	ALZ	4		RC-VW249	7015
1,6	75	05.05 -	BSF/BSE	4		RC-VW249	7015
1,8	55	04.88 - 10.96	AAM	4		RC-VW246	7363
1,8	55	04.88 - 10.96	AAM	4		RC-VW210	0941
1,8	64	08.86 - 03.88	RM	4		RC-VW210	0941
1,8	66	08.83 - 03.88	JN	4		RC-VW210	0941
1,8	66	08.84 - 08.89	DS	4		RC-VW210	0941
1,8	66	04.88 - 10.96	ABS	4		RC-VW904	8622
1,8	66	04.88 - 07.91	RP	4		RC-VW210	0941
1,8	66	10.94 - 10.96	ADZ	4		RC-VW905	8623
1,8	79	04.88 - 07.91	PF	4		RC-VW210	0941
1,8	79	04.88 - 07.91	PV	4		RC-VW210	0941
1,8 G60	79	09.89 - 07.93	PG	4		RC-VW210	0941
1,8	82	04.88 - 07.91	PB	4		RC-VW210	0941
1,8	82	04.88 - 07.91	PF	4		RC-VW210	0941
1,8	85	11.96 - 08.00	AFY	4	Semi-Direct	RC-AD1102	2348
1,8	92	11.96 - 08.00	ADR	4	Semi-Direct	RC-AD1102	2348
1,8	92	01.99 - 03.05	APT	4	Semi-Direct	RC-AD1102	2348
1,8	92	01.99 - 08.00	ARG	4	Semi-Direct	RC-AD1102	2348
1,8	102	04.88 - 09.93	KR	4		RC-VW214	0945
1,8 G60	118	09.89 - 07.93	PG	4		RC-VW210	0941
1,8	118	09.89 - 07.92	PG	4		RC-VW210	0941
1,9	85	08.80 - 07.84	WN	5		RC-AD212	0512
2,0	85	08.83 - 07.87	HP	5		RC-AD216	0516
2,0	85	08.83 - 03.88	JS	5		RC-AD216	0516
2,0	85	04.88 - 04.97	2E	4		RC-VW905	8623
2,0	85	08.93 - 04.97	ADY	4		RC-VW246	7363
2,0	85	08.93 - 04.97	AGG	4		RC-VW905	8623
2,0	85	09.00 - 08.05	AZM	4		RC-VW249	7015
2,0	88	09.00 - 03.05	ASU	4		RC-AD201	0501
2,0	100	04.88 - 09.93	9A	4		RC-VW214	0945
2,0	110	01.94 - 10.96	ABF	4		RC-VW239	0970
2,2	88	08.84 - 08.89	JT	5		RC-AD216	0516
2,2	100	01.85 - 03.88	KV	5		RC-AD216	0516
2,3 VR5	110	11.96 - 08.00	AGZ	5		RC-VW235	0966
2,3 VR5	110	05.97 - 08.00	AGZ	5		RC-VW247	7013
2,3 VR5	110	05.97 - 08.00	AGZ	5		RC-VW235	0966
2,8 VR6	128	04.88 - 10.96	AAA	6	With Coil lead: >03.94	RC-VW223	0954
2,8 VR6	128	04.88 - 10.96	AAA	6	Without Coil lead: 01.94>	RC-VW201	0932
2,8 VR6	142	05.97 - 12.98	ACK	6		RC-AD218	0518
2,8	142	01.99 - 08.00	APR	6		RC-AD218	0518
2,8 VR6	142	09.99 - 08.00	AQD	6		RC-AD218	0518
2,8	142	09.00 - 03.05	AMX	6		RC-AD218	0518
2,8	142	05.02 - 05.03	ATQ	6		RC-AD218	0518
2,8	143	05.97 - 08.00	ALG	6		RC-AD218	0518
2,9 VR6	135	08.93 - 04.97	ABV	6		RC-VW223	0954



kW

C
y
l

Stock-No.

VOLKSWAGEN**Polo**

0,9	29	04.75 - 09.81	HA	4		RC-VW1102	2569
1,0	29	10.81 - 10.86	GL	4	M4 fitment	RC-VW215	0946
1,0	29	10.81 - 10.86	GL	4	DIN fitment	RC-VW1102	2569
1,0	29	09.85 - 10.86	GL	4		RC-VW1104	2576
1,0	33	08.85 - 08.94	HZ	4		RC-VW215	0946
1,0	33	08.88 - 09.90	AAK	4		RC-VW215	0946
1,0	33	10.90 - 08.94	AAU	4		RC-VW215	0946
1,0	33	09.94 - 07.96	AEV	4		RC-VW233	0964
1,0	33	08.89 - 07.96	ACM	4		RC-VW208	0939
1,0	37	08.96 - 10.01	AER	4		RC-ST902	7313
1,0	37	08.97 - 08.99	ALL	4		RC-VW233	0964
1,0	37	09.99 - 04.00	ALD	4		RC-VW907	7302
1,0	37	05.00 - 10.01	AUC	4		RC-ST901	7303
1,1	37	04.75 - 07.83	HB	4		RC-VW1102	2569
1,1	44	04.75 - 07.77	HC	4		RC-VW1102	2569
1,2	40	05.11 -	CBZC	4		RC-VW1110	44316
1,2	66	05.11 -	CBZC	4		RC-VW1110	44316
1,2	77	11.09 -	CBZB	4		RC-VW1110	44316
1,3	40	08.83 - 07.84	HK	4		RC-VW215	0946
1,3	40	08.85 - 12.88	MH	4		RC-VW215	0946
1,3	40	09.85 - 08.88	MH	4	M4 fitment	RC-VW215	0946
1,3	40	05.86 - 12.92	NZ	4	M4 fitment	RC-VW215	0946
1,3	40	08.88 - 08.94	2G	4	M4 fitment	RC-VW215	0946
1,3	40	10.90 - 08.94	AAV	4		RC-VW210	0941
1,3	40	09.94 - 07.95	ADX	4		RC-VW210	0941
1,3	43	01.77 - 07.84	HJ	4		RC-VW1102	2569
1,3	44	08.77 - 07.83	HH	4		RC-VW1102	2569
1,3	55	08.83 - 07.89	GK	4		RC-VW210	0941
1,3	55	10.89 - 08.94	3F	4		RC-VW210	0941
1,3 G40	83	08.86 - 08.94	PY	4		RC-VW215	0946
1,3 G40	85	08.86 - 09.90	PY	4		RC-VW215	0946
1,4	40	10.99 - 10.01	AKP	4		RC-VW907	7302
1,4	40	08.95 - 12.99	AEX	4		RC-VW219	0950
1,4	44	08.95 - 12.99	AEX	4		RC-VW219	0950
1,4	44	11.95 - 12.97	AEX	4		RC-VW216	0947
1,4	44	12.97 - 08.99	AKV	4		RC-ST902	7313
1,4	44	01.98 - 08.99	ANX	4		RC-VW216	0947
1,4	44	01.98 - 08.99	APQ	4		RC-VW219	0950
1,4	44	09.99 - 09.01	AKK	4		RC-VW216	0947
1,4	44	09.99 - 04.00	AKK	4		RC-VW907	7302
1,4	44	09.99 - 08.00	ANW	4		RC-ST901	7303
1,4	44	10.99 - 09.01	AUD	4		RC-ST901	7303
1,4	55	10.99 - 01.02	AHW/APE/AUA	4		RC-VW913	44328
1,4	74	04.96 - 08.99	AFH	4		RC-VW232	0963
1,4	74	09.99 - 10.01	AFK	4		RC-VW910	7306
1,4	74	10.99 - 05.02	AUB	4		RC-VW910	7306
1,6	55	09.94 - 07.95	AEA	4		RC-VW210	0941
1,6	55	09.94 - 08.99	AHS	4		RC-VW216	0947
1,6	55	09.94 - 08.99	AEE	4		RC-VW216	0947
1,6	55	11.95 - 09.97	1F	4		RC-VW215	0946
1,6	55	05.96 - 07.98	AEE	4		RC-VW215	0946
1,6	55	05.97 - 07.01	AEE	4		RC-VW210	0941
1,6	55	08.98 - 08.99	ALM	4		RC-VW215	0946
1,6	55	08.98 - 09.01	ALM	4		RC-VW210	0941
1,6	74	11.95 - 08.99	AFT	4		RC-VW225	0956
1,6	74	09.99 - 09.01	AEH	4		RC-VW225	0956
1,6	74	09.99 - 09.01	AKL	4		RC-VW225	0956



kW

C
y
l

Stock-No.

VOLKSWAGEN**Polo**

1,6	74	03.00 - 10.00	APF	4		RC-VW225	0956
1,6	74	06.00 - 09.01	AUR	4		RC-VW225	0956
1,6	88	09.98 - 08.99	AJV	4		RC-VW910	7306
1,6 GTi	92	10.99 - 04.00	ARC/AVY	4		RC-VW1111	44328
1,6 GTi	92	05.00 - 10.01	ARC/AVY	4		RC-VW910	7306
1,8	66	08.98 - 07.01	ADD	4		RC-VW904	8622

Santana

1,6	55	08.81 - 07.83	WV	4	DIN fitment	RC-VW1102	2569
1,6	63	08.81 - 12.82	YP	4		RC-VW1102	2569
1,8	66	01.83 - 02.88	DS	4	DIN fitment	RC-VW1102	2569
1,8	66	03.88 - 04.91	DS	4		RC-VW1102	2569
1,9	85	08.81 - 07.83	WN	5		RC-AD212	0512
2,0	85	08.83 - 12.85	HP	5		RC-AD216	0516
2,0	85	08.83 - 12.85	JS	5		RC-AD216	0516

Scirocco

1,1	37	02.74 - 07.79	FA	4		RC-VW1102	2569
1,3	44	08.79 - 06.83	GF	4		RC-VW1102	2569
1,5	51	08.78 - 06.83	JB	4		RC-VW1101	2565
1,6	63	04.86 - 07.90	RE	4		RC-VW210	0941
1,6	55	08.82 - 07.90	EW	4		RC-VW210	0941
1,6	63	02.74 - 06.83	FR	4		RC-VW1101	2565
1,6 GTi	81	08.76 - 07.79	EG	4		RC-VW1101	2565
1,6	81	08.79 - 06.83	EG	4		RC-VW1101	2565
1,8	66	08.83 - 07.86	EX	4		RC-VW215	0946
1,8 GTi	70	08.83 - 07.84	JH	4		RC-VW1101	2565
1,8	70	08.85 - 07.91	JH	4		RC-VW1101	2565
1,8	82	08.81 - 07.86	DX	4		RC-VW215	0946
1,8	92	01.86 - 07.91	PL	4		RC-VW214	0945
1,8	102	08.83 - 07.90	KR	4		RC-VW214	0945

Sharan

2,0	85	09.95 - 09.10	ADY	4		RC-VW225	0956
2,0	85	09.95 - 09.10	ATM	4		RC-VW249	7015
2,8 VR6	128	09.95 - 05.00	AAA	6		RC-VW201	0932

Touran

1,2	77	05.10 -	CBZB	4		RC-VW1110	44316
1,6	75	07.03 -	BGU/BSF/BSE	4		RC-VW201	0932
2,0	80	02.06 - 05.09	BSX	4		RC-VW1107	44227

Transporter

1,6	37	08.70 - 07.73	AD	4		RC-VW1102	2569
1,6	37	08.73 - 07.77	AS	4		RC-VW1102	2569
1,6	37	05.79 - 12.82	CT	4		RC-VW1102	2569
1,9	44	08.82 - 02.92	DF	4	M4 fitment	RC-VW210	0941
1,9	44	08.82 - 02.92	DF	4	DIN fitment	RC-VW1102	2569
1,9	57	08.82 - 02.92	DG	4	M4 fitment	RC-VW210	0941
1,9	57	08.82 - 02.92	DG	4	DIN fitment	RC-VW1102	2569
2,0	51	08.75 - 04.79	CJ	4		RC-VW1102	2569
2,0	51	08.77 - 04.79	GE	4		RC-VW1102	2569
2,0	51	05.79 - 12.82	CU	4	M4 fitment	RC-VW210	0941
2,0	51	05.79 - 12.82	CU	4	DIN fitment	RC-VW1102	2569
2,0	62	09.90 - 05.00	AAC	4		RC-VW210	0941
2,0	62	08.93 - 05.00	AAC	4	01.91 > 12.93	RC-VW219	0950
2,0	85	11.03 -	AXA	4		RC-VW254	7044
2,1	70	08.85 - 07.92	MV	4	> 02.92	RC-VW1109	44256
2,1	82	08.85 - 07.92	DJ	4		RC-VW210	0941
2,5	81	09.90 - 07.95	AAF	5		RC-VW1108	44253



kW

C
y
I

Stock-No.

VOLKSWAGEN**Transporter**

2,5	81	01.94 - 08.96	ACU	5		RC-VW1108	44253
2,5	81	05.96 - 05.00	ACU	5		RC-VW902	8618
2,5	81	05.96 - 04.03	AEU	5		RC-VW902	8618
2,5	85	05.98 - 05.00	AET	5		RC-VW902	8618
2,8	103	01.96 - 05.00	AES	6		RC-VW1106	6867

Vento

1,4	40	11.91 - 07.98	ABD	4		RC-VW903	8621
1,4	44	11.91 - 07.95	ABD	4		RC-VW903	8621
1,4	44	08.95 - 04.96	AEX	4		RC-VW210	0941
1,6	55	11.91 - 07.95	ABU	4		RC-VW210	0941
1,6	55	07.94 - 07.95	AEA	4		RC-VW216	0947
1,6	55	08.95 - 12.97	AEE	4		RC-VW219	0950
1,6	74	07.94 - 04.96	AEK	4		RC-VW227	0958
1,6	74	05.96 - 07.97	AFT	4		RC-VW225	0956
1,8	55	11.91 - 04.96	AAM	4		RC-VW246	7363
1,8	66	11.91 - 06.94	ABS	4		RC-VW904	8622
1,8	66	07.94 - 07.97	ADZ	4		RC-VW215	0946
2,0	85	11.91 - 06.94	2E	4		RC-VW215	0946
2,0	85	07.94 - 07.95	ADY	4		RC-VW215	0946
2,0	85	08.95 - 07.97	AGG	4		RC-VW215	0946
2,0	85	04.97 - 12.97	AKR	4		RC-VW246	7363
2,8 VR6	120	08.95 - 04.96	AAA	6		RC-VW223	0954
2,8 VR6	120	08.95 - 04.96	AAA	6		RC-VW201	0932
2,8 VR6	128	11.91 - 07.97	AAA	6	With Coil lead: >12.93	RC-VW223	0954
2,8 VR6	128	11.91 - 07.97	AAA	6	Without Coil lead: 01.94>	RC-VW201	0932

VOLVO**240**

2,0	71	10.82 - 08.84	B19A	4		RC-VL612	8891
2,0	76	09.84 - 08.88	B200K	4	DIN fitment	RC-VL1301	2564
2,0	76	09.84 - 08.89	B200K	4	SAE fitment	RC-VL611	8840
2,1 Turbo	114	10.82 - 08.84	B21ET	4	DIN fitment	RC-VL1301	2564
2,1 Turbo	114	10.82 - 08.84	B21ET	4	SAE fitment	RC-VL611	8840
2,3	82	10.82 - 08.84	B23A	4		RC-VL601	8223
2,3	82	10.82 - 08.84	B23A	4		RC-VL1301	2564
2,3	85	09.84 - 12.93	B230F	4		RC-VL602	8226
2,3	85	09.84 - 08.90	B230F	4		RC-VL611	8840
2,3	96	09.84 - 08.88	B230E	4		RC-VL606	8469
2,3	100	10.82 - 08.84	B23E	4		RC-VL601	8223
2,3	100	10.82 - 08.84	B23E	4		RC-VL1301	2564

242

2,1	73	10.74 - 08.78	B21E	4		RC-VL612	8891
2,1	79	08.78 - 09.82	B21A	4		RC-VL1301	2564
2,1	86	01.77 - 08.78	B21E	4		RC-VL612	8891
2,1	90	09.78 - 09.82	B21E	4		RC-VL612	8891
2,1 Turbo	114	11.79 - 09.82	B21ET	4	DIN fitment	RC-VL1301	2564
2,1 Turbo	114	11.79 - 09.82	B21ET	4	SAE fitment	RC-VL611	8840
2,3	82	11.79 - 09.82	B23A	4		RC-VL1301	2564
2,3	100	09.78 - 09.82	B23E	4		RC-VL1301	2564

244

2,0	60	10.74 - 08.78	B19A	4		RC-VL612	8891
2,0	71	09.78 - 09.82	B19A	4		RC-VL612	8891
2,1	71	10.74 - 09.75	B21E	4		RC-VL612	8891
2,1	74	10.75 - 08.78	B21E	4		RC-VL612	8891
2,1	74	09.78 - 09.82	B21A	4		RC-VL612	8891



kW

C
y
l

Stock-No.

VOLVO**244**

2,1	79	09.78 - 07.82	B21A	4		RC-VL1301	2564
2,1	86	01.77 - 08.78	B21E	4		RC-VL612	8891
2,1	90	10.74 - 09.82	B21E	4		RC-VL612	8891
2,1 Turbo	114	09.80 - 09.82	B21ET	4	DIN fitment	RC-VL1301	2564
2,1 Turbo	114	09.80 - 09.82	B21ET	4	SAE fitment	RC-VL611	8840
2,3	82	09.80 - 09.82	B23A	4		RC-VL1301	2564
2,3	100	09.78 - 09.82	B23E	4		RC-VL1301	2564

245

2,0	60	10.74 - 08.78	B19A	4		RC-VL612	8891
2,0	71	09.78 - 09.82	B19A	4		RC-VL612	8891
2,1	74	10.74 - 12.76	B21A	4		RC-VL612	8891
2,1	79	09.79 - 09.82	B21A	4		RC-VL1301	2564
2,1	86	01.77 - 08.78	B21E	4		RC-VL612	8891
2,1	90	09.78 - 09.82	B21E	4		RC-VL612	8891
2,1 Turbo	114	09.80 - 09.82	B21ET	4	DIN fitment	RC-VL1301	2564
2,1 Turbo	114	09.80 - 09.82	B21ET	4	SAE fitment	RC-VL611	8840
2,3	82	09.80 - 09.82	B23A	4		RC-VL1301	2564
2,3	100	09.78 - 09.82	B23E	4		RC-VL1301	2564

262

2,7	92	10.76 - 08.79	B27A	6		RC-VL613	7116
2,8	114	09.80 - 07.82	B28E	6		RC-VL613	7116

264

2,7	92	09.78 - 08.79	B27A	6		RC-VL613	7116
2,7	103	10.74 - 08.78	B27E	6		RC-VL613	7116
2,7	109	09.78 - 08.80	B27E	6		RC-VL613	7116
2,8	95	09.79 - 07.82	B28A	6		RC-VL613	7116
2,8	114	09.80 - 07.82	B28E	6		RC-VL613	7116

265

2,7	92	01.76 - 08.79	B27A	6		RC-VL613	7116
2,7	102	01.76 - 08.78	B27E	6		RC-VL613	7116
2,7	109	09.78 - 08.80	B27E	6		RC-VL613	7116

340

1,4	47	09.82 - 08.89	B1440	4		RC-RN620	8487
1,4	50	09.84 - 08.91	B144E	4		RC-RN620	8487
1,4	52	09.84 - 08.89	B144S	4		RC-RN620	8487
1,7	60	09.84 - 08.91	B172	4		RC-VL616	7172
2,0	68	09.82 - 08.84	B19A	4	DIN fitment	RC-VL1301	2564
2,0	68	09.82 - 08.84	B19A	4	SAE fitment	RC-VL608	8481

343

2,0	71	09.80 - 08.81	B19A	4	DIN fitment	RC-VL1301	2564
2,0	71	09.80 - 08.81	B19A	4	SAE fitment	RC-VL608	8481

345

1,4	47	09.78 - 08.80	B143E	4		RC-RN620	8487
2,0	71	09.80 - 08.82	B19A	4	DIN fitment	RC-VL1301	2564
2,0	71	09.80 - 08.82	B19A	4	SAE fitment	RC-VL608	8481

360

2,0	66	09.82 - 08.84	B19A	4	DIN fitment	RC-VL1301	2564
2,0	66	09.82 - 08.84	B19A	4	SAE fitment	RC-VL608	8481
2,0 GLTI	82	09.84 - 08.89	B200F	4		RC-VL1301	2564
2,0	82	09.84 - 08.88	B200F	4	SAE fitment	RC-VL608	8481
2,0 GLTI	82	09.85 - 08.86	B200F	4	DIN fitment	RC-VL1301	2564
2,0 GLTI	82	09.85 - 08.86	B200F	4	SAE fitment	RC-VL608	8481



kW

C
y
l

Stock-No.

VOLVO**440**

1,6	61	09.91 - 08.97	B16F	4	320mm Coil lead	RC-VL1302	2993
1,6	61	09.91 - 08.97	B16F	4	>12.91	RC-VL607	8472
1,6	61	09.91 - 08.97	B16F	4	530mm Coil lead	RC-VL604	8464
1,7	64	09.88 - 08.92	B18KPD	4		RC-VL607	8472
1,7	70	09.88 - 08.89	B18F	4	320mm Coil lead	RC-VL1302	2993
1,7	70	09.88 - 08.89	B18F	4	320mm Coil lead	RC-VL604	8464
1,7 GLTi	75	09.88 - 08.93	B18FP	4	320mm Coil lead	RC-VL1302	2993
1,7 GLTi	75	09.88 - 08.89	B18EP	4		RC-VL1302	2993
1,7	75	09.88 - 08.89	B18F	4		RC-VL1302	2993
1,7 GLTi	75	09.88 - 08.93	B18FP	4	530mm Coil lead	RC-VL604	8464
1,7 GLTi	75	09.88 - 08.89	B18EP	4		RC-VL604	8464
1,7	75	09.88 - 08.89	B18F	4		RC-VL604	8464
1,7	75	09.91 - 08.92	B18FP	4	320mm Coil lead	RC-VL1302	2993
1,7	75	09.91 - 08.92	B18FP	4	530mm Coil lead	RC-VL604	8464
1,7 GLTi	80	09.88 - 08.89	B18EP	4	320mm Coil lead	RC-VL1302	2993
1,7 GLTi	80	09.88 - 08.89	B18EP	4	530mm Coil lead	RC-VL604	8464
1,7 Turbo	88	09.88 - 04.96	B18FT	4		RC-VL609	8500
1,8	66	09.90 - 08.97	B18U	4	320mm Coil lead	RC-VL1302	2993
1,8	66	09.90 - 08.97	B18U	4	530mm Coil lead	RC-VL604	8464
2,0	80	09.92 - 08.97	B20F	4	320mm Coil lead	RC-VL1302	2993
2,0	80	09.92 - 08.97	B20F	4	530mm Coil lead	RC-VL604	8464

460

1,7	64	09.89 - 08.92	B18KPD	4		RC-VL607	8472
1,7	75	09.89 - 08.93	B18FP	4	320mm Coil lead	RC-VL1302	2993
1,7	75	09.89 - 08.93	B18FP	4	530mm Coil lead	RC-VL604	8464
1,7	75	09.91 - 08.93	B18FP	4		RC-VL1302	2993
1,7	75	09.91 - 08.93	B18FP	4		RC-VL604	8464
1,7 Turbo	88	09.89 - 08.96	B18FT	4		RC-VL609	8500
1,8	66	09.90 - 08.97	B18U	4	320mm Coil lead	RC-VL1302	2993
1,8	66	09.90 - 08.97	B18U	4	530mm Coil lead	RC-VL604	8464
2,0	80	09.92 - 08.97	B20F	4	320mm Coil lead	RC-VL1302	2993
2,0	80	09.92 - 08.97	B20F	4	530mm Coil lead	RC-VL604	8464

480

1,7	75	08.87 - 08.93	B18FP	4		RC-VL604	8464
1,7	80	08.86 - 07.91	B18ES	4	320mm Coil lead	RC-VL1302	2993
1,7	80	08.86 - 07.91	B18E	4	320mm Coil lead	RC-VL1302	2993
1,7	80	08.86 - 07.91	B18ES	4	530mm Coil lead	RC-VL604	8464
1,7	80	08.86 - 07.91	B18E	4	530mm Coil lead	RC-VL604	8464
1,7 Turbo	88	09.85 - 12.95	B18FT	4		RC-VL609	8500
2,0	80	08.92 - 08.95	B20F	4	320mm Coil lead	RC-VL1302	2993
2,0	80	08.92 - 08.95	B20F	4	530mm Coil lead	RC-VL604	8464

740

2,0	82	09.90 - 08.92	B200F	4		RC-VL606	8469
2,0	89	09.87 - 08.92	B200E	4		RC-VL606	8469
2,3	82	08.84 - 10.86	B230A	4		RC-VL1301	2564
2,3	85	09.87 - 08.92	B230F	4		RC-VL606	8469
2,3	89	08.84 - 08.87	B230E	4		RC-VL606	8469
2,3	95	04.83 - 07.84	B23E	4		RC-VL1301	2564
2,3	96	08.84 - 08.87	B230K			RC-VL606	8469
2,3	96	09.87 - 08.91	B230E	4		RC-VL606	8469
2,3	100	08.88 - 07.90	B230FB	4		RC-VL606	8469
2,3	111	09.89 - 08.92	B234F	4		RC-VL606	8469
2,3 Turbo	115	09.87 - 08.91	B230FT	4		RC-VL606	8469
2,3	117	09.87 - 08.90	B234F	4		RC-VL606	8469
2,3 Turbo	121	08.89 - 07.90	B230GT	4		RC-VL606	8469



kW

C
y
l

Stock-No.

VOLVO**740**

2,3 Turbo	125	09.89 - 08.91	B230FT	4		RC-VL606	8469
2,3 Turbo	134	09.87 - 08.90	B230ET	4		RC-VL606	8469
2,3 Turbo	140	08.89 - 07.90	B230FT	4		RC-VL606	8469

760

2,3 Turbo	115	09.87 - 08.90	B230ET	4		RC-VL1301	2564
2,3 Turbo	127	04.82 - 07.84	B23ET	4		RC-VL1301	2564
2,3 Turbo	130	08.84 - 06.86	B230ET	4		RC-VL1301	2564
2,3 Turbo	134	08.84 - 08.87	B230ET	4		RC-VL1301	2564
2,8	95	08.84 - 08.87	B28A	6		RC-VL613	7116
2,8	108	09.87 - 08.90	B280F	6		RC-VL614	7117
2,8	114	04.82 - 07.84	B28E	6		RC-VL613	7116
2,8	114	08.84 - 08.87	B280F	6		RC-VL614	7117

780

2,8	115	09.86 - 08.87	B280E	6		RC-VL614	7117
2,8	125	09.85 - 08.91	B280E	6		RC-VL614	7117

850

2,0	93	09.91 - 10.96	B5202FS	5		RC-VL605	8468
2,0	105	09.91 - 10.96	B5204FS	5		RC-VL1304	6076
2,0 Turbo	155	09.93 - 10.96	B5204FT	5		RC-VL1304	6076
2,3	106	01.96 - 10.96	B5234FS	5		RC-VL1304	6076
2,3 Turbo	166	09.93 - 10.96	B5234FT	5		RC-VL1304	6076
2,3	176	04.96 - 10.96	B5234T2	5		RC-VL1304	6076
2,4	103	09.92 - 10.96	B5252FS	5		RC-VL605	8468
2,4	125	09.91 - 10.97	B5254FS	5		RC-VL1304	6076
2,4	142	09.93 - 10.97	B5254T	5		RC-VL1304	6076

940

2,0	82	09.90 - 12.95	B200F	4		RC-VL606	8469
2,0 Turbo	102	10.93 - 05.97	B204FT	4		RC-VL606	8469
2,0 Turbo	114	09.90 - 05.97	B200FT	4		RC-VL606	8469
2,3	85	09.90 - 09.93	B230F	4		RC-VL606	8469
2,3	96	09.90 - 05.97	B230FK	4		RC-VL606	8469
2,3	96	09.90 - 09.93	B230G	4		RC-VL606	8469
2,3	96	09.90 - 09.93	B230E	4		RC-VL606	8469
2,3	96	10.93 - 05.97	B230FD	4		RC-VL606	8469
2,3	114	09.90 - 08.92	B234F	4		RC-VL606	8469
2,3 Turbo	121	09.90 - 12.95	B230FT	4		RC-VL606	8469

960

2,0 Turbo	140	09.90 - 08.93	B204FT	4		RC-VL606	8469
-----------	-----	---------------	--------	---	--	----------	------

C30

1,6	74	10.06 -	B4164S3	4		RC-FD807	8541
-----	----	---------	---------	---	--	----------	------

C70

2,0	132	09.97 - 09.99	B5204T2	5		RC-VL1304	6076
2,0	132	09.98 - 09.99	B5204T2	5		RC-VL605	8468
2,0	166	06.97 - 08.02	B5204T3	5		RC-VL1304	6076
2,3	177	06.97 - 08.02	B5234T3	5		RC-VL1304	6076

S40

1,6	74	01.05 -	B4164S3	4		RC-FD807	8541
1,6	77	03.96 - 09.99	B4164S	4		RC-RN608	8492
1,6	80	10.99 - 06.04	B4164S2	4	Semi-Direct	RC-VL1305	6304
1,6	80	10.99 - 06.04	B4164S2	4		RC-RN608	8492
1,8	85	11.95 - 09.99	B4184S	4		RC-RN608	8492
1,8	85	06.01 - 08.03	B4184 S2/ S9/S10	4	Semi-Direct	RC-VL1305	6304



kW

C
y
l

Stock-No.

VOLVO**S40**

1,8	90	04.99 - 06.04	B4184S2	4	Semi-Direct	RC-VL1305	6304
1,8	90	04.99 - 06.04	B4184S2	4		RC-RN608	8492
1,8	92	10.99 - 12.00	B4184SM	4		RC-RN608	8492
1,9	147	06.97 - 09.99	B4194T	4	Semi-Direct	RC-VL1305	6304
1,9	147	10.99 - 12.00	B4194T2	4	Semi-Direct	RC-RN608	8492
2,0	100	12.99 - 06.04	B4204S2	4	Semi-Direct	RC-VL1305	6304
2,0	103	11.95 - 12.99	B4204S	4		RC-RN608	8492
2,0	118	06.97 - 09.99	B4204T	4	Semi-Direct	RC-VL1305	6304
2,0	118	06.97 - 09.99	B4204T	4		RC-RN608	8492
2,0	120	12.99 - 06.04	B4204T3	4	Semi-Direct	RC-VL1305	6304
2,0	147	12.99 - 06.04	B4204T5	4	Semi-Direct	RC-VL1305	6304

S70

2,0	93	11.96 - 09.99	B5202FS	5		RC-VL605	8468
2,0	132	11.96 - 09.99	B5204T2	5		RC-VL605	8468
2,0 Turbo	155	11.96 - 09.00	B5204T	5		RC-VL1304	6076
2,0	166	11.96 - 09.00	B5204T3	5		RC-VL1304	6076
2,3	176	11.96 - 09.99	B5234T2	5		RC-VL1304	6076
2,3	177	11.96 - 09.00	B5234T3	5		RC-VL1304	6076
2,3	184	07.97 - 09.00	B5234T4	5		RC-VL1304	6076
2,4	106	11.96 - 06.99	B5252FS	5		RC-VL605	8468
2,4	125	11.96 - 10.98	B5254FS	5		RC-VL1304	6076
2,4	142	11.96 - 09.99	B5254T	5		RC-VL1304	6076
2,4	142	11.96 - 09.99	B5254T	5		RC-VL605	8468

V40

1,6	77	03.96 - 09.99	B4164S	4		RC-RN608	8492
1,6	80	10.99 - 06.04	B4164S2	4	Semi-Direct	RC-VL1305	6304
1,6	80	10.99 - 06.04	B4164S2	4		RC-RN608	8492
1,8	85	03.96 - 09.99	B4184S	4		RC-RN608	8492
1,8	85	10.99 - 12.00	B4184S3	4	Semi-Direct	RC-VL1305	6304
1,8 Blu-Fuel	85	06.01 - 08.03	B4184 S9/S10	4	Semi-Direct	RC-VL1305	6304
1,8	90	04.99 - 06.04	B4184S2	4		RC-RN608	8492
1,8	92	10.99 - 12.00	B4184SM	4		RC-RN608	8492
1,9	147	06.97 - 09.99	B4194T	4	Semi-Direct	RC-VL1305	6304
1,9	147	06.97 - 09.99	B4194T	4		RC-RN608	8492
2,0	103	03.96 - 12.99	B4204S	4		RC-RN608	8492
2,0	118	06.97 - 09.99	B4204T	4	Semi-Direct	RC-VL1305	6304
2,0	118	06.97 - 09.99	B4204T	4		RC-RN608	8492
2,0	120	12.99 - 06.04	B4204T3	4	Semi-Direct	RC-VL1305	6304
2,0	121	10.99 - 09.01	B4204T2	4	Semi-Direct	RC-VL1305	6304
2,0	147	12.99 - 06.04	B4204T5	4	Semi-Direct	RC-VL1305	6304

V50

1,6	74	11.04 -	B4164S3	4		RC-FD807	8541
-----	----	---------	---------	---	--	----------	------

V70

2,0	93	11.96 - 09.00	B5202S	5		RC-VL605	8468
2,0	105	11.96 - 09.00	B5204FS	5		RC-VL1304	6076
2,0	132	11.96 - 11.98	B5204T2	5		RC-VL1304	6076
2,0 Turbo	155	11.96 - 09.00	B5204T	5		RC-VL1304	6076
2,0 Turbo	166	11.96 - 09.00	B5204T3	5		RC-VL1304	6076
2,3	176	11.96 - 08.02	B5234T2	5		RC-VL1304	6076
2,3	177	11.96 - 09.99	B5234T3	5		RC-VL1304	6076
2,3	184	01.97 - 03.00	B5234FT+	5		RC-VL605	8468
2,4	106	11.96 - 06.99	B5252FS	5		RC-VL605	8468
2,4	125	11.96 - 10.98	B5254FS	5		RC-VL1304	6076
2,4	142	11.96 - 09.99	B5254T	5		RC-VL1304	6076
2,4	147	10.97 - 09.99	B5254T	5		RC-VL1304	6076



kW

C
y
l

Stock-No.

WARTBURG**353**

1,0	33	04.66 - 03.69	1A	3		RC-MX1210	4954
1,0	37	04.69 - 03.75	2B	3		RC-MX1210	4954
1,0	37	04.75 - 03.88	2BA	3		RC-MX1210	4954
1,3	43	04.88 - 03.91	GT	4		RC-MX1211	4978

WOLSELEY**Hornet**

1,0	28	10.60 - 08.69	99LFD	4		RC-AT405	0543
-----	----	---------------	-------	---	--	----------	------

YUGO**Sana**

1,4	52	10.89 - 10.93	14FE	4		RC-ST405	0906
-----	----	---------------	------	---	--	----------	------

Tempo

1,3	48	05.91 - 12.93	146A6	4		RC-ST405	0906
-----	----	---------------	-------	---	--	----------	------

Z.A.Z**Tavrija**

1,1	37	01.89 -	MEMZ-245	4		RC-LD302	7104
1,3	44	01.89 -	MEMZ-310	4		RC-LD302	7104
1,3 (Tavrija)	44	04.00 -	VAZ218	4		RC-LD302	7104

ZASTAVA**45**

0,9	33	10.78 - 12.88	10A	4		RC-ST405	0906
-----	----	---------------	-----	---	--	----------	------

55

1,1	41	10.78 - 12.88	11A	4		RC-ST405	0906
-----	----	---------------	-----	---	--	----------	------

65

1,3	46	10.78 - 12.88	13A	4		RC-ST405	0906
-----	----	---------------	-----	---	--	----------	------

101

1,1	40	02.72 - 10.89	128A000	4		RC-LC617	7286
1,1	48	10.79 - 10.84	128AC5000	4		RC-LC617	7286

Erklärung der Zündleitungsbilder
Symbol Explanation Chart
Пояснения
Tabla explicativa de simbolos

Tabela objaśnień
Sembol Açıklama Grafiği
Dichiarazione immagini cavo di accensione
Description des Schémas

Länge der Zündleitungen zu den Zündkerzen
 Length of ignition leads to spark plugs
 Длина свечного провода
 Longitud de los cables de encendido hasta las bujías
 Długość przewodów zapłonowych
 Ateşleme bujisine kadar kablo uzunluđu
 Lunghezza dei cavi di accensione alle candele
 Longueur du câble jusqu'à la bougie

Zylinder 1 bis 6, Zylinder 7 bis 12 optional in zweiter Spalte
 Cylinder 1 to 6, Cylinder 7 to 12 optional in second column
 Цилиндры с 1 по 6, цилиндры с 7 по 12 указываются во второй колонке
 Cilindros del 1 al 6, cilindros del 7 al 12 opcional en columna segunda
 Cylindry 1-6, cylindry 7-12 opcjonalnie w drugiej kolumnie
 Silindir 1 'den 6 'ya, opsiyonlu olarak ikinci sütunda Silindir 6 'dan 12 'ye
 Cilindro 1 fino 6, cilindro 7 fino 12 opzionale nella seconda colonna
 Identification des cylindre 1 à 6, cylindre 6 à 12 en 2ème colonne
 (si nécessaire)

Keine Zündleitung erforderlich
 No requirement for ignition lead
 Провод не требуется
 No requiere cables de encendido
 Ilość potrzebnych przewodów
 Ateşleme kablosuna ihtiyaç yoktur
 Nessun di cavo d'accensione richiesto
 Câble inutile

Jeder Steckertyp wird dargestellt
 Each Plug Type is shown
 Изображение каждого коннектора
 Cada tipo de conector esta mostrado
 Wszystkie typy wtyczek są pokazane
 Her soket tipi gösterilmektedir
 Ogni tipo di connettore è rappresentata
 Identification de chaque capuchon

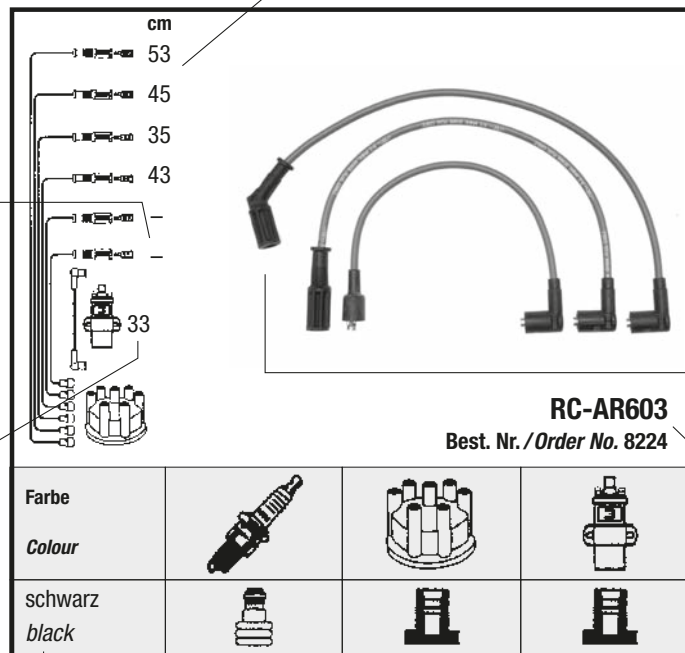

Länge der Leitung Spule - Verteiler (optional)
 Length of ignition lead distributor to coil
 Длина провода "катушка-распределитель"
 Longitud desde el distribuidor a la bobina
 Długość przewodu od cewki do rozdzielacza
 Distribütörden bobine ateşleme kablosu uzunluđu
 Lunghezza cavo della bobina opzionale
 Longueur du câble distributeur/bobine

Artikelbezeichnung und Stock Nr.
 Article Description and Stock Number
 Описание артикула и заказной №
 Descripción del artículo y número de stock
 Numer artykułu i numer zamówieniowy
 Ürün Tanımı ve Stok Numarası
 Descizione numero consistito
 Description de l'article et Numéro de Stock

Farbe der Zündleitung
 Colour of ignition lead
 Цвет провода
 Color del cable de encendido
 Kolor przewodów zapłonowych
 Kablo rengi
 Colore di cavo d'accensione
 Couleur des câbles

Anschlusstyp Zündkerze
 Connector Type Spark Plug
 Тип коннектора свеча зажигания
 Tipo de conector de la bujía
 Typ połączenia na świecy zapłonowej
 Ateşleme bujisi konektör tipi
 Collegamento tipo di candela
 Type de connecteur câble/bougie

Anschlusstyp Verteiler
 Connector Type Distributor
 Тип коннектора распределитель
 Tipo de conector del distribuidor
 Typ połączenia na rozdzielaczu
 Distribütör konektör tipi
 Collegamento tipo distributore
 Type de connecteur câble/distributeur

Anschlusstyp Spule
 Connector Type Coil
 Тип коннектора катушка зажигания
 Tipo de conector de la bobina
 Typ połączenia na cewce zapłonowej
 Ateşleme bobini konektör tipi
 Collegamento tipo bobina
 Type de connecteur câble/bobine



Cable Sets

<p>RC-AD201 Stock-No. 0501</p>				<p>RC-AD202 Stock-No. 0502</p>			
Farbe Colour				Farbe Colour			
schwarz black		—		schwarz black			
<p>RC-AD204 Stock-No. 0504</p>				<p>RC-AD205 Stock-No. 0505</p>			
Farbe Colour				Farbe Colour			
schwarz black		—		schwarz black			
<p>RC-AD206 Stock-No. 0506</p>				<p>RC-AD207 Stock-No. 0507</p>			
Farbe Colour				Farbe Colour			
schwarz black				schwarz black			

		SAE			M4		DIN		FORD COIL		5+7 mm insert
--	--	-----	--	--	----	--	-----	--	-----------	--	---------------

Cable Sets

		<p>RC-AD208 Stock-No. 0508</p>			<p>RC-AD209 Stock-No. 0509</p>		
<p>Farbe Colour</p>				<p>Farbe Colour</p>			
<p>schwarz black</p>				<p>schwarz black</p>			
		<p>RC-AD210 Stock-No. 0510</p>			<p>RC-AD211 Stock-No. 0511</p>		
<p>Farbe Colour</p>				<p>Farbe Colour</p>			
<p>schwarz black</p>				<p>schwarz black</p>			
		<p>RC-AD212 Stock-No. 0512</p>			<p>RC-AD215 Stock-No. 0515</p>		
<p>Farbe Colour</p>				<p>Farbe Colour</p>			
<p>schwarz black</p>				<p>schwarz black</p>			

--	--	--	--	--

Cable Sets

				RC-AD216 Stock-No. 0516					RC-AD218 Stock-No. 0518
Farbe Colour					Farbe Colour				
schwarz black					schwarz black		—		
				RC-AD219 Stock-No. 0519					RC-AD1101 Stock-No. 7709
Farbe Colour					Farbe Colour				
schwarz black					schwarz black				
				RC-AD1102 Stock-No. 2348					RC-AD1103 Stock-No. 2568
Farbe Colour					Farbe Colour				
schwarz black		—			schwarz black				











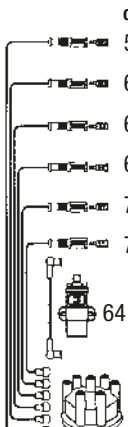

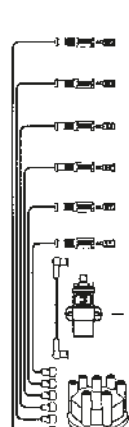











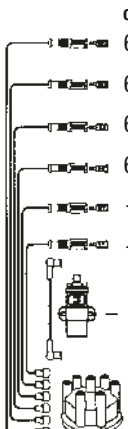

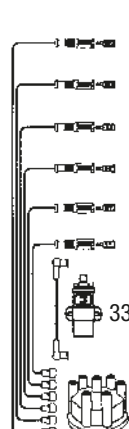











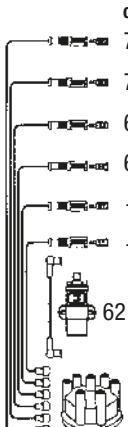

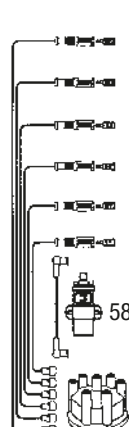



		SAE			M4		DIN		FORD COIL		5+7 mm insert
--	--	------------	--	--	-----------	--	------------	--	------------------	--	----------------------

Cable Sets

<p>RC-AD1104 Stock-No. 2579</p>				<p>RC-AR201 Stock-No. 0520</p>			
Farbe				Farbe			
Colour				Colour			
schwarz				schwarz			
black				black			
<p>RC-AR204 Stock-No. 0523</p>				<p>RC-AR205 Stock-No. 0524</p>			
Farbe				Farbe			
Colour				Colour			
schwarz		—		schwarz			
black				black			
<p>RC-AR403 Stock-No. 0527</p>				<p>RC-AR406 Stock-No. 0530</p>			
Farbe				Farbe			
Colour				Colour			
schwarz				schwarz			
black				black			

SAE	M4	DIN	FORD COIL	5 + 7 mm insert

Cable Sets

<p>cm</p> <p>50 / 72</p> <p>60 / 92</p> <p>60</p> <p>60</p> <p>72</p> <p>72</p> <p>64</p> 	 <p>RC-AR414 Stock-No. 0538</p>			<p>cm</p> <p>64</p> <p>69</p> <p>62</p> <p>53</p> <p>—</p> <p>—</p> 	 <p>RC-AR601 Stock-No. 8194</p>		
<p>Farbe</p> <p>Colour</p>				<p>Farbe</p> <p>Colour</p>			
<p>schwarz</p> <p>black</p>				<p>schwarz</p> <p>black</p>		<p>—</p>	
<p>cm</p> <p>68</p> <p>68</p> <p>68</p> <p>68</p> <p>—</p> <p>—</p> <p>—</p> <p>—</p> 	 <p>RC-AR602 Stock-No. 8195</p>			<p>cm</p> <p>53</p> <p>45</p> <p>35</p> <p>43</p> <p>—</p> <p>—</p> <p>—</p> <p>33</p> 	 <p>RC-AR603 Stock-No. 8224</p>		
<p>Farbe</p> <p>Colour</p>				<p>Farbe</p> <p>Colour</p>			
<p>schwarz</p> <p>black</p>		<p>—</p>		<p>schwarz</p> <p>black</p>			
<p>cm</p> <p>71</p> <p>71</p> <p>63</p> <p>63</p> <p>—</p> <p>—</p> <p>62</p> 	 <p>RC-AR604 Stock-No. 8230</p>			<p>cm</p> <p>80</p> <p>73</p> <p>63</p> <p>58</p> <p>—</p> <p>—</p> <p>—</p> <p>58</p> 	 <p>RC-AR610 Stock-No. 7201</p>		
<p>Farbe</p> <p>Colour</p>				<p>Farbe</p> <p>Colour</p>			
<p>schwarz</p> <p>black</p>				<p>schwarz</p> <p>black</p>			



SAE



M4



DIN

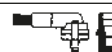

FORD COIL



5+7mm insert

Cable Sets

<p>cm</p> <p>108</p> <p>90</p> <p>79</p> <p>82</p> <p>67</p> <p>54</p> <p>56</p>	<p>RC-AR912 Stock-No. 8629</p>			<p>cm</p> <p>55 / 55</p> <p>62 / 42</p> <p>72</p> <p>82</p> <p>72</p> <p>62</p> <p>54 / 114</p>	<p>RC-AR913 Stock-No. 8630</p>		
<p>Farbe</p> <p>Colour</p>				<p>Farbe</p> <p>Colour</p>			
<p>schwarz</p> <p>black</p>				<p>schwarz</p> <p>black</p>			
<p>cm</p> <p>67</p> <p>55</p> <p>67</p> <p>55</p> <p>—</p> <p>—</p> <p>—</p> <p>—</p> <p>—</p>	<p>RC-AR914 Stock-No. 7307</p>			<p>cm</p> <p>105</p> <p>97</p> <p>93</p> <p>60</p> <p>48</p> <p>32</p> <p>—</p>	<p>RC-AR917 Stock-No. 7312</p>		
<p>Farbe</p> <p>Colour</p>				<p>Farbe</p> <p>Colour</p>			
<p>schwarz</p> <p>black</p>		<p>—</p>		<p>schwarz</p> <p>black</p>		<p>—</p>	
<p>cm</p> <p>60</p> <p>75</p> <p>75</p> <p>85</p> <p>—</p> <p>—</p> <p>60</p>	<p>RC-AR1101 Stock-No. 44235</p>			<p>cm</p> <p>10</p> <p>10</p> <p>10</p> <p>10</p> <p>10</p> <p>—</p> <p>—</p>	<p>RC-AR1102 Stock-No. 44255</p>		
<p>Farbe</p> <p>Colour</p>				<p>Farbe</p> <p>Colour</p>			
<p>schwarz</p> <p>black</p>				<p>schwarz</p> <p>black</p>		<p>—</p>	



SAE



M4



DIN

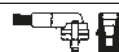

FORD COIL



5+7mm insert

Cable Sets

cm
27
27
29
31
—
—
50

RC-AT402
Stock-No. 0540

cm
23
34
43
56
—
—
55

RC-AT404
Stock-No. 0542

Farbe Colour			
schwarz black			

Farbe Colour			
schwarz black			

cm
30
31
25
26
—
—
30

RC-AT405
Stock-No. 0543

cm
101
86
71
91
—
—

RC-BW205
Stock-No. 0548

Farbe Colour			
schwarz black			

Farbe Colour			
schwarz black		—	

cm
27
32
37
38
—
—
—

RC-BW208
Stock-No. 0551

cm
42
46
56
67
—
—
70

RC-BW210
Stock-No. 0553

Farbe Colour			
schwarz black		—	

Farbe Colour			
schwarz black			

SAE	M4	DIN	FORD COIL	5 + 7 mm insert
------------	-----------	------------	------------------	------------------------

Cable Sets

cm

- 26
- 35
- 47
- 55
-
-
- 77

RC-BW213
Stock-No. 0556

cm

- 54
- 58
- 68
- 78
- 88
- 92
- 64

RC-BW218
Stock-No. 0561

Farbe Colour			
schwarz black			

Farbe Colour			
schwarz black			

cm

- 35
- 45
- 55
- 65
-
-
- 75

RC-BW222
Stock-No. 0565

cm

- 36
- 54
- 54
- 66
- 75
- 83
- 77

RC-BW223
Stock-No. 0567

Farbe Colour			
schwarz black			

Farbe Colour			
schwarz black			

cm

- 115
- 105
- 85
- 110
-
-
-

RC-BW225
Stock-No. 0569

cm

- 46
- 51
- 61
- 71
- 80
- 86
- 76

RC-BW230
Stock-No. 0574

Farbe Colour			
schwarz black		-	

Farbe Colour			
schwarz black			

SAE	M4	DIN	FORD COIL	5+7 mm insert

Cable Sets

cm
44
46
48
54
64

RC-BW231
Stock-No. 0575

cm
93
104
116
118
128
138

RC-BW232
Stock-No. 0576

Farbe Colour			
schwarz black			

Farbe Colour			
schwarz black			

cm
50
55
65
80
90
95

RC-BW233
Stock-No. 0577

cm
24
26
28
33

RC-BW235
Stock-No. 0579

Farbe Colour			
schwarz black			

Farbe Colour			
schwarz black			

cm
57
62
72
82
90
96

RC-BW1101
Stock-No. 2566

cm
45
55
60
75
85
90

RC-BW1104
Stock-No. 44239

Farbe Colour			
schwarz black			

Farbe Colour			
schwarz black			

SAE	M4	DIN	FORD COIL	5 + 7 mm insert
-----	----	-----	-----------	-----------------

Cable Sets

<p>cm</p> <p>45</p> <p>55</p> <p>65</p> <p>75</p> <p>85</p> <p>95</p> <p>55</p>	<p>RC-BW1106 Stock-No. 44243</p>			<p>cm</p> <p>41</p> <p>51</p> <p>61</p> <p>71</p> <p>81</p> <p>91</p> <p>66</p>	<p>RC-BW1108 Stock-No. 44252</p>		
<p>Farbe</p> <p>Colour</p>				<p>Farbe</p> <p>Colour</p>			
<p>schwarz</p> <p>black</p>				<p>schwarz</p> <p>black</p>			
<p>cm</p> <p>38</p> <p>48</p> <p>58</p> <p>68</p> <p>—</p> <p>—</p> <p>28</p>	<p>RC-BW1201 Stock-No. 5503</p>			<p>cm</p> <p>20</p> <p>26</p> <p>38</p> <p>38</p> <p>—</p> <p>—</p> <p>36</p>	<p>RC-CR301 Stock-No. 8283</p>		
<p>Farbe</p> <p>Colour</p>				<p>Farbe</p> <p>Colour</p>			
<p>schwarz</p> <p>black</p>				<p>schwarz</p> <p>black</p>			
<p>cm</p> <p>26</p> <p>29</p> <p>28</p> <p>33</p> <p>43</p> <p>43</p> <p>25</p>	<p>RC-CR302 Stock-No. 8284</p>			<p>cm</p> <p>45</p> <p>56</p> <p>63</p> <p>63</p> <p>66</p> <p>77</p> <p>44 / 44</p>	<p>RC-CR304 Stock-No. 8286</p>		
<p>Farbe</p> <p>Colour</p>				<p>Farbe</p> <p>Colour</p>			
<p>schwarz</p> <p>black</p>				<p>schwarz</p> <p>black</p>			

--	--	--	--	--

Cable Sets

<p>cm 29 44 44 44 59 61 45</p>	<p>RC-CR305 Stock-No. 8287</p>			<p>cm 49 / 78 49 / 80 52 64 70 75 93 / 35</p>	<p>RC-CR306 Stock-No. 8288</p>		
<p>Farbe Colour</p>				<p>Farbe Colour</p>			
<p>schwarz black</p>				<p>schwarz black</p>			
<p>cm 32 32 37 37 34</p>	<p>RC-CR308 Stock-No. 8290</p>			<p>cm 33 29 31 26 33 / 74</p>	<p>RC-CR309 Stock-No. 8292</p>		
<p>Farbe Colour</p>				<p>Farbe Colour</p>			
<p>schwarz black</p>				<p>schwarz black</p>			
<p>cm 22 30 34 24 37</p>	<p>RC-CR310 Stock-No. 8294</p>			<p>cm 38 57 57 71</p>	<p>RC-CR601 Stock-No. 8471</p>		
<p>Farbe Colour</p>				<p>Farbe Colour</p>			
<p>schwarz black</p>				<p>schwarz black</p>		—	

SAE	M4	DIN	FORD COIL	5 + 7 mm insert
------------	-----------	------------	------------------	------------------------

Cable Sets

	<p>RC-CR602 Stock-No. 8480</p>				<p>RC-CR604 Stock-No. 8485</p>		
Farbe Colour				Farbe Colour			
schwarz black		—		schwarz black			
	<p>RC-CR606 Stock-No. 7248</p>				<p>RC-CR1202 Stock-No. 4058</p>		
Farbe Colour				Farbe Colour			
schwarz black				schwarz black		—	
	<p>RC-CR1203 Stock-No. 9170</p>				<p>RC-CR1204 Stock-No. 6864</p>		
Farbe Colour				Farbe Colour			
schwarz black		—		schwarz black		—	



SAE



M4



DIN

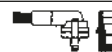

FORD COIL



5+7 mm insert

Cable Sets

<p>RC-CR1301 Stock-No. 44228</p>				<p>RC-CR1302 Stock-No. 44229</p>			
Farbe Colour				Farbe Colour			
schwarz black		—		schwarz black		—	
<p>RC-CT402 Stock-No. 0583</p>				<p>RC-CT405 Stock-No. 0586</p>			
Farbe Colour				Farbe Colour			
schwarz black		—		schwarz black			
<p>RC-CT406 Stock-No. 0566</p>				<p>RC-CT411 Stock-No. 0591</p>			
Farbe Colour				Farbe Colour			
schwarz black				schwarz black			

SAE	M4	DIN	FORD COIL	5 + 7 mm insert
-----	----	-----	-----------	-----------------

Cable Sets

	<p>RC-CT412 Stock-No. 0592</p>				<p>RC-CT601 Stock-No. 7371</p>		
Farbe Colour				Farbe Colour			
schwarz black				schwarz black			
	<p>RC-CT602 Stock-No. 7372</p>				<p>RC-CT603 Stock-No. 7377</p>		
Farbe Colour				Farbe Colour			
schwarz black				schwarz black			
	<p>RC-CT605 Stock-No. 7389</p>				<p>RC-CT611 Stock-No. 7156</p>		
Farbe Colour				Farbe Colour			
schwarz black				schwarz black			

--	--	--	--	--	--

Cable Sets

	<p>RC-CT1306 Stock-No. 44245</p>				<p>RC-DE11 Stock-No. 8921</p>		
Farbe Colour				Farbe Colour			
schwarz black				blau blue			
	<p>RC-DE16 Stock-No. 8091</p>				<p>RC-DE23 Stock-No. 8452</p>		
Farbe Colour				Farbe Colour			
blau blue				blau blue			
	<p>RC-DW301 Stock-No. 8275</p>				<p>RC-DW302 Stock-No. 8276</p>		
Farbe Colour				Farbe Colour			
schwarz black				schwarz black			



SAE



M4



DIN

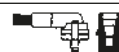

FORD COIL



5+7 mm insert

Cable Sets

		<p>RC-DW304 Stock-No. 7367</p>			<p>RC-DW401 Stock-No. 0593</p>		
<p>Farbe Colour</p>				<p>Farbe Colour</p>			
<p>schwarz black</p>				<p>schwarz black</p>			
		<p>RC-DW402 Stock-No. 0594</p>			<p>RC-DW403 Stock-No. 0595</p>		
<p>Farbe Colour</p>				<p>Farbe Colour</p>			
<p>schwarz black</p>				<p>schwarz black</p>			
		<p>RC-DW1201 Stock-No. 2996</p>			<p>RC-DW1202 Stock-No. 6020</p>		
<p>Farbe Colour</p>				<p>Farbe Colour</p>			
<p>schwarz black</p>				<p>schwarz black</p>			

		<p>SAE</p>		<p>M4</p>		<p>DIN</p>		<p>FORD COIL</p>		<p>5 + 7 mm insert</p>
--	--	------------	--	-----------	--	------------	--	------------------	--	------------------------

	<p>RC-DW1203 Stock-No. 6022</p>		<p>RC-DW1204 Stock-No. 6258</p>				
<p>Farbe Colour</p>				<p>Farbe Colour</p>			
<p>schwarz black</p>		<p>—</p>		<p>schwarz black</p>		<p>—</p>	
	<p>RC-DW1205 Stock-No. 6296</p>		<p>RC-DW1206 Stock-No. 5976</p>				
<p>Farbe Colour</p>				<p>Farbe Colour</p>			
<p>schwarz black</p>		<p>—</p>		<p>schwarz black</p>			
	<p>RC-ED1201 Stock-No. 0348</p>		<p>RC-ED1202 Stock-No. 0350</p>				
<p>Farbe Colour</p>				<p>Farbe Colour</p>			
<p>schwarz black</p>				<p>schwarz black</p>			

	<p>SAE</p>		<p>M4</p>		<p>DIN</p>		<p>FORD COIL</p>		<p>5+7 mm insert</p>
--	------------	--	-----------	--	------------	--	------------------	--	----------------------

Cable Sets

<p>cm 63 52 63 49</p>	<p>RC-ED1203 Stock-No. 5904</p>			<p>cm 60 70</p>	<p>RC-ED1204 Stock-No. 6373</p>		
<p>Farbe Colour</p>				<p>Farbe Colour</p>			
<p>schwarz black</p>				<p>schwarz black</p>		—	
<p>cm 75 75 95 95 95</p>	<p>RC-ED1205 Stock-No. 6871</p>			<p>cm 70 70 60 60</p>	<p>RC-EF1201 Stock-No. 0345</p>		
<p>Farbe Colour</p>				<p>Farbe Colour</p>			
<p>schwarz black</p>				<p>schwarz black</p>		—	
<p>cm 56 63 108 110 55</p>	<p>RC-EF1202 Stock-No. 9166</p>			<p>cm 37 40 51 53 41</p>	<p>RC-EF1203 Stock-No. 9169</p>		
<p>Farbe Colour</p>				<p>Farbe Colour</p>			
<p>schwarz black</p>				<p>schwarz black</p>			

SAE	M4	DIN	FORD COIL	5 + 7 mm insert
------------	-----------	------------	------------------	------------------------

Cable Sets

	<p>RC-EH1201 Stock-No. 9057</p>				<p>RC-EH1202 Stock-No. 6370</p>		
Farbe <i>Colour</i>				Farbe <i>Colour</i>			
schwarz <i>black</i>				schwarz <i>black</i>			
	<p>RC-EM1201 Stock-No. 0346</p>				<p>RC-EM1202 Stock-No. 0347</p>		
Farbe <i>Colour</i>				Farbe <i>Colour</i>			
schwarz <i>black</i>		—		schwarz <i>black</i>		—	
	<p>RC-EM1203 Stock-No. 9120</p>				<p>RC-EM1206 Stock-No. 5900</p>		
Farbe <i>Colour</i>				Farbe <i>Colour</i>			
schwarz <i>black</i>				schwarz <i>black</i>			

		SAE			M4			DIN			FORD COIL			5+7 mm insert
--	--	------------	--	--	-----------	--	--	------------	--	--	------------------	--	--	----------------------

Cable Sets

cm
70
90
110
110
90

RC-EM1207
Stock-No. 5917

cm
38
47
65
75

RC-EM1209
Stock-No. 44260

Farbe Colour			
schwarz black			

Farbe Colour			
schwarz black		—	

cm
17
35

RC-EM1211
Stock-No. 44317

cm
70
65
47
38
18

RC-EN1201
Stock-No. 0349

Farbe Colour			
schwarz black		—	

Farbe Colour			
schwarz black			

cm
65
61
46
43
63

RC-EN1202
Stock-No. 0351

cm
75
63
59
44
32











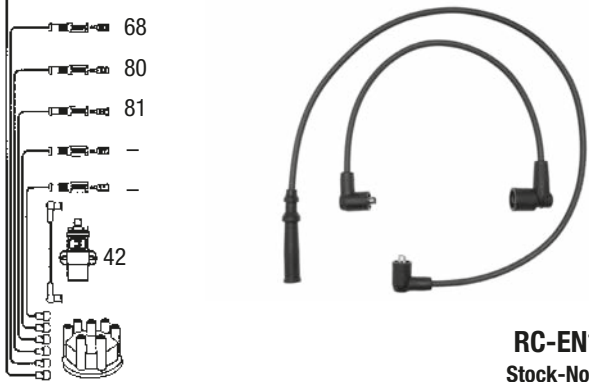
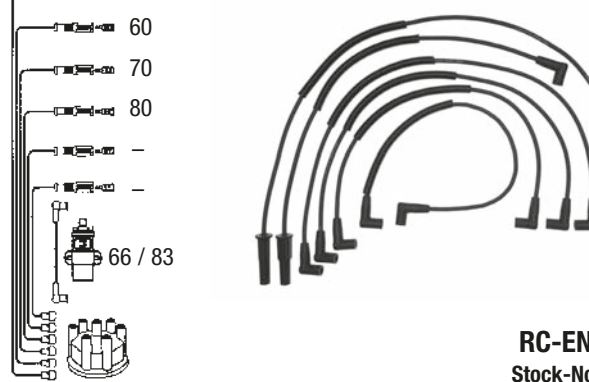











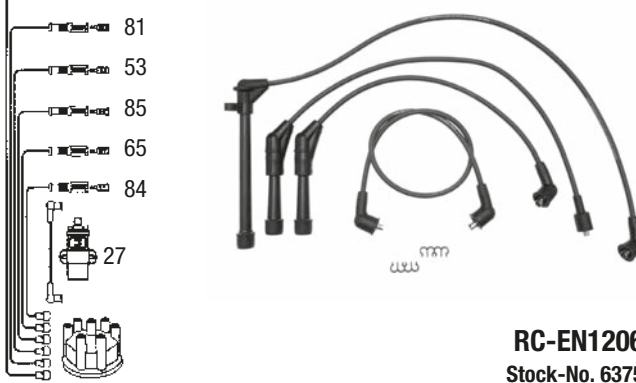
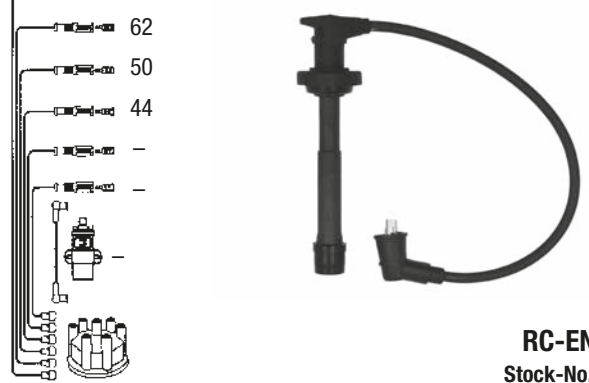











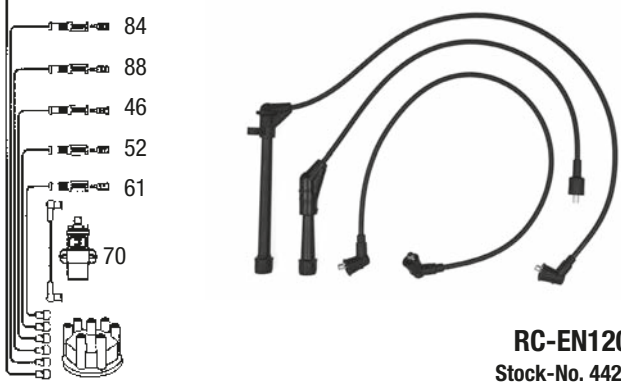
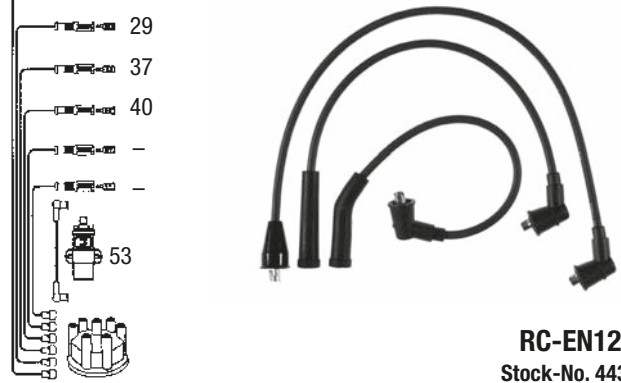

RC-EN1203
Stock-No. 9027

Farbe Colour			
schwarz black			

Farbe Colour			
schwarz black			

SAE	M4	DIN	FORD COIL	5 + 7 mm insert
------------	-----------	------------	------------------	------------------------

Cable Sets

<p>cm</p> <ul style="list-style-type: none"> 65 68 80 81 - - 42 	<p>RC-EN1204 Stock-No. 9163</p>			<p>cm</p> <ul style="list-style-type: none"> 58 60 70 80 - - 66 / 83 	<p>RC-EN1205 Stock-No. 9996</p>		
<p>Farbe Colour</p>				<p>Farbe Colour</p>			
<p>schwarz black</p>				<p>schwarz black</p>			
<p>cm</p> <ul style="list-style-type: none"> 44 81 53 85 65 84 27 	<p>RC-EN1206 Stock-No. 6375</p>			<p>cm</p> <ul style="list-style-type: none"> 68 62 50 44 - - 	<p>RC-EN1208 Stock-No. 44265</p>		
<p>Farbe Colour</p>				<p>Farbe Colour</p>			
<p>schwarz black</p>				<p>schwarz black</p>		<p>—</p>	
<p>cm</p> <ul style="list-style-type: none"> 82 84 88 46 52 61 70 	<p>RC-EN1209 Stock-No. 44268</p>			<p>cm</p> <ul style="list-style-type: none"> 29 29 37 40 - - 53 	<p>RC-EN1210 Stock-No. 44325</p>		
<p>Farbe Colour</p>				<p>Farbe Colour</p>			
<p>schwarz black</p>				<p>schwarz black</p>			

 <p>SAE</p>	 <p>M4</p>	 <p>DIN</p>	 <p>FORD COIL</p>	 <p>5+7 mm insert</p>
--	---	--	---	--

Cable Sets

cm
58
58
70
70
84
84
30

RC-EN1211
Stock-No. 44326

cm
53
55
71
71
—
—
40

RC-ES1201
Stock-No. 0355

Farbe Colour			
schwarz black			

Farbe Colour			
schwarz black			

cm
56
55
50
52
—
—
23

RC-ES1202
Stock-No. 9031

cm
70
60
50
40
—
—

RC-ES1204
Stock-No. 44314

Farbe Colour			
schwarz black			

Farbe Colour			
schwarz black		—	

cm
40
50
55
65
—
—
35

RC-ES1205
Stock-No. 44266

cm
32
15
—
—
—
—

RC-ES1206
Stock-No. 44274

Farbe Colour			
schwarz black			

Farbe Colour			
schwarz black		—	

SAE	M4	DIN	FORD COIL	5 + 7 mm insert
------------	-----------	------------	------------------	------------------------

Cable Sets

<p>cm</p> <p>29</p> <p>44</p> <p>44</p> <p>59</p> <p>—</p> <p>—</p> <p>26</p>	<p>RC-ET1201 Stock-No. 9058</p>			<p>cm</p> <p>60</p> <p>52</p> <p>36</p> <p>42</p> <p>—</p> <p>—</p>	<p>RC-ET1202 Stock-No. 9059</p>		
<p>Farbe</p> <p>Colour</p>				<p>Farbe</p> <p>Colour</p>			
<p>schwarz</p> <p>black</p>				<p>schwarz</p> <p>black</p>		<p>—</p>	
<p>cm</p> <p>35</p> <p>30</p> <p>16</p> <p>18</p> <p>—</p> <p>—</p> <p>62</p>	<p>RC-ET1203 Stock-No. 9072</p>			<p>cm</p> <p>35</p> <p>30</p> <p>16</p> <p>18</p> <p>—</p> <p>—</p> <p>28</p>	<p>RC-ET1204 Stock-No. 9076</p>		
<p>Farbe</p> <p>Colour</p>				<p>Farbe</p> <p>Colour</p>			
<p>schwarz</p> <p>black</p>				<p>schwarz</p> <p>black</p>			
<p>cm</p> <p>78</p> <p>65</p> <p>60</p> <p>47</p> <p>—</p> <p>—</p>	<p>RC-ET1207 Stock-No. 9098</p>			<p>cm</p> <p>76</p> <p>68</p> <p>52</p> <p>47</p> <p>—</p> <p>—</p>	<p>RC-ET1208 Stock-No. 9099</p>		
<p>Farbe</p> <p>Colour</p>				<p>Farbe</p> <p>Colour</p>			
<p>schwarz</p> <p>black</p>		<p>—</p>		<p>schwarz</p> <p>black</p>		<p>—</p>	



SAE



M4



DIN

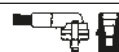

FORD COIL



5+7mm insert

Cable Sets

cm

52

60

60

68

—

—

32

RC-ET1210
Stock-No. 9111

cm

68

70

73

101

101

108

35

RC-ET1211
Stock-No. 9112

Farbe			
Colour			
schwarz			
black			

Farbe			
Colour			
schwarz			
black			

cm

32

32

42

42

42

50

62

RC-ET1212
Stock-No. 9137

cm

34

36

36

85

95

108

31

RC-ET1213
Stock-No. 9150

Farbe			
Colour			
schwarz			
black			

Farbe			
Colour			
schwarz			
black			

cm

49

44

62

67

—

—

—

RC-ET1214
Stock-No. 9167

cm

65

50

48

35

—

—

26











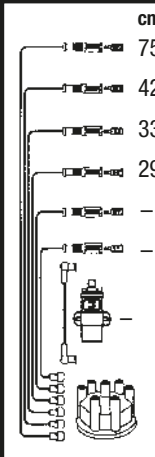

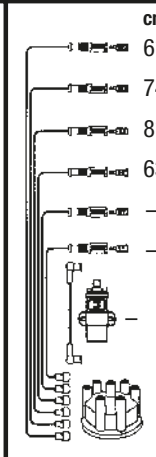











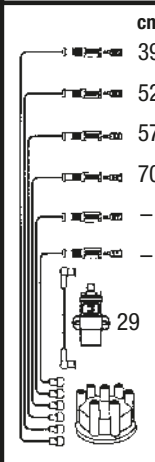

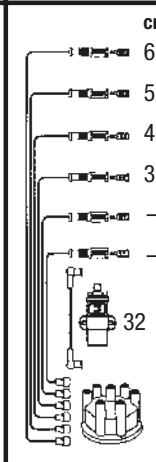













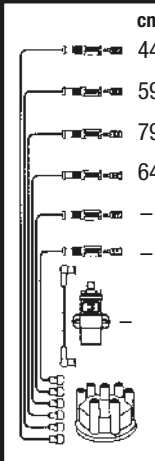

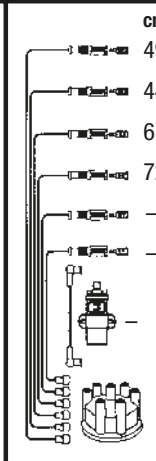

RC-ET1216
Stock-No. 5908

Farbe			
Colour			
schwarz		—	
black			

Farbe			
Colour			
schwarz			
black			

SAE	M4	DIN	FORD COIL	5 + 7 mm insert
------------	-----------	------------	------------------	------------------------

Cable Sets

<p>cm</p> <ul style="list-style-type: none"> 75 42 33 29 - - - - - - 	 <p>RC-ET1217 Stock-No. 5914</p>			<p>cm</p> <ul style="list-style-type: none"> 61 74 81 63 - - - - - - 	 <p>RC-ET1218 Stock-No. 5919</p>		
<p>Farbe Colour</p>				<p>Farbe Colour</p>			
<p>schwarz black</p>		<p>—</p>		<p>schwarz black</p>		<p>—</p>	
<p>cm</p> <ul style="list-style-type: none"> 39.5 52 57 70 - - - - 29 - 	 <p>RC-ET1219 Stock-No. 6367</p>			<p>cm</p> <ul style="list-style-type: none"> 67 52 47 32 - - - - 32 - 	 <p>RC-ET1220 Stock-No. 6369</p>		
<p>Farbe Colour</p>				<p>Farbe Colour</p>			
<p>schwarz black</p>				<p>schwarz black</p>			
<p>cm</p> <ul style="list-style-type: none"> 44 59 79.5 64 - - - - - - 	 <p>RC-ET1222 Stock-No. 44262</p>			<p>cm</p> <ul style="list-style-type: none"> 49 44 61.5 72 - - - - - - 	 <p>RC-ET1223 Stock-No. 44263</p>		
<p>Farbe Colour</p>				<p>Farbe Colour</p>			
<p>schwarz black</p>		<p>—</p>		<p>schwarz black</p>		<p>—</p>	

	<p>SAE</p>		<p>M4</p>		<p>DIN</p>		<p>FORD COIL</p>		<p>5+7mm insert</p>
---	------------	---	-----------	---	------------	--	------------------	---	---------------------

Cable Sets

<p>cm 38 48 60 66 78 92 41</p> <p>RC-ET1227 Stock-No. 44319</p>	<p>cm 33 46 49 64 24</p> <p>RC-ET1228 Stock-No. 44320</p>
<p>Farbe Colour</p>	<p>Farbe Colour</p>
<p>schwarz black</p>	<p>schwarz black</p>
<p>cm 44 47 56 76</p> <p>RC-ET1229 Stock-No. 44321</p>	<p>cm 64 58 46 42 57</p> <p>RC-ET1301 Stock-No. 9171</p>
<p>Farbe Colour</p>	<p>Farbe Colour</p>
<p>schwarz black</p>	<p>schwarz black</p>
<p>cm 52 20</p> <p>RC-EZ1201 Stock-No. 0352</p>	<p>cm 63 57 45 41</p> <p>RC-EZ1202 Stock-No. 0353</p>
<p>Farbe Colour</p>	<p>Farbe Colour</p>
<p>schwarz black</p>	<p>schwarz black</p>

<p>SAE</p>	<p>M4</p>	<p>DIN</p>	<p>FORD COIL</p>	<p>5 + 7 mm insert</p>
------------	-----------	------------	------------------	------------------------

Cable Sets

	<p>RC-EZ1208 Stock-No. 9133</p>				<p>RC-EZ1209 Stock-No. 5945</p>		
Farbe Colour				Farbe Colour			
schwarz black				schwarz black			
	<p>RC-EZ1210 Stock-No. 5903</p>				<p>RC-EZ1211 Stock-No. 6365</p>		
Farbe Colour				Farbe Colour			
schwarz black				schwarz black			
	<p>RC-EZ1214 Stock-No. 44271</p>				<p>RC-EZ1215 Stock-No. 44273</p>		
Farbe Colour				Farbe Colour			
schwarz black				schwarz black			



SAE



M4



DIN

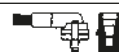

FORD COIL



5+7 mm insert

Cable Sets

		<p>RC-EZ1216 Stock-No. 44318</p>			<p>RC-FD503 Stock-No. 0598</p>		
<p>Farbe Colour</p>				<p>Farbe Colour</p>			
<p>schwarz black</p>		<p>—</p>		<p>schwarz black</p>		<p>—</p>	
		<p>RC-FD508 Stock-No. 0603</p>			<p>RC-FD509 Stock-No. 0604</p>		
<p>Farbe Colour</p>				<p>Farbe Colour</p>			
<p>schwarz black</p>				<p>schwarz black</p>			
		<p>RC-FD519 Stock-No. 0614</p>			<p>RC-FD520 Stock-No. 0615</p>		
<p>Farbe Colour</p>				<p>Farbe Colour</p>			
<p>schwarz black</p>				<p>schwarz black</p>			

		<p>SAE</p>		<p>M4</p>		<p>DIN</p>		<p>FORD COIL</p>		<p>5 + 7 mm insert</p>
--	--	------------	--	-----------	--	------------	--	------------------	--	------------------------

Cable Sets

<p>cm 45 52 54 67 59</p>	<p>RC-FD521 Stock-No. 0616</p>			<p>cm 47 52 57 57 62 67 42 / 87</p>	<p>RC-FD530 Stock-No. 0625</p>		
<p>Farbe Colour</p>				<p>Farbe Colour</p>			
<p>schwarz black</p>				<p>schwarz black</p>			
<p>cm 60 60 80 90 60</p>	<p>RC-FD532 Stock-No. 0627</p>			<p>cm 57 62 67 75 47</p>	<p>RC-FD533 Stock-No. 0628</p>		
<p>Farbe Colour</p>				<p>Farbe Colour</p>			
<p>schwarz black</p>				<p>schwarz black</p>			
<p>cm 37 44 68 54 79 94</p>	<p>RC-FD536 Stock-No. 0631</p>			<p>cm 74 63 47 39</p>	<p>RC-FD537 Stock-No. 0632</p>		
<p>Farbe Colour</p>				<p>Farbe Colour</p>			
<p>schwarz black</p>		—		<p>schwarz black</p>		—	



SAE



M4



DIN

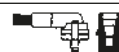

FORD COIL



5+7 mm insert

Cable Sets

<p>RC-FD538 Stock-No. 0633</p>				<p>RC-FD544 Stock-No. 0639</p>			
Farbe Colour				Farbe Colour			
schwarz black		—		schwarz black		—	
<p>RC-FD545 Stock-No. 0640</p>				<p>RC-FD546 Stock-No. 0641</p>			
Farbe Colour				Farbe Colour			
schwarz black		—		schwarz black		—	
<p>RC-FD548 Stock-No. 0642</p>				<p>RC-FD803 Stock-No. 8536</p>			
Farbe Colour				Farbe Colour			
schwarz black		—		schwarz black			

SAE	M4	DIN	FORD COIL	5 + 7 mm insert
------------	-----------	------------	------------------	------------------------

Cable Sets

<p>cm 56 61 66 72 54</p>	<p>RC-FD804 Stock-No. 8537</p>			<p>cm 18 22 36 40</p>	<p>RC-FD807 Stock-No. 8541</p>		
<p>Farbe Colour</p>				<p>Farbe Colour</p>			
<p>schwarz black</p>				<p>schwarz black</p>		—	
<p>cm 48 43 35 21</p>	<p>RC-FD808 Stock-No. 8542</p>			<p>cm 52 60 60 74 70</p>	<p>RC-FD813 Stock-No. 8552</p>		
<p>Farbe Colour</p>				<p>Farbe Colour</p>			
<p>schwarz black</p>		—		<p>schwarz black</p>			
<p>cm 47 55 70 80</p>	<p>RC-FD817 Stock-No. 8556</p>			<p>cm 47 47 47 57 62 72 62 / 62</p>	<p>RC-FD820 Stock-No. 8562</p>		
<p>Farbe Colour</p>				<p>Farbe Colour</p>			
<p>schwarz black</p>				<p>schwarz black</p>			

		SAE			M4		DIN		FORD COIL		5+7 mm insert
--	--	------------	--	--	-----------	--	------------	--	------------------	--	----------------------

Cable Sets

		<p>RC-FD824 Stock-No. 8568</p>			<p>RC-FD825 Stock-No. 8569</p>		
<p>Farbe Colour</p>				<p>Farbe Colour</p>			
<p>schwarz black</p>				<p>schwarz black</p>			
		<p>RC-FD826 Stock-No. 8571</p>			<p>RC-FD830 Stock-No. 7406</p>		
<p>Farbe Colour</p>				<p>Farbe Colour</p>			
<p>schwarz black</p>		<p>—</p>		<p>schwarz black</p>			
		<p>RC-FD901 Stock-No. 8589</p>			<p>RC-FD1201 Stock-No. 5402</p>		
<p>Farbe Colour</p>				<p>Farbe Colour</p>			
<p>schwarz black</p>				<p>schwarz black</p>			

		<p>SAE</p>		<p>M4</p>		<p>DIN</p>		<p>FORD COIL</p>		<p>5 + 7 mm insert</p>
--	--	------------	--	-----------	--	------------	--	------------------	--	------------------------

Cable Sets

<p>cm 50 59 68 68 72 77 23</p>	<p>RC-FD1202 Stock-No. 5403</p>			<p>cm 34 17</p>	<p>RC-FD1203 Stock-No. 5405</p>		
<p>Farbe Colour</p>				<p>Farbe Colour</p>			
<p>schwarz black</p>				<p>schwarz black</p>		—	
<p>cm 46 36 46 81 101 111</p>	<p>RC-FD1204 Stock-No. 7701</p>			<p>cm 75 80 100 95</p>	<p>RC-FD1205 Stock-No. 2584</p>		
<p>Farbe Colour</p>				<p>Farbe Colour</p>			
<p>schwarz black</p>		—		<p>schwarz black</p>		—	
<p>cm 54 41 33 20</p>	<p>RC-FD1207 Stock-No. 6984</p>			<p>cm 60 70 90 85 66</p>	<p>RC-FD1208 Stock-No. 4062</p>		
<p>Farbe Colour</p>				<p>Farbe Colour</p>			
<p>schwarz black</p>		—		<p>schwarz black</p>			



SAE



M4



DIN

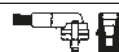

FORD COIL



5+7mm insert

Cable Sets

		<p>RC-FD1209 Stock-No. 4063</p>			<p>RC-FD1210 Stock-No. 6317</p>		
<p>Farbe Colour</p>				<p>Farbe Colour</p>			
<p>schwarz black</p>		<p>—</p>		<p>schwarz black</p>		<p>—</p>	
		<p>RC-FD1211 Stock-No. 1644</p>			<p>RC-FD1212 Stock-No. 44220</p>		
<p>Farbe Colour</p>				<p>Farbe Colour</p>			
<p>schwarz black</p>		<p>—</p>		<p>schwarz black</p>		<p>—</p>	
		<p>RC-FD1213 Stock-No. 44222</p>			<p>RC-FD1214 Stock-No. 44226</p>		
<p>Farbe Colour</p>				<p>Farbe Colour</p>			
<p>schwarz black</p>		<p>—</p>		<p>schwarz black</p>		<p>—</p>	

		<p>SAE</p>			<p>M4</p>		<p>DIN</p>			<p>FORD COIL</p>		<p>5 + 7 mm insert</p>
--	--	------------	--	--	-----------	--	------------	--	--	------------------	--	------------------------

Cable Sets

		<p>RC-FD1215 Stock-No. 44233</p>			<p>RC-FD1216 Stock-No. 44234</p>		
<p>Farbe Colour</p>				<p>Farbe Colour</p>			
<p>schwarz black</p>		<p>—</p>		<p>schwarz black</p>		<p>—</p>	
		<p>RC-FD1217 Stock-No. 44250</p>			<p>RC-FE21 Stock-No. 8793</p>		
<p>Farbe Colour</p>				<p>Farbe Colour</p>			
<p>schwarz black</p>		<p>—</p>		<p>blau blue</p>			
		<p>RC-FE22 Stock-No. 8086</p>			<p>RC-FE25 Stock-No. 8380</p>		
<p>Farbe Colour</p>				<p>Farbe Colour</p>			
<p>blau blue</p>				<p>blau blue</p>			

		<p>SAE</p>			<p>M4</p>			<p>DIN</p>			<p>FORD COIL</p>			<p>5+7 mm insert</p>
--	--	------------	--	--	-----------	--	--	------------	--	--	------------------	--	--	----------------------

Cable Sets

cm
53
49
37
—
—
—
—
52

RC-FE30
Stock-No. 8612

cm
60
68
60
72
—
—
—
—

RC-FE39
Stock-No. 2478

Farbe Colour			
blau blue			

Farbe Colour			
blau blue		—	

cm
52
49
41
27
—
—
—
—

RC-FT201
Stock-No. 0643

cm
24
21
28
41
—
—
—
—

RC-FT202
Stock-No. 0644

Farbe Colour			
schwarz black		—	

Farbe Colour			
schwarz black		—	

cm
30
45
55
65
—
—
—
—

RC-FT203
Stock-No. 0645

cm
61
61
—
—
—
—
—
—

RC-FT414
Stock-No. 0660

Farbe Colour			
schwarz black		—	

Farbe Colour			
schwarz black		—	

SAE	M4	DIN	FORD COIL	5 + 7 mm insert
-----	----	-----	-----------	-----------------

Cable Sets

<p>cm 29 31 38 48 50</p>	<p>RC-FT415 Stock-No. 0661</p>			<p>cm 29 31 38 48 28</p>	<p>RC-FT417 Stock-No. 0664</p>		
<p>Farbe Colour</p>				<p>Farbe Colour</p>			
<p>schwarz black</p>				<p>schwarz black</p>			
<p>cm 30 40 50 60</p>	<p>RC-FT418 Stock-No. 0665</p>			<p>cm 70 60 50 40</p>	<p>RC-FT420 Stock-No. 0667</p>		
<p>Farbe Colour</p>				<p>Farbe Colour</p>			
<p>schwarz black</p>				<p>schwarz black</p>			
<p>cm 70 70</p>	<p>RC-FT428 Stock-No. 0675</p>			<p>cm 50 60 70 80 60</p>	<p>RC-FT431 Stock-No. 0678</p>		
<p>Farbe Colour</p>				<p>Farbe Colour</p>			
<p>schwarz black</p>				<p>schwarz black</p>			

		SAE			M4			DIN			FORD COIL			5+7 mm insert
--	--	------------	--	--	-----------	--	--	------------	--	--	------------------	--	--	----------------------

Cable Sets

		<p>RC-FT435 Stock-No. 0682</p>			<p>RC-FT442 Stock-No. 0689</p>		
<p>Farbe Colour</p>				<p>Farbe Colour</p>			
<p>schwarz black</p>				<p>schwarz black</p>			
		<p>RC-FT444 Stock-No. 0691</p>			<p>RC-FT446 Stock-No. 0693</p>		
<p>Farbe Colour</p>				<p>Farbe Colour</p>			
<p>schwarz black</p>				<p>schwarz black</p>			
		<p>RC-FT454 Stock-No. 0701</p>			<p>RC-FT601 Stock-No. 8192</p>		
<p>Farbe Colour</p>				<p>Farbe Colour</p>			
<p>schwarz black</p>				<p>schwarz black</p>			

		<p>SAE</p>		<p>M4</p>		<p>DIN</p>		<p>FORD COIL</p>		<p>5 + 7 mm insert</p>
--	--	------------	--	-----------	--	------------	--	------------------	--	------------------------

Cable Sets

<p>cm</p> <p>30</p> <p>38</p> <p>49</p> <p>63</p> <p>—</p> <p>—</p> <p>—</p>	<p>RC-FT602 Stock-No. 8193</p>			<p>cm</p> <p>69</p> <p>58</p> <p>57</p> <p>44</p> <p>—</p> <p>—</p> <p>26</p>	<p>RC-FT603 Stock-No. 8202</p>		
<p>Farbe</p> <p>Colour</p>				<p>Farbe</p> <p>Colour</p>			
<p>schwarz</p> <p>black</p>		<p>—</p>		<p>schwarz</p> <p>black</p>			
<p>cm</p> <p>36</p> <p>34</p> <p>27</p> <p>18</p> <p>—</p> <p>—</p> <p>—</p>	<p>RC-FT604 Stock-No. 8205</p>			<p>cm</p> <p>43</p> <p>46</p> <p>57</p> <p>64</p> <p>—</p> <p>—</p> <p>26</p>	<p>RC-FT605 Stock-No. 8206</p>		
<p>Farbe</p> <p>Colour</p>				<p>Farbe</p> <p>Colour</p>			
<p>schwarz</p> <p>black</p>		<p>—</p>		<p>schwarz</p> <p>black</p>			
<p>cm</p> <p>40</p> <p>38</p> <p>31</p> <p>20</p> <p>—</p> <p>—</p> <p>—</p>	<p>RC-FT607 Stock-No. 8208</p>			<p>cm</p> <p>29</p> <p>37</p> <p>55</p> <p>61</p> <p>—</p> <p>—</p> <p>35</p>	<p>RC-FT608 Stock-No. 8210</p>		
<p>Farbe</p> <p>Colour</p>				<p>Farbe</p> <p>Colour</p>			
<p>schwarz</p> <p>black</p>		<p>—</p>		<p>schwarz</p> <p>black</p>			



SAE



M4



DIN

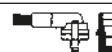

FORD COIL



5+7 mm insert

Cable Sets

cm
52
61
22
33
—
—
25

RC-FT609
Stock-No. 8211

cm
32
26
26
34
—
—
35

RC-FT615
Stock-No. 8218

Farbe Colour			
schwarz black			

Farbe Colour			
schwarz black			

cm
56
54
56
60
—
—

RC-FT618
Stock-No. 8248

cm
30
30
—
—
—
—

RC-FT620
Stock-No. 8503

Farbe Colour			
schwarz black		—	

Farbe Colour			
schwarz black		—	

cm
40
48
62
70
—
—
52

RC-FT621
Stock-No. 8523

cm
65
60
50
40
—
—











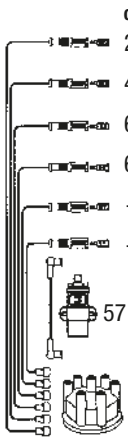

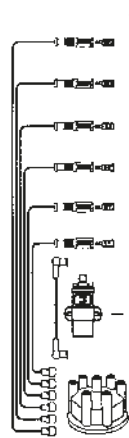











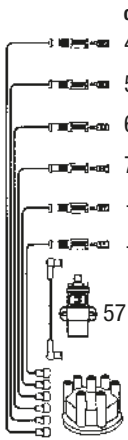

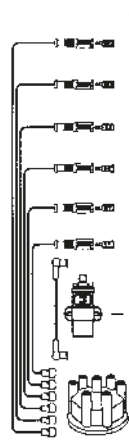











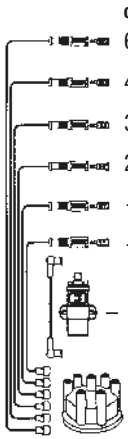

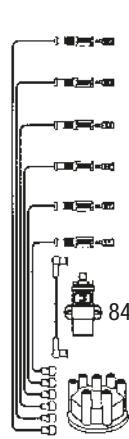

RC-FT623
Stock-No. 7381

Farbe Colour			
schwarz black			

Farbe Colour			
schwarz black		—	

SAE	M4	DIN	FORD COIL	5 + 7 mm insert
------------	-----------	------------	------------------	------------------------

Cable Sets

<p>cm</p> <ul style="list-style-type: none"> 25 47 62 67 — — 57 	 <p>RC-FT624 Stock-No. 3666</p>	<p>cm</p> <ul style="list-style-type: none"> 65 47 38 32 — — 	 <p>RC-FT628 Stock-No. 7171</p>				
<p>Farbe Colour</p>				<p>Farbe Colour</p>			
<p>schwarz black</p>				<p>schwarz black</p>		<p>—</p>	
<p>cm</p> <ul style="list-style-type: none"> 47 57 67 77 — — 57 	 <p>RC-FT631 Stock-No. 7203</p>	<p>cm</p> <ul style="list-style-type: none"> 47 37 27 20 — — 	 <p>RC-FT632 Stock-No. 7209</p>				
<p>Farbe Colour</p>				<p>Farbe Colour</p>			
<p>schwarz black</p>				<p>schwarz black</p>		<p>—</p>	
<p>cm</p> <ul style="list-style-type: none"> 60 46 32 28 — — — 	 <p>RC-FT633 Stock-No. 7211</p>	<p>cm</p> <ul style="list-style-type: none"> 25 29 45 51 — — 84 	 <p>RC-FT634 Stock-No. 7242</p>				
<p>Farbe Colour</p>				<p>Farbe Colour</p>			
<p>schwarz black</p>		<p>—</p>		<p>schwarz black</p>			



SAE



M4



DIN

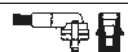

FORD COIL



5+7 mm insert

Cable Sets

	<p>RC-FT635 Stock-No. 7244</p>		<p>RC-FT636 Stock-No. 7205</p>				
Farbe <i>Colour</i>				Farbe <i>Colour</i>			
schwarz <i>black</i>				schwarz <i>black</i>			
	<p>RC-FT638 Stock-No. 7291</p>		<p>RC-FT1101 Stock-No. 44236</p>				
Farbe <i>Colour</i>				Farbe <i>Colour</i>			
schwarz <i>black</i>				schwarz <i>black</i>			
	<p>RC-FT1201 Stock-No. 5407</p>		<p>RC-FT1202 Stock-No. 2571</p>				
Farbe <i>Colour</i>				Farbe <i>Colour</i>			
schwarz <i>black</i>		—		schwarz <i>black</i>		—	

--	--	--	--	--

Cable Sets

				RC-FT1203 Stock-No. 2995					RC-FT1204 Stock-No. 6969
Farbe Colour					Farbe Colour				
schwarz black		—			schwarz black				
				RC-FT1205 Stock-No. 6980					RC-FT1206 Stock-No. 5504
Farbe Colour					Farbe Colour				
schwarz black					schwarz black		—		
				RC-FT1207 Stock-No. 5607					RC-FT1208 Stock-No. 9262
Farbe Colour					Farbe Colour				
schwarz black		—			schwarz black		—		

		SAE			M4		DIN		FORD COIL		5+7 mm insert
--	--	------------	--	--	-----------	--	------------	--	------------------	--	----------------------

Cable Sets

cm
19
19
16
16
—
—
—
—
—
—
—
—

RC-FT1209
Stock-No. 4746

cm
77.5
92.5
102.5
105.5
—
—
—
—
—
—
—
—

RC-FT1301
Stock-No. 44259

Farbe Colour			
schwarz black		—	

Farbe Colour			
schwarz black		—	

cm
62
58
62
66
—
—
—
—
—
—
—
—

RC-FX31
Stock-No. 8456

cm
62
62
62
62
—
—
—
—
—
—
—
—

RC-FX41
Stock-No. 5046

Farbe Colour			
blau blue		—	

Farbe Colour			
blau blue		—	

cm
62
68
62
68
—
—
—
—
—
—
—
—

RC-FX49
Stock-No. 2506

cm
74
40
74
40
—
—
—
—
—
—
—
—

RC-FX51
Stock-No. 5761

Farbe Colour			
blau blue		—	

Farbe Colour			
blau blue		—	

SAE	M4	DIN	FORD COIL	5 + 7 mm insert
-----	----	-----	-----------	-----------------

Cable Sets

<p>cm 59 61 61 64</p>	<p>RC-FX54 Stock-No. 2507</p>			<p>cm 44 60 47 60</p>	<p>RC-FX67 Stock-No. 6856</p>		
<p>Farbe Colour</p>				<p>Farbe Colour</p>			
<p>blau blue</p>		—		<p>blau blue</p>		—	
<p>cm 21 23.5 34.5 41.5 26</p>	<p>RC-GM1101 Stock-No. 9194</p>			<p>cm 38 38 44 48</p>	<p>RC-GM1201 Stock-No. 9185</p>		
<p>Farbe Colour</p>				<p>Farbe Colour</p>			
<p>schwarz black</p>				<p>schwarz black</p>		—	
<p>cm 32 32 32 32 42</p>	<p>RC-GM1202 Stock-No. 5557</p>			<p>cm 27 40 46 53</p>	<p>RC-GM1203 Stock-No. 44277</p>		
<p>Farbe Colour</p>				<p>Farbe Colour</p>			
<p>schwarz black</p>				<p>schwarz black</p>		—	

		SAE			M4			DIN			FORD COIL			5+7mm insert
--	--	------------	--	--	-----------	--	--	------------	--	--	------------------	--	--	---------------------

Cable Sets

cm
32
42
47
60
—
—
50

RC-HD301
Stock-No. 8300

cm
50
60
70
40
50
50
40

RC-HD404
Stock-No. 0706

Farbe Colour			
schwarz black			

Farbe Colour			
schwarz black			

cm
62
49
40
32
—
—

RC-HD407
Stock-No. 0709

cm
57
69
66
75
—
—
42

RC-HD408
Stock-No. 0710

Farbe Colour			
schwarz black		—	

Farbe Colour			
schwarz black			

cm
38
56
70
63
—
—

RC-HD409
Stock-No. 0711

cm
59
70
70
85
—
—
15

RC-HD411
Stock-No. 0713

Farbe Colour			
schwarz black		—	

Farbe Colour			
schwarz black			

SAE	M4	DIN	FORD COIL	5 + 7 mm insert
------------	-----------	------------	------------------	------------------------

Cable Sets

	<p>RC-HD1201 Stock-No. 2570</p>				<p>RC-HD1202 Stock-No. 5506</p>		
Farbe Colour				Farbe Colour			
schwarz black		—		schwarz black		—	
	<p>RC-HD1203 Stock-No. 6206</p>				<p>RC-HD1204 Stock-No. 6301</p>		
Farbe Colour				Farbe Colour			
schwarz black				schwarz black		—	
	<p>RC-HD1205 Stock-No. 6302</p>				<p>RC-HE32 Stock-No. 9105</p>		
Farbe Colour				Farbe Colour			
schwarz black		—		blau blue			

		SAE			M4			DIN			FORD COIL			5+7 mm insert
--	--	-----	--	--	----	--	--	-----	--	--	-----------	--	--	---------------

Cable Sets

cm
68
62
60
54
—
—
46

RC-HE33
Stock-No. 9107

cm
64
58
44
38
—
—

RC-HE53
Stock-No. 8573

Farbe Colour			
blau blue			

Farbe Colour			
blau blue		—	

cm
71
59
57
43
—
—

RC-HE57
Stock-No. 8610

cm
70
58
50
34
—
—

RC-HE64
Stock-No. 8246

Farbe Colour			
blau blue		—	

Farbe Colour			
blau blue		—	

cm
63
59
45
39
25
—
60

RC-HE68A
Stock-No. 5047

cm
66
60
44
38
—
—

RC-HE71
Stock-No. 8650

Farbe Colour			
blau blue			

Farbe Colour			
blau blue		—	

SAE	M4	DIN	FORD COIL	5 + 7 mm insert
------------	-----------	------------	------------------	------------------------

Cable Sets

RC-HE73 Stock-No. 8474				RC-HE75 Stock-No. 8516			
Farbe Colour				Farbe Colour			
blau blue		—		blau blue			
RC-HE76 Stock-No. 8655				RC-HE77 Stock-No. 8240			
Farbe Colour				Farbe Colour			
blau blue		—		blau blue			
RC-HE80 Stock-No. 8379				RC-HE81 Stock-No. 8518			
Farbe Colour				Farbe Colour			
blau blue		—		blau blue		—	

		SAE			M4			DIN			FORD COIL			5+7 mm insert
--	--	-----	--	--	----	--	--	-----	--	--	-----------	--	--	---------------

Cable Sets

cm

- 42 / 27
- 38 / 23
- 24 / 39
- 33 / 37
- 27 / 37
- 18 / 46
- 16 / 60

RC-JG1202
Stock-No. 5409

cm

- 25 / 30
- 29 / 30
- 29 / 33
- 31 / 37
- 35 / 41
- 22 / 45
- 16 / 16

RC-JG1203
Stock-No. 7703

Farbe Colour			
schwarz black			

Farbe Colour			
schwarz black			

cm

- 85
- 90
- 100
- 105
- 105
- 110
- 25

RC-JG1204
Stock-No. 2581

cm

- 62
- 62
- 68
- 77
- 84
- 100
- 36

RC-JG1205
Stock-No. 2475

Farbe Colour			
schwarz black			

Farbe Colour			
schwarz black			

cm

- 63
- 63
- 40
- 40
-
-
- 53

RC-KA401
Stock-No. 0714

cm

- 64
- 57
- 47
- 40
-
-
- 42

RC-KA402
Stock-No. 0715

Farbe Colour			
schwarz black			

Farbe Colour			
schwarz black			

--	--	--	--	--

Cable Sets

	<p>RC-KA1206 Stock-No. 6348</p>				<p>RC-LC201 Stock-No. 0663</p>		
Farbe Colour				Farbe Colour			
schwarz black		—		schwarz black		—	
	<p>RC-LC403 Stock-No. 0722</p>				<p>RC-LC406 Stock-No. 0725</p>		
Farbe Colour				Farbe Colour			
schwarz black				schwarz black			
	<p>RC-LC604 Stock-No. 8220</p>				<p>RC-LC606 Stock-No. 8222</p>		
Farbe Colour				Farbe Colour			
schwarz black				schwarz black			



SAE



M4



DIN

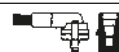

FORD COIL



5+7 mm insert

Cable Sets

RC-LC607
Stock-No. 8502

RC-LC609
Stock-No. 8524

Farbe Colour			
schwarz black			

Farbe Colour			
schwarz black			

RC-LC610
Stock-No. 8528

RC-LC611
Stock-No. 8529

Farbe Colour			
schwarz black			

Farbe Colour			
schwarz black			

RC-LC612
Stock-No. 8530

RC-LC614
Stock-No. 7206

Farbe Colour			
schwarz black		—	

Farbe Colour			
schwarz black			

SAE	M4	DIN	FORD COIL	5 + 7 mm insert
------------	-----------	------------	------------------	------------------------

Cable Sets

		<p>RC-LC615 Stock-No. 7207</p>			<p>RC-LC616 Stock-No. 7208</p>		
<p>Farbe Colour</p>				<p>Farbe Colour</p>			
<p>schwarz black</p>				<p>schwarz black</p>			
		<p>RC-LC617 Stock-No. 7286</p>			<p>RC-LC618 Stock-No. 7287</p>		
<p>Farbe Colour</p>				<p>Farbe Colour</p>			
<p>schwarz black</p>				<p>schwarz black</p>		<p>—</p>	
		<p>RC-LC901 Stock-No. 8575</p>			<p>RC-LC1101 Stock-No. 44231</p>		
<p>Farbe Colour</p>				<p>Farbe Colour</p>			
<p>schwarz black</p>		<p>—</p>		<p>schwarz black</p>		<p>—</p>	

		<p>SAE</p>		<p>M4</p>		<p>DIN</p>		<p>FORD COIL</p>		<p>5+7 mm insert</p>
--	--	------------	--	-----------	--	------------	--	------------------	--	----------------------

Cable Sets

RC-LC1102
Stock-No. 44242

RC-LC1201
Stock-No. 5408

Farbe Colour			
schwarz black			

Farbe Colour			
schwarz black			

RC-LC1202
Stock-No. 2588

RC-LC1203
Stock-No. 2589

Farbe Colour			
schwarz black			

Farbe Colour			
schwarz black			

RC-LC1205
Stock-No. 5590

RC-LC1206
Stock-No. 44275

Farbe Colour			
schwarz black			

Farbe Colour			
schwarz black			

SAE	M4	DIN	FORD COIL	5 + 7 mm insert
-----	----	-----	-----------	-----------------

Cable Sets

<p>RC-LC1301 Stock-No. 2997</p>				<p>RC-LC1302 Stock-No. 2999</p>			
<p>Farbe Colour</p>				<p>Farbe Colour</p>			
<p>schwarz black</p>		—		<p>schwarz black</p>		—	
<p>RC-LD301 Stock-No. 7068</p>				<p>RC-LD302 Stock-No. 7104</p>			
<p>Farbe Colour</p>				<p>Farbe Colour</p>			
<p>schwarz black</p>				<p>schwarz black</p>			
<p>RC-LD1201 Stock-No. 4943</p>				<p>RC-LD1202 Stock-No. 4944</p>			
<p>Farbe Colour</p>				<p>Farbe Colour</p>			
<p>schwarz black</p>		—		<p>schwarz black</p>		—	

SAE	M4	DIN	FORD COIL	5+7mm insert

Cable Sets

		<p>RC-LD1203 Stock-No. 4054</p>			<p>RC-LD1204 Stock-No. 9176</p>		
<p>Farbe Colour</p>				<p>Farbe Colour</p>			
<p>schwarz black</p>		<p>—</p>		<p>schwarz black</p>		<p>—</p>	
		<p>RC-LD1205 Stock-No. 6019</p>			<p>RC-MB201 Stock-No. 0736</p>		
<p>Farbe Colour</p>				<p>Farbe Colour</p>			
<p>schwarz black</p>		<p>—</p>		<p>schwarz black</p>		<p>—</p>	
		<p>RC-MB202 Stock-No. 0737</p>			<p>RC-MB203 Stock-No. 0738</p>		
<p>Farbe Colour</p>				<p>Farbe Colour</p>			
<p>schwarz black</p>		<p>—</p>		<p>schwarz black</p>		<p>—</p>	

		<p>SAE</p>		<p>M4</p>		<p>DIN</p>		<p>FORD COIL</p>		<p>5 + 7 mm insert</p>
--	--	------------	--	-----------	--	------------	--	------------------	--	------------------------

Cable Sets

<p>cm</p> <p>48</p> <p>58</p> <p>71</p> <p>74</p> <p>87</p> <p>97</p> <p>49</p> <p>RC-MB206 Stock-No. 0741</p>	<p>cm</p> <p>70</p> <p>85</p> <p>85</p> <p>100</p> <p>55</p> <p>RC-MB207 Stock-No. 0742</p>
<p>Farbe</p> <p>Colour</p>	<p>Farbe</p> <p>Colour</p>
<p>schwarz</p> <p>black</p>	<p>schwarz</p> <p>black</p>
<p>cm</p> <p>63</p> <p>63</p> <p>88</p> <p>88</p> <p>88</p> <p>99</p> <p>79</p> <p>RC-MB208 Stock-No. 0743</p>	<p>cm</p> <p>48</p> <p>58</p> <p>71</p> <p>74</p> <p>87</p> <p>97</p> <p>49</p> <p>RC-MB209 Stock-No. 0744</p>
<p>Farbe</p> <p>Colour</p>	<p>Farbe</p> <p>Colour</p>
<p>schwarz</p> <p>black</p>	<p>schwarz</p> <p>black</p>
<p>cm</p> <p>40</p> <p>48</p> <p>65</p> <p>65</p> <p>80</p> <p>93</p> <p>100</p> <p>RC-MB211 Stock-No. 0746</p>	<p>cm</p> <p>98 / 98</p> <p>90 / 90</p> <p>98</p> <p>98</p> <p>90</p> <p>90</p> <p>110 / 75</p> <p>RC-MB212 Stock-No. 0747</p>
<p>Farbe</p> <p>Colour</p>	<p>Farbe</p> <p>Colour</p>
<p>schwarz</p> <p>black</p>	<p>schwarz</p> <p>black</p>

<p>SAE</p>	<p>M4</p>	<p>DIN</p>	<p>FORD COIL</p>	<p>5+7mm insert</p>
------------	-----------	------------	------------------	---------------------

Cable Sets

cm

- 98 / 98
- 90 / 98
- 98
- 98
- 90
- 90
- 60 / 110

RC-MB213
Stock-No. 0748

cm

- 55
- 40
- 40
- 50
- 70
- 70
- 96

RC-MB214
Stock-No. 0749

Farbe Colour			
schwarz black			

Farbe Colour			
schwarz black			

cm

- 72 / 92
- 77 / 92
- 77
- 77
- 77
- 82
- 63

RC-MB215
Stock-No. 0750

cm

- 95 / 110
- 95 / 110
- 100
- 100
- 110
- 110
- 100

RC-MB216
Stock-No. 0751

Farbe Colour			
schwarz black			

Farbe Colour			
schwarz black			

cm

- 45
- 45
- 65
- 65
-
-
- 50

RC-MB217
Stock-No. 0752

cm

- 28
- 32
- 53
- 55
-
-
- 76

RC-MB218
Stock-No. 0753

Farbe Colour			
schwarz black			

Farbe Colour			
schwarz black			











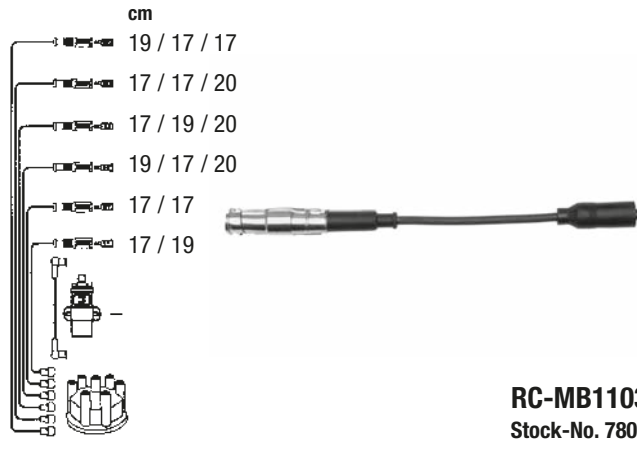
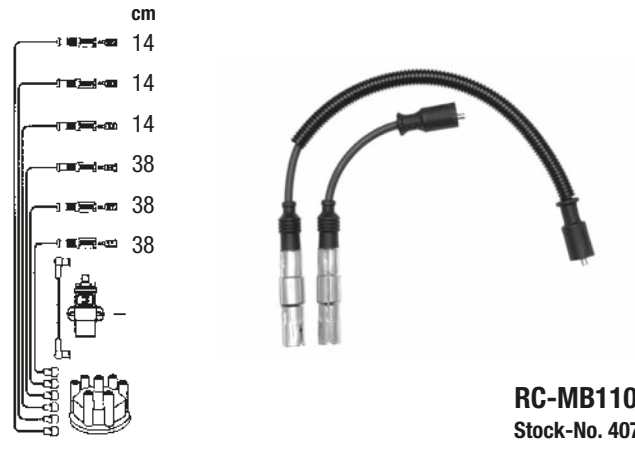









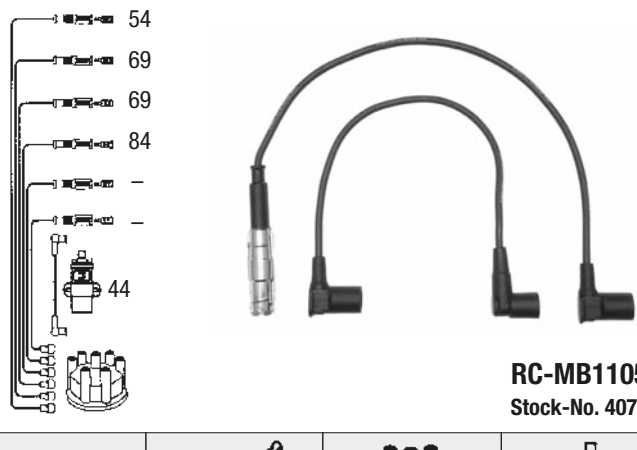











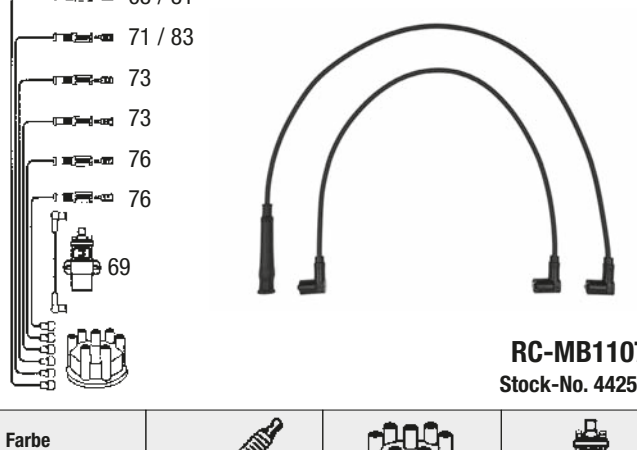
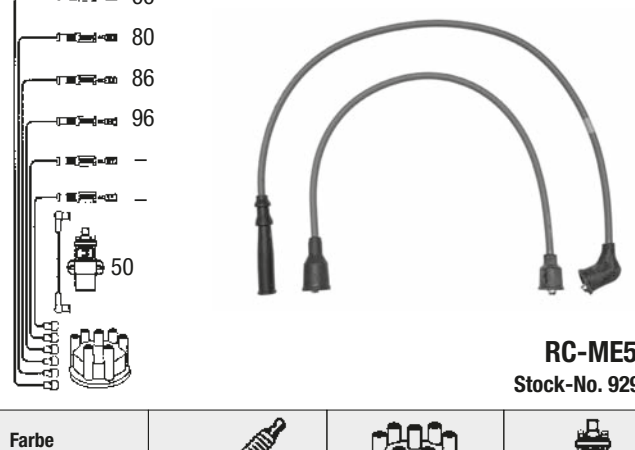

SAE	M4	DIN	FORD COIL	5 + 7 mm insert
------------	-----------	------------	------------------	------------------------

Cable Sets

<p>cm</p> <p>49</p> <p>49</p> <p>64</p> <p>64</p> <p>84</p> <p>84</p> <p>80</p>	<p>RC-MB219 Stock-No. 0754</p>			<p>cm</p> <p>49</p> <p>45</p> <p>40</p> <p>45</p> <p>-</p> <p>-</p>	<p>RC-MB220 Stock-No. 0755</p>		
<p>Farbe</p> <p>Colour</p>				<p>Farbe</p> <p>Colour</p>			
<p>schwarz</p> <p>black</p>				<p>schwarz</p> <p>black</p>		<p>—</p>	
<p>cm</p> <p>48</p> <p>48</p> <p>-</p> <p>-</p> <p>-</p> <p>-</p> <p>-</p> <p>-</p>	<p>RC-MB222 Stock-No. 0757</p>			<p>cm</p> <p>19 / 17</p> <p>17 / 17</p> <p>17 / 19</p> <p>19 / 17</p> <p>17 / 17</p> <p>17 / 19</p>	<p>RC-MB223 Stock-No. 0758</p>		
<p>Farbe</p> <p>Colour</p>				<p>Farbe</p> <p>Colour</p>			
<p>schwarz</p> <p>black</p>		<p>—</p>		<p>schwarz</p> <p>black</p>		<p>—</p>	
<p>cm</p> <p>103</p> <p>82</p> <p>101</p> <p>63</p> <p>88</p> <p>45</p> <p>-</p>	<p>RC-MB225 Stock-No. 7065</p>			<p>cm</p> <p>49</p> <p>59</p> <p>69</p> <p>87</p> <p>87</p> <p>99</p> <p>58</p>	<p>RC-MB1102 Stock-No. 2580</p>		
<p>Farbe</p> <p>Colour</p>				<p>Farbe</p> <p>Colour</p>			
<p>schwarz</p> <p>black</p>		<p>—</p>		<p>schwarz</p> <p>black</p>			

--	--	--	--	--

Cable Sets

<p>cm</p> <ul style="list-style-type: none"> 19 / 17 / 17 17 / 17 / 20 17 / 19 / 20 19 / 17 / 20 17 / 17 17 / 19  <p style="text-align: right;">RC-MB1103 Stock-No. 7800</p>				<p>cm</p> <ul style="list-style-type: none"> 14 14 38 38 38  <p style="text-align: right;">RC-MB1104 Stock-No. 4070</p>			
Farbe				Farbe			
Colour				Colour			
schwarz		—		schwarz		—	
black				black			
<p>cm</p> <ul style="list-style-type: none"> 54 69 69 84 — — 44  <p style="text-align: right;">RC-MB1105 Stock-No. 4071</p>				<p>cm</p> <ul style="list-style-type: none"> 27 32 33 34 — —  <p style="text-align: right;">RC-MB1106 Stock-No. 6349</p>			
Farbe				Farbe			
Colour				Colour			
schwarz				schwarz		—	
black				black			
<p>cm</p> <ul style="list-style-type: none"> 68 / 81 71 / 83 73 73 76 76 69  <p style="text-align: right;">RC-MB1107 Stock-No. 44251</p>				<p>cm</p> <ul style="list-style-type: none"> 66 80 86 96 — — 50  <p style="text-align: right;">RC-ME51 Stock-No. 9293</p>			
Farbe				Farbe			
Colour				Colour			
schwarz				blau			
black				blue			











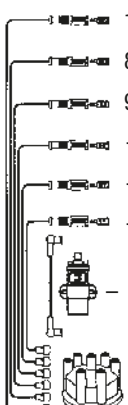

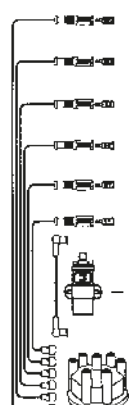











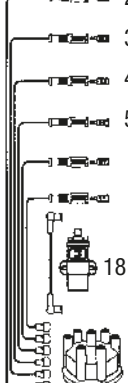

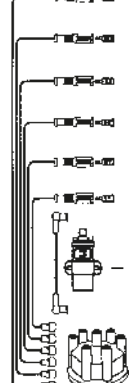











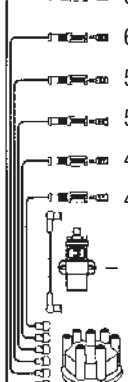
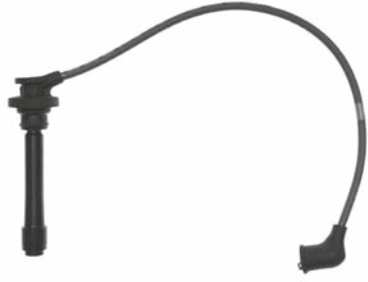
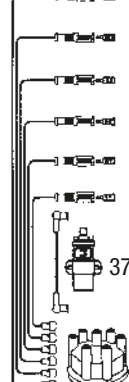

 SAE	 M4	 DIN	 FORD COIL	 5 + 7 mm insert
--	---	--	---	--

Cable Sets

	<p>RC-ME54 Stock-No. 9296</p>				<p>RC-ME59 Stock-No. 9302</p>		
Farbe <i>Colour</i>				Farbe <i>Colour</i>			
blau <i>blue</i>				blau <i>blue</i>			
	<p>RC-ME61 Stock-No. 8648</p>				<p>RC-ME63 Stock-No. 2560</p>		
Farbe <i>Colour</i>				Farbe <i>Colour</i>			
blau <i>blue</i>				blau <i>blue</i>			
	<p>RC-ME64 Stock-No. 8741</p>				<p>RC-ME71 Stock-No. 8570</p>		
Farbe <i>Colour</i>				Farbe <i>Colour</i>			
blau <i>blue</i>				blau <i>blue</i>			

		SAE		M4		DIN		FORD COIL		5+7 mm insert
--	--	------------	--	-----------	--	------------	--	------------------	--	----------------------

Cable Sets

<p>cm</p> <p>104</p> <p>80</p> <p>98</p> <p>—</p> <p>—</p> <p>—</p> <p>—</p> <p>—</p> <p>—</p> 	 <p>RC-ME95 Stock-No. 5074</p>			<p>cm</p> <p>44</p> <p>28</p> <p>—</p> <p>—</p> <p>—</p> <p>—</p> <p>—</p> <p>—</p> <p>—</p> 	 <p>RC-ME96 Stock-No. 4104</p>		
<p>Farbe</p> <p>Colour</p>				<p>Farbe</p> <p>Colour</p>			
<p>blau</p> <p>blue</p>		<p>—</p>		<p>blau</p> <p>blue</p>		<p>—</p>	
<p>cm</p> <p>24</p> <p>38</p> <p>41</p> <p>55</p> <p>—</p> <p>—</p> <p>—</p> <p>18</p> 	 <p>RC-ME106A Stock-No. 5762</p>			<p>cm</p> <p>35</p> <p>47</p> <p>57</p> <p>59</p> <p>—</p> <p>—</p> <p>—</p> 	 <p>RC-ME109 Stock-No. 2553</p>		
<p>Farbe</p> <p>Colour</p>				<p>Farbe</p> <p>Colour</p>			
<p>blau</p> <p>blue</p>				<p>blau</p> <p>blue</p>		<p>—</p>	
<p>cm</p> <p>62</p> <p>68</p> <p>50</p> <p>54</p> <p>46</p> <p>46</p> <p>—</p> 	 <p>RC-ME111 Stock-No. 2555</p>			<p>cm</p> <p>25</p> <p>37</p> <p>37</p> <p>48</p> <p>—</p> <p>—</p> <p>37</p> 	 <p>RC-MX401 Stock-No. 0759</p>		
<p>Farbe</p> <p>Colour</p>				<p>Farbe</p> <p>Colour</p>			
<p>blau</p> <p>blue</p>		<p>—</p>		<p>schwarz</p> <p>black</p>			



SAE



M4



DIN

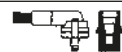

FORD COIL



5+7 mm insert

Cable Sets

cm
29
29
29
29
—
—
48

RC-MX1201
Stock-No. 7702

cm
69
55
53
41
—
—

RC-MX1202
Stock-No. 7700

Farbe Colour			
schwarz black			

Farbe Colour			
schwarz black		—	

cm
25
30
30
40
—
—
30

RC-MX1203
Stock-No. 4945

cm
16
16
22
30
—
—

RC-MX1204
Stock-No. 4946

Farbe Colour			
schwarz black			

Farbe Colour			
schwarz black		—	

cm
25
48
56
64
—
—
77

RC-MX1205
Stock-No. 4947

cm
32
33
37
45
—
—

RC-MX1206
Stock-No. 4052

Farbe Colour			
schwarz black			

Farbe Colour			
schwarz black		—	

SAE	M4	DIN	FORD COIL	5 + 7 mm insert
------------	-----------	------------	------------------	------------------------

								RC-MX1207 Stock-No. 4056			
Farbe <i>Colour</i>											
schwarz <i>black</i>											
								RC-MX1208 Stock-No. 4057			
Farbe <i>Colour</i>											
schwarz <i>black</i>											
								RC-MX1209 Stock-No. 9179			
Farbe <i>Colour</i>											
schwarz <i>black</i>											
								RC-MX1210 Stock-No. 4954			
Farbe <i>Colour</i>											
schwarz <i>black</i>								NO TERMINAL			
								RC-MX1211 Stock-No. 4978			
Farbe <i>Colour</i>											
schwarz <i>black</i>											
								RC-MX1212 Stock-No. 5589			
Farbe <i>Colour</i>											
schwarz <i>black</i>											

		SAE			M4			DIN			FORD COIL			5+7mm insert
--	--	------------	--	--	-----------	--	--	------------	--	--	------------------	--	--	---------------------

Cable Sets

<p>cm 37 47 47 57 27</p>	<p>RC-MX1213 Stock-No. 5782</p>			<p>cm 30 40</p>	<p>RC-MX1214 Stock-No. 5975</p>		
Farbe <i>Colour</i>				Farbe <i>Colour</i>			
schwarz <i>black</i>				schwarz <i>black</i>		—	NO TERMINAL
<p>cm 34 / 79 35 / 80 60 61 66 68 20</p>	<p>RC-MX1215 Stock-No. 6218</p>			<p>cm 66 58 44 34</p>	<p>RC-NE08 Stock-No. 9405</p>		
Farbe <i>Colour</i>				Farbe <i>Colour</i>			
schwarz <i>black</i>				blau <i>blue</i>		—	
<p>cm 60 54 38 34</p>	<p>RC-NE09 Stock-No. 9985</p>			<p>cm 40 47 66 68 85 93 52</p>	<p>RC-NE29 Stock-No. 5764</p>		
Farbe <i>Colour</i>				Farbe <i>Colour</i>			
blau <i>blue</i>		—		blau <i>blue</i>			

SAE	M4	DIN	FORD COIL	5 + 7 mm insert
------------	-----------	------------	------------------	------------------------

Cable Sets

<p>cm</p> <p>75</p> <p>75</p> <p>75</p> <p>83</p> <p>87</p> <p>88</p> <p>46</p>	<p>RC-NE61 Stock-No. 9409</p>			<p>cm</p> <p>70</p> <p>75</p> <p>73</p> <p>77</p> <p>—</p> <p>—</p> <p>37</p>	<p>RC-NE64 Stock-No. 8517</p>		
<p>Farbe</p> <p>Colour</p>				<p>Farbe</p> <p>Colour</p>			
<p>blau</p> <p>blue</p>				<p>blau</p> <p>blue</p>			
<p>cm</p> <p>35</p> <p>29</p> <p>25</p> <p>29</p> <p>—</p> <p>—</p> <p>45</p>	<p>RC-NE66 Stock-No. 9443</p>			<p>cm</p> <p>42</p> <p>13</p> <p>49</p> <p>25</p> <p>63</p> <p>35</p> <p>54</p>	<p>RC-NE77A Stock-No. 2679</p>		
<p>Farbe</p> <p>Colour</p>				<p>Farbe</p> <p>Colour</p>			
<p>blau</p> <p>blue</p>				<p>blau</p> <p>blue</p>			
<p>cm</p> <p>62</p> <p>56</p> <p>40</p> <p>30</p> <p>—</p> <p>—</p> <p>18</p>	<p>RC-NX07 Stock-No. 9459</p>			<p>cm</p> <p>60</p> <p>54</p> <p>42</p> <p>36</p> <p>—</p> <p>—</p>	<p>RC-NX11 Stock-No. 5075</p>		
<p>Farbe</p> <p>Colour</p>				<p>Farbe</p> <p>Colour</p>			
<p>blau</p> <p>blue</p>				<p>blau</p> <p>blue</p>		<p>—</p>	



SAE



M4



DIN

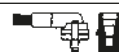

FORD COIL



5+7 mm insert

Cable Sets

<p>cm 44 42 58 54 58 74</p>	<p>RC-NX14 Stock-No. 2693</p>			<p>cm 64 66 86 88 48</p>	<p>RC-NX25 Stock-No. 3453</p>		
<p>Farbe Colour</p>				<p>Farbe Colour</p>			
<p>blau blue</p>		—		<p>blau blue</p>			
<p>cm 74 64 52 44 42</p>	<p>RC-NX71 Stock-No. 9464</p>			<p>cm 49 61 77 83 83 83 44</p>	<p>RC-NX81A Stock-No. 5076</p>		
<p>Farbe Colour</p>				<p>Farbe Colour</p>			
<p>blau blue</p>				<p>blau blue</p>			
<p>cm 68 / 50 64 / 70 90 88 34 54 44 / 51</p>	<p>RC-NX87 Stock-No. 9475</p>			<p>cm 67 49 45 31 38</p>	<p>RC-NX89 Stock-No. 9478</p>		
<p>Farbe Colour</p>				<p>Farbe Colour</p>			
<p>blau blue</p>				<p>blau blue</p>			

		SAE			DIN			FORD COIL		5 + 7 mm insert
--	--	-----	--	--	-----	--	--	-----------	--	-----------------

Cable Sets

<p>cm</p> <p>35</p> <p>67</p> <p>43</p> <p>71</p> <p>55</p> <p>69</p> <p>30</p>	<p>RC-NX91 Stock-No. 9480</p>			<p>cm</p> <p>36</p> <p>58</p> <p>50</p> <p>68</p> <p>72</p>	<p>RC-NX93 Stock-No. 9482</p>		
<p>Farbe</p> <p>Colour</p>				<p>Farbe</p> <p>Colour</p>			
<p>blau</p> <p>blue</p>				<p>blau</p> <p>blue</p>			
<p>cm</p> <p>55</p> <p>44</p> <p>39</p> <p>32</p> <p>—</p> <p>—</p> <p>—</p> <p>—</p>	<p>RC-OP201 Stock-No. 0766</p>			<p>cm</p> <p>50</p> <p>39</p> <p>27</p> <p>15</p> <p>—</p> <p>—</p> <p>26</p>	<p>RC-OP202 Stock-No. 0767</p>		
<p>Farbe</p> <p>Colour</p>				<p>Farbe</p> <p>Colour</p>			
<p>schwarz</p> <p>black</p>		<p>—</p>		<p>schwarz</p> <p>black</p>			
<p>cm</p> <p>63</p> <p>51</p> <p>39</p> <p>29</p> <p>—</p> <p>—</p> <p>48</p>	<p>RC-OP203 Stock-No. 0768</p>			<p>cm</p> <p>63</p> <p>51</p> <p>39</p> <p>29</p> <p>—</p> <p>—</p> <p>48</p>	<p>RC-OP204 Stock-No. 0769</p>		
<p>Farbe</p> <p>Colour</p>				<p>Farbe</p> <p>Colour</p>			
<p>schwarz</p> <p>black</p>				<p>schwarz</p> <p>black</p>			



SAE



M4



DIN

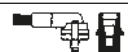

FORD COIL



5+7 mm insert

Cable Sets

cm
70
70
60
60
—
—
60

RC-OP301
Stock-No. 8265

cm
47
41
31
22
—
—
—

RC-OP304
Stock-No. 8458

Farbe Colour			
schwarz black			

Farbe Colour			
schwarz black		—	

cm
56
55
36
34
—
—
22

RC-OP306
Stock-No. 7070

cm
70
70
60
60
—
—
60

RC-OP307
Stock-No. 7080

Farbe Colour			
schwarz black			

Farbe Colour			
schwarz black			

cm
42
52
68
68
—
—
49

RC-OP402
Stock-No. 0772

cm
80
80
80
80
—
—
90

RC-OP403
Stock-No. 0773

Farbe Colour			
schwarz black			

Farbe Colour			
schwarz black			

SAE	M4	DIN	FORD COIL	5 + 7 mm insert
-----	----	-----	-----------	-----------------

Cable Sets

<p>cm</p> <p>37</p> <p>42</p> <p>54</p> <p>59</p> <p>—</p> <p>—</p> <p>37</p>	<p>RC-OP408 Stock-No. 0778</p>			<p>cm</p> <p>38</p> <p>65</p> <p>87</p> <p>87</p> <p>—</p> <p>—</p> <p>100</p>	<p>RC-OP411 Stock-No. 0781</p>		
<p>Farbe</p> <p>Colour</p>				<p>Farbe</p> <p>Colour</p>			
<p>schwarz</p> <p>black</p>				<p>schwarz</p> <p>black</p>			
<p>cm</p> <p>38</p> <p>58</p> <p>76</p> <p>78</p> <p>—</p> <p>—</p> <p>110</p>	<p>RC-OP412 Stock-No. 0782</p>			<p>cm</p> <p>24</p> <p>34</p> <p>48</p> <p>55</p> <p>66</p> <p>77</p> <p>35</p>	<p>RC-OP413 Stock-No. 0783</p>		
<p>Farbe</p> <p>Colour</p>				<p>Farbe</p> <p>Colour</p>			
<p>schwarz</p> <p>black</p>				<p>schwarz</p> <p>black</p>			
<p>cm</p> <p>61</p> <p>86</p> <p>91</p> <p>29</p> <p>46</p> <p>62</p> <p>49</p>	<p>RC-OP414 Stock-No. 0784</p>			<p>cm</p> <p>36</p> <p>56</p> <p>69</p> <p>74</p> <p>—</p> <p>—</p> <p>44</p>	<p>RC-OP418 Stock-No. 0788</p>		
<p>Farbe</p> <p>Colour</p>				<p>Farbe</p> <p>Colour</p>			
<p>schwarz</p> <p>black</p>				<p>schwarz</p> <p>black</p>			



SAE



M4



DIN

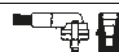

FORD COIL



5+7 mm insert

Cable Sets

cm
48
60
73
78
—
—
48

RC-OP419
Stock-No. 0789

cm
32
46
62
69
—
—
46

RC-OP421
Stock-No. 0791

Farbe Colour			
schwarz black			

Farbe Colour			
schwarz black			

cm
47
60
74
78
—
—
30

RC-OP423
Stock-No. 0793

cm
33
62
87
87
—
—
62

RC-OP426
Stock-No. 0796

Farbe Colour			
schwarz black			

Farbe Colour			
schwarz black			

cm
48
65
75
83
—
—
48

RC-OP427
Stock-No. 0797

cm
60
38
60
38
—
—
100

RC-OP430
Stock-No. 0800

Farbe Colour			
schwarz black			

Farbe Colour			
schwarz black			

SAE	M4	DIN	FORD COIL	5 + 7 mm insert
-----	----	-----	-----------	-----------------

Cable Sets

	<p>RC-OP432 Stock-No. 0802</p>				<p>RC-OP434 Stock-No. 0804</p>		
Farbe Colour				Farbe Colour			
schwarz black				schwarz black			
	<p>RC-OP436 Stock-No. 0806</p>				<p>RC-OP438 Stock-No. 0808</p>		
Farbe Colour				Farbe Colour			
schwarz black				schwarz black			
	<p>RC-OP440 Stock-No. 0810</p>				<p>RC-OP442 Stock-No. 0812</p>		
Farbe Colour				Farbe Colour			
schwarz black				schwarz black			



SAE



M4



DIN

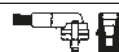

FORD COIL



5+7 mm insert

Cable Sets

RC-OP444
Stock-No. 0814

RC-OP447
Stock-No. 0817

Farbe Colour			
schwarz black			

Farbe Colour			
schwarz black			

RC-OP448
Stock-No. 0818

RC-OP450
Stock-No. 0820

Farbe Colour			
schwarz black			

Farbe Colour			
schwarz black		—	

RC-OP453
Stock-No. 0823

RC-OP455
Stock-No. 0825

Farbe Colour			
schwarz black			

Farbe Colour			
schwarz black			

SAE	M4	DIN	FORD COIL	5 + 7 mm insert
------------	-----------	------------	------------------	------------------------

Cable Sets

<p>cm</p> <p>80</p> <p>70</p> <p>60</p> <p>50</p> <p>—</p> <p>—</p> <p>37</p>	<p>RC-OP458 Stock-No. 0828</p>			<p>cm</p> <p>26</p> <p>37</p> <p>52</p> <p>57</p> <p>69</p> <p>82</p> <p>42</p>	<p>RC-OP459 Stock-No. 0829</p>		
<p>Farbe</p> <p>Colour</p>				<p>Farbe</p> <p>Colour</p>			
<p>schwarz</p> <p>black</p>				<p>schwarz</p> <p>black</p>			
<p>cm</p> <p>53</p> <p>46</p> <p>38</p> <p>22</p> <p>—</p> <p>—</p> <p>—</p>	<p>RC-OP463 Stock-No. 0833</p>			<p>cm</p> <p>85</p> <p>76</p> <p>73</p> <p>64</p> <p>—</p> <p>—</p> <p>—</p>	<p>RC-OP465 Stock-No. 0835</p>		
<p>Farbe</p> <p>Colour</p>				<p>Farbe</p> <p>Colour</p>			
<p>schwarz</p> <p>black</p>		<p>—</p>		<p>schwarz</p> <p>black</p>		<p>—</p>	
<p>cm</p> <p>38</p> <p>54</p> <p>59</p> <p>71</p> <p>76</p> <p>92</p> <p>39</p>	<p>RC-OP466 Stock-No. 0836</p>			<p>cm</p> <p>53</p> <p>53</p> <p>53</p> <p>28</p> <p>—</p> <p>—</p> <p>—</p>	<p>RC-OP1101 Stock-No. 6307</p>		
<p>Farbe</p> <p>Colour</p>				<p>Farbe</p> <p>Colour</p>			
<p>schwarz</p> <p>black</p>				<p>schwarz</p> <p>black</p>		<p>—</p>	

		<p>SAE</p>		<p>M4</p>		<p>DIN</p>		<p>FORD COIL</p>		<p>5+7 mm insert</p>
--	--	------------	--	-----------	--	------------	--	------------------	--	----------------------

Cable Sets

cm
60
65
70
70
70
75

RC-OP1201
Stock-No. 2582

cm
47
47
60
60
66

RC-OP1202
Stock-No. 2590

Farbe Colour			
schwarz black		—	

Farbe Colour			
schwarz black			

cm
55
55
43
29
—
—

RC-OP1203
Stock-No. 6995

cm
62
56
40
33
—
—
40

RC-OP1204
Stock-No. 6990

Farbe Colour			
schwarz black		—	

Farbe Colour			
schwarz black			

cm
95
39
68
26
57
17

RC-OP1205
Stock-No. 4059

cm
80
55
62
39
56
30

RC-OP1206
Stock-No. 4061

Farbe Colour			
schwarz black		—	

Farbe Colour			
schwarz black		—	

SAE	M4	DIN	FORD COIL	5 + 7 mm insert
-----	----	-----	-----------	-----------------

Cable Sets

<p>cm</p> <p>28</p> <p>46</p> <p>48</p> <p>53</p> <p>—</p> <p>—</p> <p>—</p> <p>—</p>	<p>RC-OP1208 Stock-No. 4069</p>			<p>cm</p> <p>65</p> <p>59</p> <p>44</p> <p>37</p> <p>—</p> <p>—</p> <p>—</p> <p>47</p>	<p>RC-OP1209 Stock-No. 6257</p>		
<p>Farbe</p> <p>Colour</p>				<p>Farbe</p> <p>Colour</p>			
<p>schwarz</p> <p>black</p>		<p>—</p>		<p>schwarz</p> <p>black</p>			
<p>cm</p> <p>60</p> <p>65</p> <p>75</p> <p>80</p> <p>—</p> <p>—</p> <p>—</p> <p>60</p>	<p>RC-OP1210 Stock-No. 1401</p>			<p>cm</p> <p>45</p> <p>55</p> <p>70</p> <p>75</p> <p>—</p> <p>—</p> <p>—</p>	<p>RC-OP1211 Stock-No. 8822</p>		
<p>Farbe</p> <p>Colour</p>				<p>Farbe</p> <p>Colour</p>			
<p>schwarz</p> <p>black</p>				<p>schwarz</p> <p>black</p>		<p>—</p>	
<p>cm</p> <p>29</p> <p>37</p> <p>52</p> <p>57</p> <p>69</p> <p>80</p> <p>—</p> <p>42</p>	<p>RC-OP1212 Stock-No. 1590</p>			<p>cm</p> <p>32</p> <p>32</p> <p>55</p> <p>55</p> <p>—</p> <p>—</p> <p>—</p> <p>23</p>	<p>RC-OP1213 Stock-No. 8745</p>		
<p>Farbe</p> <p>Colour</p>				<p>Farbe</p> <p>Colour</p>			
<p>schwarz</p> <p>black</p>				<p>schwarz</p> <p>black</p>			

	<p>SAE</p>		<p>M4</p>		<p>DIN</p>		<p>FORD COIL</p>		<p>5+7 mm insert</p>
--	------------	--	-----------	--	------------	--	------------------	--	----------------------

Cable Sets

cm
49
63
75
75
—
—
30

RC-OP1214
Stock-No. 1683

cm
60
61
75
75
—
—

RC-OP1215
Stock-No. 1410

Farbe Colour			
schwarz black			

Farbe Colour			
schwarz black		—	

cm
65
73
75
85
—
—

RC-OP1216
Stock-No. 1399

cm
37
51
62
70
—
—
36

RC-OP1217
Stock-No. 1689

Farbe Colour			
schwarz black		—	

Farbe Colour			
schwarz black			

cm
38
44
63
66
—
—
26

RC-OP1218
Stock-No. 8707

cm
35
56
35
56
—
—
50

RC-OP1219
Stock-No. 1585

Farbe Colour			
schwarz black			

Farbe Colour			
schwarz black			

SAE	M4	DIN	FORD COIL	5 + 7 mm insert
-----	----	-----	-----------	-----------------

Cable Sets

<p>cm 30 40 50 60 25</p>	<p>RC-PG406 Stock-No. 0842</p>			<p>cm 56 68 78 82 92</p>	<p>RC-PG601 Stock-No. 8182</p>		
<p>Farbe Colour</p>				<p>Farbe Colour</p>			
<p>schwarz black</p>				<p>schwarz black</p>			
<p>cm 30 39 48 58 26</p>	<p>RC-PG602 Stock-No. 8467</p>			<p>cm 51 63 73 86 85</p>	<p>RC-PG603 Stock-No. 8495</p>		
<p>Farbe Colour</p>				<p>Farbe Colour</p>			
<p>schwarz black</p>				<p>schwarz black</p>			
<p>cm 54 61 69 74 55</p>	<p>RC-PG604 Stock-No. 7374</p>			<p>cm 55 55 55 60 74</p>	<p>RC-PG605 Stock-No. 7376</p>		
<p>Farbe Colour</p>				<p>Farbe Colour</p>			
<p>schwarz black</p>				<p>schwarz black</p>			

		SAE			M4			DIN			FORD COIL			5+7 mm insert
--	--	------------	--	--	-----------	--	--	------------	--	--	------------------	--	--	----------------------

Cable Sets

cm
57
69
79
92
56

RC-PG607
Stock-No. 7399

cm
40
49
62
75
59

RC-PG608
Stock-No. 7109

Farbe Colour			
schwarz black			

Farbe Colour			
schwarz black			

cm
40
55
60
85
95
100
40

RC-PG609
Stock-No. 7111

cm
45
55
65
75
65

RC-PG611
Stock-No. 7319

Farbe Colour			
schwarz black			

Farbe Colour			
schwarz black			

cm
40
40
50
60
76

RC-PG612
Stock-No. 7157

cm
51
63
73
86
57

RC-PG615
Stock-No. 7176

Farbe Colour			
schwarz black			

Farbe Colour			
schwarz black			

SAE	M4	DIN	FORD COIL	5 + 7 mm insert
------------	-----------	------------	------------------	------------------------

Cable Sets

		<p>RC-PG616 Stock-No. 7216</p>			<p>RC-PG617 Stock-No. 7275</p>		
<p>Farbe Colour</p>				<p>Farbe Colour</p>			
<p>schwarz black</p>				<p>schwarz black</p>		<p>—</p>	
		<p>RC-PG618 Stock-No. 7294</p>			<p>RC-PG1301 Stock-No. 2578</p>		
<p>Farbe Colour</p>				<p>Farbe Colour</p>			
<p>schwarz black</p>				<p>schwarz black</p>			
		<p>RC-PG1302 Stock-No. 6071</p>			<p>RC-PS1101 Stock-No. 2583</p>		
<p>Farbe Colour</p>				<p>Farbe Colour</p>			
<p>schwarz black</p>				<p>schwarz black</p>			

		<p>SAE</p>			<p>M4</p>			<p>DIN</p>			<p>FORD COIL</p>			<p>5+7 mm insert</p>
--	--	------------	--	--	-----------	--	--	------------	--	--	------------------	--	--	----------------------

Cable Sets

<p>RC-PS1102 Stock-No. 6309</p>				<p>RC-PS1103 Stock-No. 6316</p>			
Farbe Colour				Farbe Colour			
schwarz black				schwarz black			
<p>RC-PS1106 Stock-No. 44276</p>				<p>RC-RN409 Stock-No. 0860</p>			
Farbe Colour				Farbe Colour			
schwarz black				schwarz black			
<p>RC-RN601 Stock-No. 8183</p>				<p>RC-RN602 Stock-No. 8184</p>			
Farbe Colour				Farbe Colour			
schwarz black				schwarz black			

SAE	M4	DIN	FORD COIL	5 + 7 mm insert
-----	----	-----	-----------	-----------------

Cable Sets

<p>RC-RN603 Stock-No. 8185</p>				<p>RC-RN606 Stock-No. 8234</p>			
Farbe Colour				Farbe Colour			
schwarz black		—		schwarz black		—	
<p>RC-RN608 Stock-No. 8492</p>				<p>RC-RN611 Stock-No. 8253</p>			
Farbe Colour				Farbe Colour			
schwarz black		—		schwarz black			
<p>RC-RN619 Stock-No. 8470</p>				<p>RC-RN620 Stock-No. 8487</p>			
Farbe Colour				Farbe Colour			
schwarz black				schwarz black			

SAE	M4	DIN	FORD COIL	5+7 mm insert

Cable Sets

<p>cm 24 36 39 53 89</p>	<p>RC-RN623 Stock-No. 8493</p>			<p>cm 33 49 53 65 63</p>	<p>RC-RN627 Stock-No. 8505</p>		
<p>Farbe Colour</p>				<p>Farbe Colour</p>			
<p>schwarz black</p>				<p>schwarz black</p>			
<p>cm 30 42 50 60 50</p>	<p>RC-RN629 Stock-No. 8507</p>			<p>cm 41 41 61 65 70</p>	<p>RC-RN632 Stock-No. 8510</p>		
<p>Farbe Colour</p>				<p>Farbe Colour</p>			
<p>schwarz black</p>				<p>schwarz black</p>			
<p>cm 40 44 66 67 42</p>	<p>RC-RN637 Stock-No. 7368</p>			<p>cm 30 30 35 35 55</p>	<p>RC-RN639 Stock-No. 7375</p>		
<p>Farbe Colour</p>				<p>Farbe Colour</p>			
<p>schwarz black</p>				<p>schwarz black</p>			

SAE	M4	DIN	FORD COIL	5 + 7 mm insert
-----	----	-----	-----------	-----------------

Cable Sets

<p>cm</p> <p>33</p> <p>33</p> <p>33</p> <p>33</p> <p>70</p>	<p>RC-RN640 Stock-No. 7379</p>			<p>cm</p> <p>41</p> <p>51</p> <p>66</p> <p>69</p> <p>26</p>	<p>RC-RN645 Stock-No. 7108</p>		
<p>Farbe</p> <p>Colour</p>				<p>Farbe</p> <p>Colour</p>			
<p>schwarz</p> <p>black</p>				<p>schwarz</p> <p>black</p>			
<p>cm</p> <p>40</p> <p>40</p> <p>60</p> <p>65</p> <p>70</p>	<p>RC-RN646 Stock-No. 7151</p>			<p>cm</p> <p>30</p> <p>30</p> <p>30</p> <p>30</p> <p>105</p>	<p>RC-RN648 Stock-No. 7153</p>		
<p>Farbe</p> <p>Colour</p>				<p>Farbe</p> <p>Colour</p>			
<p>schwarz</p> <p>black</p>				<p>schwarz</p> <p>black</p>			
<p>cm</p> <p>51</p> <p>66</p> <p>76</p> <p>84</p> <p>89</p> <p>91</p> <p>70</p>	<p>RC-RN649 Stock-No. 7154</p>			<p>cm</p> <p>40</p> <p>45</p> <p>50</p> <p>50</p> <p>60</p> <p>65</p> <p>60</p>	<p>RC-RN650 Stock-No. 7167</p>		
<p>Farbe</p> <p>Colour</p>				<p>Farbe</p> <p>Colour</p>			
<p>schwarz</p> <p>black</p>				<p>schwarz</p> <p>black</p>			



SAE



M4



DIN

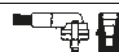

FORD COIL



5+7mm insert

Cable Sets

cm
65
68
68
75
—
—
52

RC-RN651
Stock-No. 7170

cm
40
55
65
70
—
—

RC-RN652
Stock-No. 7175

Farbe Colour			
schwarz black			

Farbe Colour			
schwarz black		—	

cm
65
50
35
97
85
70
68

RC-RN653
Stock-No. 7183

cm
33
49
52
66
—
—
39

RC-RN655
Stock-No. 7190

Farbe Colour			
schwarz black			

Farbe Colour			
schwarz black			

cm
49
33
28
27
—
—

RC-RN657
Stock-No. 7198

cm
56
32
26
22
—
—

RC-RN658
Stock-No. 7200

Farbe Colour			
schwarz black		—	

Farbe Colour			
schwarz black		—	

SAE	M4	DIN	FORD COIL	5 + 7 mm insert
------------	-----------	------------	------------------	------------------------

Cable Sets

<p>cm 30 30 30 30 33</p> <p>RC-RN1201 Stock-No. 6981</p>	<p>cm 51 37 27 31</p> <p>RC-RN1202 Stock-No. 4053</p>
<p>Farbe Colour</p>	<p>Farbe Colour</p>
<p>schwarz black</p>	<p>schwarz black</p>
<p>cm 49 33 28 27</p> <p>RC-RN1203 Stock-No. 4081</p>	<p>cm 35 39 42 55</p> <p>RC-RN1204 Stock-No. 6794</p>
<p>Farbe Colour</p>	<p>Farbe Colour</p>
<p>schwarz black</p>	<p>schwarz black</p>
<p>cm 35 52 65 67 82 105</p> <p>RC-RN1301 Stock-No. 2586</p>	<p>cm 35 35 35 35 45</p> <p>RC-RN1302 Stock-No. 2587</p>
<p>Farbe Colour</p>	<p>Farbe Colour</p>
<p>schwarz black</p>	<p>schwarz black</p>

<p>SAE</p>	<p>M4</p>	<p>DIN</p>	<p>FORD COIL</p>	<p>5+7mm insert</p>
------------	-----------	------------	------------------	---------------------

Cable Sets

cm
28
37
42
55
—
—
88

RC-RN1304
Stock-No. 5595

cm
30
30
30
—
—
50

RC-RN1305
Stock-No. 6024

Farbe Colour			
schwarz black			

Farbe Colour			
schwarz black			

cm
34
41
53
62
—
—
56

RC-RN1306
Stock-No. 6045

cm
37
45
55
65
—
—
40

RC-RN1307
Stock-No. 6070

Farbe Colour			
schwarz black			

Farbe Colour			
schwarz black			

cm
41
47
55
70
—
—
—

RC-RN1308
Stock-No. 44225

cm
45
60
65
65
—
—
30

RC-RN1309
Stock-No. 44232

Farbe Colour			
schwarz black		—	

Farbe Colour			
schwarz black			

SAE	M4	DIN	FORD COIL	5 + 7 mm insert
------------	-----------	------------	------------------	------------------------

Cable Sets

<p>RC-RN1310 Stock-No. 44248</p>				<p>RC-RN1311 Stock-No. 44278</p>			
Farbe Colour				Farbe Colour			
schwarz black		—		schwarz black		—	
<p>RC-RV301 Stock-No. 8266</p>				<p>RC-RV302 Stock-No. 8267</p>			
Farbe Colour				Farbe Colour			
schwarz black		—		schwarz black			
<p>RC-RV303 Stock-No. 8268</p>				<p>RC-RV304 Stock-No. 8269</p>			
Farbe Colour				Farbe Colour			
schwarz black				schwarz black			

SAE	M4	DIN	FORD COIL	5+7 mm insert

Cable Sets

RC-RV305 Stock-No. 8270				RC-RV307 Stock-No. 8272			
Farbe Colour				Farbe Colour			
schwarz black		—		schwarz black			
RC-RV308 Stock-No. 8274				RC-RV309 Stock-No. 8279			
Farbe Colour				Farbe Colour			
schwarz black		—		schwarz black			
RC-RV313 Stock-No. 8297				RC-RV315 Stock-No. 8299			
Farbe Colour				Farbe Colour			
schwarz black				schwarz black		—	

SAE	M4	DIN	FORD COIL	5 + 7 mm insert
-----	----	-----	-----------	-----------------

Cable Sets

<p>cm 58 47 46 34 43</p>				<p>RC-RV316 Stock-No. 8461</p>				<p>cm 59 48 49 34 43</p>				<p>RC-RV318 Stock-No. 7366</p>			
Farbe Colour				Farbe Colour				Farbe Colour							
schwarz black				schwarz black				schwarz black							
<p>cm 66 / 51 60 / 37 56 41 59 57</p>				<p>RC-RV322 Stock-No. 7078</p>				<p>cm 60 / 53 71 / 51 54 71 65 78</p>				<p>RC-RV323 Stock-No. 7079</p>			
Farbe Colour				Farbe Colour				Farbe Colour							
schwarz black		—		schwarz black		—		schwarz black							
<p>cm 58 50 38 29 36</p>				<p>RC-RV401 Stock-No. 0876</p>				<p>cm 72 69 54 40 32</p>				<p>RC-RV404 Stock-No. 0879</p>			
Farbe Colour				Farbe Colour				Farbe Colour							
schwarz black				schwarz black				schwarz black							



SAE



M4



DIN

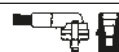

FORD COIL



5+7mm insert

Cable Sets

cm
22
22
22
25
—
—
37

RC-RV406
Stock-No. 0881

cm
30
23
23
30
—
—
—

RC-RV410
Stock-No. 0885

Farbe Colour			
schwarz black			

Farbe Colour			
schwarz black		—	

cm
52
54
34
36
—
—
78

RC-RV412
Stock-No. 0887

cm
37
41
51
58
—
—
78

RC-RV413
Stock-No. 0888

Farbe Colour			
schwarz black			

Farbe Colour			
schwarz black			

cm
52
54
34
35
—
—
40

RC-RV414
Stock-No. 0889

cm
56
49
38
36
—
—
40

RC-RV415
Stock-No. 0890

Farbe Colour			
schwarz black			

Farbe Colour			
schwarz black			











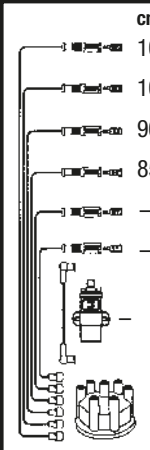

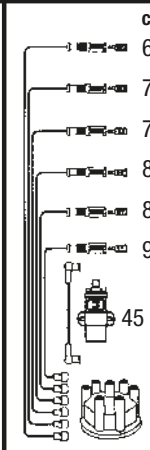











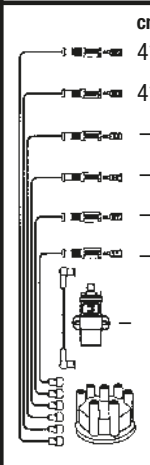

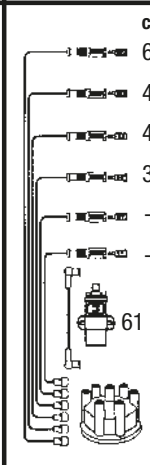











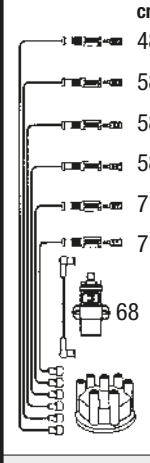

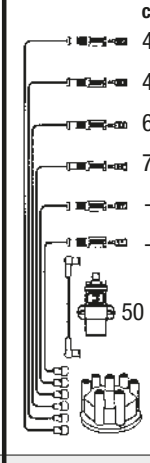



SAE	M4	DIN	FORD COIL	5 + 7 mm insert
-----	----	-----	-----------	-----------------

Cable Sets

RC-RV603 Stock-No. 8496				RC-RV604 Stock-No. 8499			
Farbe Colour				Farbe Colour			
schwarz black		—		schwarz black		—	
RC-RV605 Stock-No. 7384				RC-RV901 Stock-No. 7408			
Farbe Colour				Farbe Colour			
schwarz black				schwarz black		—	
RC-RV1201 Stock-No. 2585				RC-RV1202 Stock-No. 7705			
Farbe Colour				Farbe Colour			
schwarz black				schwarz black		—	

		SAE			M4			DIN			FORD COIL			5+7mm insert
--	--	-----	--	--	----	--	--	-----	--	--	-----------	--	--	--------------

Cable Sets

<p>cm</p> <ul style="list-style-type: none"> 108 104 96 85 - - - 	 <p>RC-RV1203 Stock-No. 7707</p>	<p>cm</p> <ul style="list-style-type: none"> 65 75 75 80 89 92 45 	 <p>RC-RV1204 Stock-No. 5401</p>				
<p>Farbe Colour</p>				<p>Farbe Colour</p>			
<p>schwarz black</p>		<p>—</p>		<p>schwarz black</p>			
<p>cm</p> <ul style="list-style-type: none"> 41 41 - - - - - 	 <p>RC-RV1205 Stock-No. 7706</p>	<p>cm</p> <ul style="list-style-type: none"> 61 49 48 33 - - 61 	 <p>RC-RV1206 Stock-No. 7708</p>				
<p>Farbe Colour</p>				<p>Farbe Colour</p>			
<p>schwarz black</p>		<p>—</p>		<p>schwarz black</p>			
<p>cm</p> <ul style="list-style-type: none"> 48 / 71 58 / 91 58 58 71 71 68 	 <p>RC-RV1207 Stock-No. 2577</p>	<p>cm</p> <ul style="list-style-type: none"> 45 45 65 70 - - 50 	 <p>RC-RV1208 Stock-No. 44241</p>				
<p>Farbe Colour</p>				<p>Farbe Colour</p>			
<p>schwarz black</p>				<p>schwarz black</p>			

  <p>SAE</p>	  <p>M4</p>	 <p>DIN</p>	 <p>FORD COIL</p>	 <p>5 + 7 mm insert</p>
--	---	--	---	--

Cable Sets

<p>cm</p> <p>35</p> <p>50</p> <p>50</p> <p>60</p> <p>70</p>	<p>RC-RV1209 Stock-No. 44247</p>			<p>cm</p> <p>23</p> <p>19</p> <p>29</p> <p>31</p>	<p>RC-RV1301 Stock-No. 2476</p>		
<p>Farbe</p> <p>Colour</p>				<p>Farbe</p> <p>Colour</p>			
<p>schwarz</p> <p>black</p>				<p>schwarz</p> <p>black</p>		<p>—</p>	
<p>cm</p> <p>73</p> <p>64</p> <p>64</p> <p>42</p>	<p>RC-RV1302 Stock-No. 5400</p>			<p>cm</p> <p>60</p> <p>60</p> <p>80</p> <p>80</p> <p>40</p>	<p>RC-SB406 Stock-No. 0896</p>		
<p>Farbe</p> <p>Colour</p>				<p>Farbe</p> <p>Colour</p>			
<p>schwarz</p> <p>black</p>		<p>—</p>		<p>schwarz</p> <p>black</p>			
<p>cm</p> <p>83</p> <p>65</p> <p>73</p> <p>43</p> <p>55</p> <p>43</p>	<p>RC-SB408 Stock-No. 0898</p>			<p>cm</p> <p>38</p> <p>42</p> <p>62</p> <p>67</p> <p>22</p>	<p>RC-SB601 Stock-No. 8187</p>		
<p>Farbe</p> <p>Colour</p>				<p>Farbe</p> <p>Colour</p>			
<p>schwarz</p> <p>black</p>		<p>—</p>		<p>schwarz</p> <p>black</p>			



SAE



M4



DIN

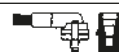

FORD COIL



5+7 mm insert

Cable Sets

	<p>RC-SB604 Stock-No. 8190</p>				<p>RC-SB605 Stock-No. 8200</p>		
Farbe Colour				Farbe Colour			
schwarz black				schwarz black			
	<p>RC-SB1301 Stock-No. 44246</p>				<p>RC-SD401 Stock-No. 0899</p>		
Farbe Colour				Farbe Colour			
schwarz black				schwarz black			
	<p>RC-SD402 Stock-No. 0900</p>				<p>RC-SD1201 Stock-No. 5404</p>		
Farbe Colour				Farbe Colour			
schwarz black				schwarz black			

SAE	M4	DIN	FORD COIL	5 + 7 mm insert
-----	----	-----	-----------	-----------------

Cable Sets

	<p>RC-SD1202 Stock-No. 44254</p>				<p>RC-SE02 Stock-No. 8312</p>		
Farbe Colour				Farbe Colour			
schwarz black				blau blue			
	<p>RC-SE13 Stock-No. 3067</p>				<p>RC-SE14 Stock-No. 5293</p>		
Farbe Colour				Farbe Colour			
blau blue				blau blue			
	<p>RC-SE17 Stock-No. 2706</p>				<p>RC-SE77 Stock-No. 8047</p>		
Farbe Colour				Farbe Colour			
blau blue				blau blue			

--	--	--	--	--	--

Cable Sets

<p>RC-SE82 Stock-No. 2717</p>				<p>RC-SE83 Stock-No. 8748</p>			
Farbe Colour				Farbe Colour			
blau blue				blau blue			
<p>RC-SE93 Stock-No. 8073</p>				<p>RC-SE94 Stock-No. 8059</p>			
Farbe Colour				Farbe Colour			
blau blue				blau blue			
<p>RC-SE95 Stock-No. 8068</p>				<p>RC-ST201 Stock-No. 0901</p>			
Farbe Colour				Farbe Colour			
blau blue				schwarz black			

SAE	M4	DIN	FORD COIL	5 + 7 mm insert
------------	-----------	------------	------------------	------------------------

Cable Sets

		<p>RC-ST204 Stock-No. 7061</p>			<p>RC-ST403 Stock-No. 0904</p>		
<p>Farbe Colour</p>				<p>Farbe Colour</p>			
<p>schwarz black</p>		<p>—</p>		<p>schwarz black</p>			
		<p>RC-ST404 Stock-No. 0905</p>			<p>RC-ST405 Stock-No. 0906</p>		
<p>Farbe Colour</p>				<p>Farbe Colour</p>			
<p>schwarz black</p>				<p>schwarz black</p>			
		<p>RC-ST406 Stock-No. 0907</p>			<p>RC-ST601 Stock-No. 7196</p>		
<p>Farbe Colour</p>				<p>Farbe Colour</p>			
<p>schwarz black</p>				<p>schwarz black</p>			

SAE	M4	DIN	FORD COIL	5+7 mm insert

Cable Sets

	<p>RC-TE25 Stock-No. 5347</p>				<p>RC-TE26 Stock-No. 5348</p>		
Farbe <i>Colour</i>				Farbe <i>Colour</i>			
blau <i>blue</i>				blau <i>blue</i>			
	<p>RC-TE28 Stock-No. 5349</p>				<p>RC-TE41 Stock-No. 9616</p>		
Farbe <i>Colour</i>				Farbe <i>Colour</i>			
blau <i>blue</i>				blau <i>blue</i>		—	
	<p>RC-TE42 Stock-No. 9617</p>				<p>RC-TE43 Stock-No. 9618</p>		
Farbe <i>Colour</i>				Farbe <i>Colour</i>			
blau <i>blue</i>				blau <i>blue</i>		—	



SAE



M4



DIN

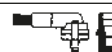

FORD COIL



5+7 mm insert

Cable Sets

cm
62
48
46
30
—
—
45

RC-TE44
Stock-No. 5351

cm
62
48
46
30
—
—
29

RC-TE48
Stock-No. 5352

Farbe Colour			
blau blue			

Farbe Colour			
blau blue			

cm
34
40
56
56
74
80
—

RC-TE49
Stock-No. 5353

cm
46
36
28
24
—
—

RC-TE51
Stock-No. 5355

Farbe Colour			
blau blue			

Farbe Colour			
blau blue		—	

cm
54
48
34
30
—
—
35

RC-TE52
Stock-No. 5356

cm
59
51
39
31
—
—

RC-TE54
Stock-No. 5357

Farbe Colour			
blau blue			

Farbe Colour			
blau blue		—	

SAE	M4	DIN	FORD COIL	5 + 7 mm insert
------------	-----------	------------	------------------	------------------------

Cable Sets

RC-TE55 Stock-No. 5358				RC-TE56 Stock-No. 5359			
Farbe Colour				Farbe Colour			
blau blue				blau blue			
RC-TE58 Stock-No. 5361				RC-TE66 Stock-No. 2899			
Farbe Colour				Farbe Colour			
blau blue		—		blau blue		—	
RC-TE68 Stock-No. 2902				RC-TE75 Stock-No. 5362			
Farbe Colour				Farbe Colour			
blau blue				blau blue			











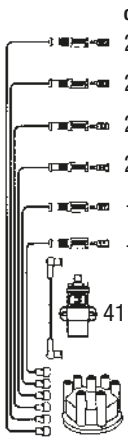

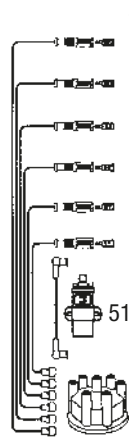













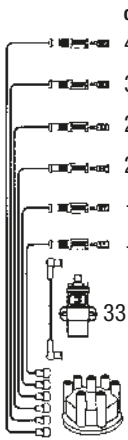

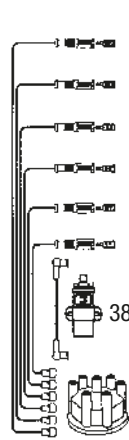













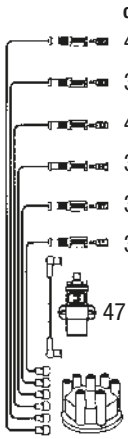

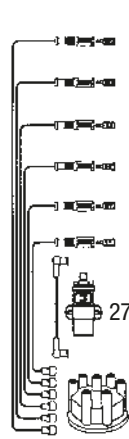



		SAE			M4		DIN		FORD COIL		5+7 mm insert
--	--	------------	--	--	-----------	--	------------	--	------------------	--	----------------------

Cable Sets

<p>RC-TE76 Stock-No. 5363</p>				<p>RC-TE78 Stock-No. 5364</p>			
Farbe Colour				Farbe Colour			
blau blue		—		blau blue			
<p>RC-TE79 Stock-No. 5381</p>				<p>RC-TE81 Stock-No. 9630</p>			
Farbe Colour				Farbe Colour			
blau blue		—		blau blue			
<p>RC-TE83 Stock-No. 8291</p>				<p>RC-TE86 Stock-No. 9641</p>			
Farbe Colour				Farbe Colour			
blau blue				blau blue			

SAE	M4	DIN	FORD COIL	5 + 7 mm insert
------------	-----------	------------	------------------	------------------------

Cable Sets

<p>cm</p> <ul style="list-style-type: none"> 27 25 25 27 - - 41 	 <p>RC-TE87 Stock-No. 9643</p>			<p>cm</p> <ul style="list-style-type: none"> 27 25 25 27 - - 51 	 <p>RC-TE88 Stock-No. 9529</p>		
<p>Farbe Colour</p>				<p>Farbe Colour</p>			
<p>blau blue</p>				<p>blau blue</p>			
<p>cm</p> <ul style="list-style-type: none"> 42 36 24 26 - - 33 	 <p>RC-TE93 Stock-No. 9649</p>			<p>cm</p> <ul style="list-style-type: none"> 60 68 84 90 - - 38 	 <p>RC-TE94 Stock-No. 3714</p>		
<p>Farbe Colour</p>				<p>Farbe Colour</p>			
<p>blau blue</p>				<p>blau blue</p>			
<p>cm</p> <ul style="list-style-type: none"> 48 38 40 30 36 30 47 	 <p>RC-TE95 Stock-No. 5382</p>			<p>cm</p> <ul style="list-style-type: none"> 26 34 32 48 - - 27 	 <p>RC-TE102 Stock-No. 2802</p>		
<p>Farbe Colour</p>				<p>Farbe Colour</p>			
<p>blau blue</p>				<p>blau blue</p>			

 <p>SAE</p>	 <p>M4</p>	 <p>DIN</p>	 <p>FORD COIL</p>	 <p>5+7 mm insert</p>
--	---	--	---	--

Cable Sets

cm
18
18
22
40
—
—
—

RC-TE105
Stock-No. 5294

cm
35
45
62
57
75
88
25

RC-TE109
Stock-No. 5296

Farbe Colour			
blau blue		—	

Farbe Colour			
blau blue			

cm
35
45
63
57
76
88
53

RC-TE111
Stock-No. 5297

cm
20 / 56
22 / 56
82
84
90
94
41 / 27

RC-TE119
Stock-No. 5298

Farbe Colour			
blau blue			

Farbe Colour			
blau blue			

cm
35
45
62
57
76
88
44

RC-TE120
Stock-No. 2816

cm
62
57
71
77
—
—

RC-TE121
Stock-No. 2818

Farbe Colour			
blau blue			

Farbe Colour			
blau blue		—	

SAE	M4	DIN	FORD COIL	5 + 7 mm insert

Cable Sets

cm
20 / 56
22 / 56
84
84
90
94
31 / 25

RC-TE132
Stock-No. 3075

cm
60
49
36
32
—
—
49

RC-TE141
Stock-No. 5774

Farbe Colour			
blau blue			

Farbe Colour			
blau blue			

cm
40
48
46
54
—
—
31

RC-TX02
Stock-No. 3715

cm
44
42
30
34
—
—

RC-TX03
Stock-No. 9664

Farbe Colour			
blau blue			

Farbe Colour		—	
blau blue		—	

cm
32
24
28
38
—
—
—

RC-TX05
Stock-No. 9681

cm
60
46
40
26
—
—
31

RC-TX06
Stock-No. 9684

Farbe Colour			
blau blue		—	

Farbe Colour			
blau blue			

SAE	M4	DIN	FORD COIL	5+7 mm insert

Cable Sets

<p>RC-TX07 Stock-No. 9687</p>				<p>RC-TX08 Stock-No. 9692</p>			
Farbe Colour				Farbe Colour			
blau blue				blau blue		—	
<p>RC-TX35 Stock-No. 9706</p>				<p>RC-TX71 Stock-No. 5384</p>			
Farbe Colour				Farbe Colour			
blau blue				blau blue			
<p>RC-TX80 Stock-No. 2915</p>				<p>RC-TX99A Stock-No. 0329</p>			
Farbe Colour				Farbe Colour			
blau blue		—		blau blue			

SAE	M4	DIN	FORD COIL	5 + 7 mm insert
------------	-----------	------------	------------------	------------------------

Cable Sets

cm
66
56
56
40
—
—
36

RC-TX117
Stock-No. 2908

cm
69
49
41
31
—
—

RC-TX118
Stock-No. 5383

Farbe Colour			
blau blue			

Farbe Colour			
blau blue		—	

cm
66
66
66
77
—
—
60

RC-VL601
Stock-No. 8223

cm
65
65
65
77
—
—
60

RC-VL602
Stock-No. 8226

Farbe Colour			
schwarz black			

Farbe Colour			
schwarz black			

cm
27
44
48
59
—
—
55

RC-VL604
Stock-No. 8464

cm
70
63
48
43
30
—
48

RC-VL605
Stock-No. 8468

Farbe Colour			
schwarz black			

Farbe Colour			
schwarz black			

SAE	M4	DIN	FORD COIL	5+7 mm insert

Cable Sets

cm
32
40
50
60
54

RC-VL606
Stock-No. 8469

cm
30
42
50
60
40

RC-VL607
Stock-No. 8472

Farbe Colour			
schwarz black			

Farbe Colour			
schwarz black			

cm
62
62
62
73
96

RC-VL608
Stock-No. 8481

cm
27
44
48
59
32

RC-VL609
Stock-No. 8500

Farbe Colour			
schwarz black			

Farbe Colour			
schwarz black			

cm
67
67
67
78
60

RC-VL611
Stock-No. 8840

cm
62
62
62
73
85

RC-VL612
Stock-No. 8891

Farbe Colour			
schwarz black			

Farbe Colour			
schwarz black			

SAE	M4	DIN	FORD COIL	5 + 7 mm insert
------------	-----------	------------	------------------	------------------------

Cable Sets

<p>cm 31 31 39 49 51 54 62</p>	<p>RC-VL613 Stock-No. 7116</p>			<p>cm 65 53 37 90 72 62 41</p>	<p>RC-VL614 Stock-No. 7117</p>		
<p>Farbe Colour</p>				<p>Farbe Colour</p>			
<p>schwarz black</p>				<p>schwarz black</p>			
<p>cm 25 39 45 57 90</p>	<p>RC-VL616 Stock-No. 7172</p>			<p>cm 62 62 62 73 54</p>	<p>RC-VL1301 Stock-No. 2564</p>		
<p>Farbe Colour</p>				<p>Farbe Colour</p>			
<p>schwarz black</p>				<p>schwarz black</p>			
<p>cm 27 44 48 59 32</p>	<p>RC-VL1302 Stock-No. 2993</p>			<p>cm 30 43 48 63 70 48</p>	<p>RC-VL1304 Stock-No. 6076</p>		
<p>Farbe Colour</p>				<p>Farbe Colour</p>			
<p>schwarz black</p>				<p>schwarz black</p>			

		SAE			M4			DIN			FORD COIL			5+7 mm insert
--	--	------------	--	--	-----------	--	--	------------	--	--	------------------	--	--	----------------------

Cable Sets

RC-VW208 Stock-No. 0939				RC-VW209 Stock-No. 0940			
Farbe Colour				Farbe Colour			
schwarz black				schwarz black			
RC-VW210 Stock-No. 0941				RC-VW211 Stock-No. 0942			
Farbe Colour				Farbe Colour			
schwarz black				schwarz black		—	
RC-VW214 Stock-No. 0945				RC-VW215 Stock-No. 0946			
Farbe Colour				Farbe Colour			
schwarz black				schwarz black			

SAE	M4	DIN	FORD COIL	5+7 mm insert

Cable Sets

		<p>RC-VW216 Stock-No. 0947</p>			<p>RC-VW217 Stock-No. 0948</p>		
Farbe Colour				Farbe Colour			
schwarz black				schwarz black			
		<p>RC-VW218 Stock-No. 0949</p>			<p>RC-VW219 Stock-No. 0950</p>		
Farbe Colour				Farbe Colour			
schwarz black				schwarz black			
		<p>RC-VW220 Stock-No. 0951</p>			<p>RC-VW223 Stock-No. 0954</p>		
Farbe Colour				Farbe Colour			
schwarz black				schwarz black			

SAE	M4	DIN	FORD COIL	5 + 7 mm insert
------------	-----------	------------	------------------	------------------------

Cable Sets

		<p>RC-VW225 Stock-No. 0956</p>				<p>RC-VW227 Stock-No. 0958</p>	
<p>Farbe Colour</p>				<p>Farbe Colour</p>			
<p>schwarz black</p>				<p>schwarz black</p>			
		<p>RC-VW230 Stock-No. 0961</p>				<p>RC-VW232 Stock-No. 0963</p>	
<p>Farbe Colour</p>				<p>Farbe Colour</p>			
<p>schwarz black</p>				<p>schwarz black</p>			
		<p>RC-VW233 Stock-No. 0964</p>				<p>RC-VW235 Stock-No. 0966</p>	
<p>Farbe Colour</p>				<p>Farbe Colour</p>			
<p>schwarz black</p>				<p>schwarz black</p>			

SAE	M4	DIN	FORD COIL	5+7 mm insert

Cable Sets

RC-VW236 Stock-No. 0967				RC-VW239 Stock-No. 0970			
Farbe Colour				Farbe Colour			
schwarz black		—		schwarz black			
RC-VW242 Stock-No. 8262				RC-VW244 Stock-No. 7358			
Farbe Colour				Farbe Colour			
schwarz black				schwarz black		—	
RC-VW246 Stock-No. 7363				RC-VW247 Stock-No. 7013			
Farbe Colour				Farbe Colour			
schwarz black				schwarz black		—	

SAE	M4	DIN	FORD COIL	5 + 7 mm insert
-----	----	-----	-----------	-----------------

Cable Sets

		<p>RC-VW249 Stock-No. 7015</p>			<p>RC-VW254 Stock-No. 7044</p>		
<p>Farbe Colour</p>				<p>Farbe Colour</p>			
<p>schwarz black</p>		<p>—</p>		<p>schwarz black</p>		<p>—</p>	
		<p>RC-VW902 Stock-No. 8618</p>			<p>RC-VW903 Stock-No. 8621</p>		
<p>Farbe Colour</p>				<p>Farbe Colour</p>			
<p>schwarz black</p>				<p>schwarz black</p>			
		<p>RC-VW904 Stock-No. 8622</p>			<p>RC-VW905 Stock-No. 8623</p>		
<p>Farbe Colour</p>				<p>Farbe Colour</p>			
<p>schwarz black</p>				<p>schwarz black</p>			

		<p>SAE</p>			<p>M4</p>		<p>DIN</p>		<p>FORD COIL</p>		<p>5+7 mm insert</p>
--	--	------------	--	--	-----------	--	------------	--	------------------	--	----------------------

Cable Sets

		<p>RC-VW907 Stock-No. 7302</p>			<p>RC-VW910 Stock-No. 7306</p>		
<p>Farbe Colour</p>				<p>Farbe Colour</p>			
<p>schwarz black</p>		<p>—</p>		<p>schwarz black</p>		<p>—</p>	
		<p>RC-VW912 Stock-No. 7318</p>			<p>RC-VW1101 Stock-No. 2565</p>		
<p>Farbe Colour</p>				<p>Farbe Colour</p>			
<p>schwarz black</p>				<p>schwarz black</p>			
		<p>RC-VW1102 Stock-No. 2569</p>			<p>RC-VW1103 Stock-No. 2573</p>		
<p>Farbe Colour</p>				<p>Farbe Colour</p>			
<p>schwarz black</p>				<p>schwarz black</p>			

		<p>SAE</p>			<p>M4</p>		<p>DIN</p>		<p>FORD COIL</p>		<p>5 + 7 mm insert</p>
--	--	------------	--	--	-----------	--	------------	--	------------------	--	------------------------

Cable Sets

		<p>RC-VW1104 Stock-No. 2576</p>			<p>RC-VW1105 Stock-No. 6797</p>		
<p>Farbe Colour</p>				<p>Farbe Colour</p>			
<p>schwarz black</p>				<p>schwarz black</p>			
		<p>RC-VW1106 Stock-No. 6867</p>			<p>RC-VW1107 Stock-No. 44227</p>		
<p>Farbe Colour</p>				<p>Farbe Colour</p>			
<p>schwarz black</p>				<p>schwarz black</p>			
		<p>RC-VW1108 Stock-No. 44253</p>			<p>RC-VW1109 Stock-No. 44256</p>		
<p>Farbe Colour</p>				<p>Farbe Colour</p>			
<p>schwarz black</p>				<p>schwarz black</p>			

SAE	M4	DIN	FORD COIL	5+7 mm insert

Cable Sets

cm
32
49
44
47
—
—
—
—
—

RC-VW110
Stock-No. 44316

cm
50
55
61
69
—
—
—
52

RC-VX402
Stock-No. 0973

Farbe Colour			
schwarz black		—	

Farbe Colour			
schwarz black			

cm
52
52
62
62
—
—
—
75

RC-VX415
Stock-No. 0986

cm
48
41
30
25
—
—
—

RC-VX1201
Stock-No. 7704

Farbe Colour			
schwarz black			

Farbe Colour			
schwarz black		—	

cm
60
47
43
34
—
—
—
—

RC-VX1202
Stock-No. 6983

cm
103
103
67
73
—
—
—











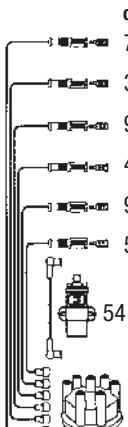

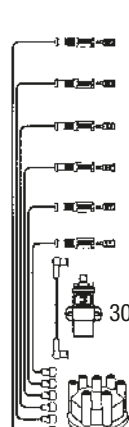













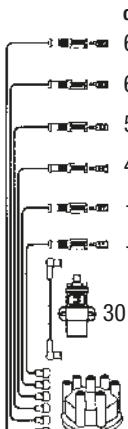
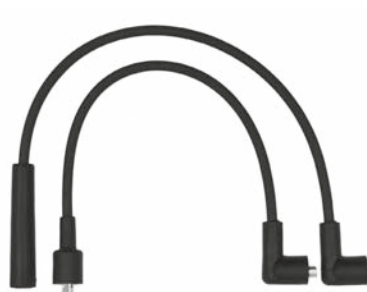
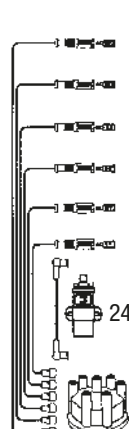













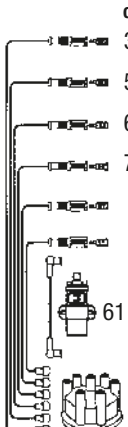

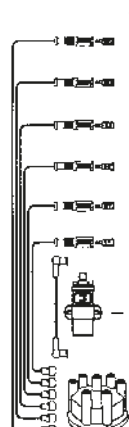

RC-ZE02
Stock-No. 3941

Farbe Colour			
schwarz black		—	

Farbe Colour			
blau blue		—	

SAE	M4	DIN	FORD COIL	5 + 7 mm insert
------------	-----------	------------	------------------	------------------------

Cable Sets

<p>cm</p> <ul style="list-style-type: none"> 76 36 90 40 96 52 54 	 <p>RC-ZE06 Stock-No. 9844</p>			<p>cm</p> <ul style="list-style-type: none"> 56 48 38 28 — — 30 	 <p>RC-ZE07 Stock-No. 9846</p>		
<p>Farbe Colour</p>				<p>Farbe Colour</p>			
<p>blau blue</p>				<p>blau blue</p>			
<p>cm</p> <ul style="list-style-type: none"> 68 64 52 42 — — 30 	 <p>RC-ZE08 Stock-No. 9848</p>			<p>cm</p> <ul style="list-style-type: none"> 68 64 52 42 — — 24 	 <p>RC-ZE11 Stock-No. 9851</p>		
<p>Farbe Colour</p>				<p>Farbe Colour</p>			
<p>blau blue</p>				<p>blau blue</p>			
<p>cm</p> <ul style="list-style-type: none"> 36 50 62 74 — — 61 	 <p>RC-ZE17 Stock-No. 2917</p>			<p>cm</p> <ul style="list-style-type: none"> 38 28 20 16 — — 	 <p>RC-ZE21 Stock-No. 9856</p>		
<p>Farbe Colour</p>				<p>Farbe Colour</p>			
<p>blau blue</p>				<p>blau blue</p>		<p>—</p>	

	<p>SAE</p>		<p>M4</p>		<p>DIN</p>		<p>FORD COIL</p>		<p>5+7 mm insert</p>
---	------------	---	-----------	---	------------	--	------------------	---	----------------------

Cable Sets

cm
70
38
50
48
—
—
—
—
—
—

RC-ZE23
Stock-No. 9857

cm
103
62
107
48
119
50
—
—
—

RC-ZE28
Stock-No. 9874

Farbe Colour			
blau blue		—	

Farbe Colour			
blau blue		—	

cm
23
29
35
31
—
—
—
—
—

RC-ZE30
Stock-No. 9881

cm
105
64
105
46
125
50
58
—
—
—

RC-ZE31
Stock-No. 9890

Farbe Colour			
blau blue			

Farbe Colour			
blau blue			

cm
111
66
113
44
121
34
—
—
—

RC-ZE32B
Stock-No. 8863

cm
54
52
38
34
—
—
—
—
—

RC-ZE36
Stock-No. 9895

Farbe Colour			
blau blue		—	

Farbe Colour			
blau blue		—	

SAE	M4	DIN	FORD COIL	5 + 7 mm insert
-----	----	-----	-----------	-----------------

Cable Sets

	<p style="text-align: center;">RC-ZE37 Stock-No. 9898</p>				<p style="text-align: center;">RC-ZE53 Stock-No. 8647</p>		
Farbe <i>Colour</i>				Farbe <i>Colour</i>			
blau <i>blue</i>		—		blau <i>blue</i>		—	
	<p style="text-align: center;">RC-ZE63 Stock-No. 5388</p>				<p style="text-align: center;">RC-ZE94A Stock-No. 9903</p>		
Farbe <i>Colour</i>				Farbe <i>Colour</i>			
blau <i>blue</i>				blau <i>blue</i>			
	<p style="text-align: center;">RC-ZE97A Stock-No. 9905</p>				<p style="text-align: center;">RC-ZE98 Stock-No. 9907</p>		
Farbe <i>Colour</i>				Farbe <i>Colour</i>			
blau <i>blue</i>				blau <i>blue</i>			

SAE

M4

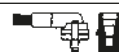
DIN

FORD COIL

5+7 mm insert

Cable Sets

cm
76
62
56
44
—
—
44

RC-ZX14
Stock-No. 9914

cm
63
49
45
31
—
—
54

RC-ZX15
Stock-No. 9916

Farbe Colour			
blau blue			

Farbe Colour			
blau blue			

cm
72
52
48
34
—
—
76

RC-ZX16
Stock-No. 9917

cm
56
48
40
34
—
—
58

RC-ZX18
Stock-No. 9920

Farbe Colour			
blau blue			

Farbe Colour			
blau blue			

cm
68
66
52
48
—
—
50

RC-ZX19
Stock-No. 9922

cm
61
59
45
43
—
—
—

RC-ZX29
Stock-No. 9925

Farbe Colour			
blau blue			

Farbe Colour			
blau blue		—	

SAE	M4	DIN	FORD COIL	5 + 7 mm insert
-----	----	-----	-----------	-----------------

Cable Sets

<p>cm</p> <p>54</p> <p>44</p> <p>32</p> <p>30</p> <p>—</p> <p>—</p> <p>—</p> <p>—</p> <p>—</p> <p>—</p>	<p>RC-ZX49 Stock-No. 8932</p>			<p>cm</p> <p>45</p> <p>35</p> <p>23</p> <p>21</p> <p>—</p> <p>—</p> <p>—</p> <p>—</p> <p>—</p> <p>—</p>	<p>RC-ZX52 Stock-No. 8839</p>		
<p>Farbe</p> <p>Colour</p>				<p>Farbe</p> <p>Colour</p>			
<p>blau</p> <p>blue</p>		<p>—</p>		<p>blau</p> <p>blue</p>		<p>—</p>	
<p>cm</p> <p>70</p> <p>52</p> <p>46</p> <p>30</p> <p>—</p> <p>—</p> <p>—</p> <p>—</p> <p>42</p>	<p>RC-ZX99A Stock-No. 9932</p>						
<p>Farbe</p> <p>Colour</p>							
<p>blau</p> <p>blue</p>							



SAE



M4



DIN





FORD COIL





5+7mm insert



Einzelzündleitungen

	Stock-No.		Cylinder													
			1	2	3	4	5	6	7	8	9	10	11	12		
RC-AD202	0502	215 040		210 060	210 060	210 060	210 060									
RC-AD208	0508	214 050		213 085	213 085	213 070	213 055	213 045								
RC-AD209	0509	215 040		211 060	211 080	211 080	211 080									
RC-AD210	0510	215 040		210 040	210 050	210 050	210 060									
RC-AD211	0511	214 050		211 080	211 080	211 080	211 060	211 060								
RC-AD216	0516	214 040		211 080	211 070	211 070	211 050	211 050								
RC-AD218	0518			296 045	296 045	296 045										
RC-AD219	0519	215 070		210 060	210 060	210 060	210 060									
RC-AR406	0530	334 060		410 060	410 060	410 070	410 080									
RC-AR414	0538	414 070		410 050	410 060	410 060	410 060	411 080	411 080	411 080	411 100					
RC-AT402	0540	334 050		368 030	368 030	368 030	368 040									
RC-AT404	0542	334 060		368 030	368 040	368 050	368 060									
RC-AT405	0543	334 030		368 030	368 040	368 030	368 030									
RC-BW210	0553	232 070		226 047	226 047	226 060	226 070									
RC-BW213	0556	232 080		226 026	226 035	226 047	226 055									
RC-BW232	0576	214 070		221 095	221 105	221 120	221 120	221 130	221 140							
RC-CR304	8286	334 050	346 050	427 070	427 050	427 070	427 060	427 080	427 070							
RC-CR306	8288	304 095	334 040	424 050	424 050	424 060	424 070	424 070	424 080	424 080	424 080					
RC-CR310	8294	424 040		424 030	424 030	424 030	424 040									
RC-CR601	8471			731 040	731 060	731 060	731 080									
RC-CT605	7389	775 060		724 040	724 060	724 070	724 080									
RC-CT615	7285			766 030	766 040	766 050	766 060									
RC-DW1201	2996	424 040		424 070	424 070	424 050	424 040									
RC-DW1206	5976	432 040		423 050	423 050	423 060	423 070									
RC-DW304	7367	334 050		411 050	411 050	410 050										
RC-DW403	0595	424 050		424 070	424 060	424 050	424 050									
RC-ED1202	0350	584 040		486 070	486 060	486 050	486 040									
RC-ED1203	5904	334 050		411 070	411 060	411 070										
RC-EF1203	9169	334 050		411 040	411 040	411 060	411 060									
RC-EH1201	9057	334 050		411 050	411 060	411 080	411 080									
RC-EM1203	9120	414 050		411 100	411 090	411 090	410 100									
RC-EM1206	5900	346 050		411 070	411 080	411 080	411 100									
RC-EM1207	5917	334 090		427 070	427 090	427 100	427 100									
RC-EN1203	9027	334 040		411 080	411 070	411 060	411 050									
RC-ES1202	9031	414 030		410 060	410 060	410 050	410 060									
RC-ET1202	9059			411 060	427 060	427 040	427 050									
RC-ET1203	9072	334 070		411 040	411 030	411 020	411 020									
RC-ET1204	9076	334 030		411 020	411 020	411 030	411 040									
RC-EZ1208	9133	414 050		423 080	423 060	423 060	423 040									
RC-EZ1210	5903			411 070	411 060	411 050	411 050									
RC-EZ1211	6365			411 070	411 070	411 050	411 050									
RC-EZ12156	44273			411 060	411 060	411 050	411 040									
RC-FD1205	2584			803 080	803 080	803 100	803 100									
RC-FD1207	6984			407 020	407 040	407 050	407 060									
RC-FD1210	6317			471 030	471 040	471 050	471 050									
RC-FD508	0603	414 100		411 060	411 060	411 060	411 080	411 080	411 090							
RC-FD532	0627	334 060		410 060	410 060	410 080	410 090									
RC-FD538	0633			577 061	577 061	577 080	577 080									
RC-FD544	0639			516 080	516 080	516 100	516 100									
RC-FD546	0641			513 050	513 050	513 035	513 020									
RC-FD804	8537	414 060		410 060	410 070	410 070	410 080									
RC-FD807	8541			297 040	297 040	597 025	597 020									
RC-FD808	8542			597 050	597 050	297 040	597 025									
RC-FT1101	44236	334 080	334 070	411 060	411 070	411 070	411 080	411 070	411 080	411 090	411 100					
RC-FT1204	6969	414 050		410 060	410 080											
RC-FT1205	6980	414 040		410 070	410 080											
RC-FT201	0643			272 055	272 055	272 045	272 030									
RC-FT414	0660			410 070	410 070											



Einzelzündleitungen

	Stock-No.		Cylinder														
			1	2	3	4	5	6	7	8	9	10	11	12			
RC-FT417	0664	414 030		410 030	410 040	410 040	410 050										
RC-FT420	0667	334 060		410 040	410 050	410 060	410 070										
RC-FT435	0682	334 040		410 040	410 040	410 050	410 060										
RC-FT442	0689			410 080	410 090												
RC-FT444	0691			427 060	427 050	427 040	427 040										
RC-FT446	0693	334 080		410 030	410 030	410 040	410 040										
RC-FT638	7291	334 040		410 030	410 040	410 040	410 060										
RC-GM1202	5557	424 040		424 030	424 030	424 030	424 030										
RC-HD1202	5506	102 055		427 040	427 050	427 050	427 070										
RC-HD301	8300	334 050		411 060	411 050	411 050	411 040										
RC-HD404	0706	334 040		427 040	427 050	427 050	427 050	427 060	427 070								
RC-HD407	0709			359 040	359 040	359 050	359 065										
RC-HD408	0710	334 050		411 080	411 070	411 070	411 060										
RC-HD411	0713	334 020		411 090	411 070	411 070	411 060										
RC-HE53	8573			486 080	486 070	486 060	486 050										
RC-HE80	8379			486 080	486 070	486 070	486 050										
RC-JG1202	5409	346 020	346 030	368 050	411 030	411 030	411 030	411 040	411 040	368 040	411 040	411 030	411 030	411 040	411 040	411 050	411 050
RC-JG1203	7703	334 020	334 020	368 030	368 030	368 030	368 040	368 040	411 030	411 030	411 030	411 040	411 040	411 050	411 050	411 050	411 050
RC-JG1205	2475	334 040		410 070	410 070	410 070	410 080	410 090	410 100								
RC-KA401	0714	334 060	368 040	411 040	411 040	411 060	411 070										
RC-KA402	0715	334 050		423 040	423 050	423 060	423 070										
RC-LC1201	5408	334 060		411 070	411 070	411 050	411 050										
RC-LC1205	5590	334 040		423 040	423 050	423 060	423 070										
RC-LC610	8528	334 050		410 070	410 070	410 080	410 080										
RC-LD1205	6019			424 030	424 030	424 040	424 060										
RC-LD301	7068	334 030		411 050	411 060	411 070	411 070										
RC-LD302	7104	414 070		410 040	410 050	410 050	410 060										
RC-MB203	0738			294 055	294 050	294 050	294 050										
RC-ME54	9296	334 040		411 070	411 080	411 080	411 100										
RC-ME74	5071			427 080	427 080	427 090	427 090										
RC-MX1201	7702	334 050		368 030	368 030	368 030	368 030										
RC-MX1202	7700			427 050	427 060	427 060	427 070										
RC-MX401	0759	334 040		411 030	411 040	411 040	411 050										
RC-NE08	9405			486 070	486 060	486 050	486 040										
RC-NE09	9985			351 065	351 060	351 045	351 040										
RC-NE29	5764	334 060		411 100	411 090	411 070	411 070	411 050	411 040								
RC-NX11	5075			486 060	486 060	486 050	486 040										
RC-NX71	9464	414 050		411 050	411 060	411 060	411 080										
RC-OP1202	2590	334 070		410 050	410 050	410 060	410 060										
RC-OP1206	4061			481 080	481 060	481 070	481 040	481 060	481 030								
RC-OP1208	4069			479 030	479 050	479 050	479 055										
RC-OP1208	4069			479 030	479 050	479 050	479 055										
RC-OP1209	6257	451 050		479 040	479 050	479 070	479 070										
RC-OP1211	8822			481 050	481 060	481 070	481 080										
RC-OP1213	8745	451 030		470 040	469 040	470 060	469 060										
RC-OP1219	6257	451 050		479 040	479 050	479 070	479 070										
RC-OP1219	1585	451 050		469 040	469 060	470 040	470 060										
RC-OP204	0769	451 050		481 070	481 060	481 050	481 040										
RC-OP301	8265	334 060		410 060	410 060	410 070	410 070										
RC-OP402	0772	414 050		410 050	410 060	410 070	410 070										
RC-OP403	0773	334 090		410 080	410 080	410 080	410 080										
RC-OP411	0781	414 100		410 040	418 070	418 090	418 090										
RC-OP426	0796	414 070		410 040	418 070	418 090	418 090										
RC-OP427	0797	414 050		418 090	418 075	418 070	410 050										
RC-OP430	0800	450 100		470 060	470 040	469 060	469 040										
RC-OP432	0802	451 030		470 070	470 070	470 050	470 040										
RC-OP434	0804			470 050	470 050	470 040	470 025										
RC-OP436	0806	451 050		470 070	470 070	470 050	470 040										







Einzelzündleitungen

	Stock-No.		Cylinder													
			1	2	3	4	5	6	7	8	9	10	11	12		
RC-OP438	0808		481 070	481 060	481 060	481 040										
RC-OP440	0810		481 050	481.050	481.030	481.030										
RC-OP442	0812	450 030	481 060	481 040	482 060	482 040										
RC-OP444	0814	451 030	479 070	479 070	479 050	479 040										
RC-OP447	0817	414 030	418 075	418 070	418 060	418 050										
RC-OP448	0818	450 050	481 060	481 040	482 060	482 040										
RC-OP450	0820		481 070	481 070	481 070	481 060	481 060	481 050								
RC-OP455	0825	424 040	424 040	419 050	419 070	419 070										
RC-OP459	0829	414 050	410 030	410 040	410 060	410 060	410 070	410 090								
RC-OP465	0835		481 090	481 080	481 080	481 070										
RC-PG603	8495	775 090	767 060	767 070	767 080	768 090										
RC-PG615	7176	710 060	767 060	767 070	767 080	767 090										
RC-PG617	7275		731 030	731 050	731 060	731 070										
RC-RN1201	6981	414 040	368 030	368 030	368 030	368 030										
RC-RN1202	4053		643 030	643 030	643 040	643 050										
RC-RN603	8185		643 060	643 040	643 040	643 050										
RC-RN623	8493	775 090	725 030	725 040	725 040	725 060										
RC-RN632	8510	687 070	724 050	724 050	724 070	724 070										
RC-RN637	7368	775 050	724 040	724 050	724 070	724 070										
RC-RN658	7200		643 060	643 030	643 030	643 040										
RC-RV1201	2585	414 020	561 060	561 060	561 050	561 040										
RC-RV1202	7705		561 040	561 040												
RC-RV1207	2577	334 070	410 050	410 060	410 060	410 060	411 080	411 080	411 080	411 100						
RC-RV304	8269	334 050	411 050	411 050	411 070	411 070										
RC-RV309	8279	334 060	410 060	411 070	410 060	411 080	410 060	411 090	410 070	411 090						
RC-RV315	8299		424 070	424 070	424 060	424 050										
RC-RV323	7079		410 060	411 080	410 080	411 070	410 060	411 060	411 060	411 080						
RC-RV401	0876	414 040	368 030	368 040	368 050											
RC-RV404	0879	334 040	427 040	427 060	427 070	427 080										
RC-RV406	0881	334 040	411 030	411 030	411 030	411 030										
RC-RV412	0887	334 080	411 040	411 060	411 040	411 060										
RC-RV413	0888	584 080	561 060	561 060	561 050	561 040										
RC-RV414	0889	411 040	411 060	411 060	411 040	411 040										
RC-RV415	0890	586 040	561 060	561 050	561 040	561 040										
RC-RV603	8496		486 080	486 070	486 060	486 050										
RC-SB408	0898		481 050	481 050	481 060	481 070	481 080	481 090								
RC-SD1202	44254		411 030	411 040	411 040	411 050										
RC-SD401	0899	414 050	410 030	410 040	410 050	410 060										
RC-SE02	8312	334 050	353 070	353 070	353 060	353 050										
RC-SE83	8748	414 050	423 070	423 060	423 060	423 060										
RC-SE93	8073	334 060	411 070	411 070	411 050	411 050										
RC-SE94	8059		353 060	353 050	353 040	353 040										
RC-ST201	0901	215 060	211 080	211 080	211 050	211 050										
RC-ST204	7061		293 060	293 060	293 040	293 020										
RC-ST405	0906	414 060	410 040	410 050	410 050	410 060										
RC-ST901	7303		236 085	236 070	236 060	236 060										
RC-ST902	7313	214 040	211 070	211 060	211 060	211 040										
RC-TE141	5774	334 050	411 070	427 040	427 050	427 060										
RC-TE83	8291	334 060	410 030	410 030	410 030	410 030										
RC-TE87	9643	334 050	417 030	417 030	417 030	417 030										
RC-TE93	9649		411 050	411 050	411 030	411 040										
RC-VL605	8468	777 050	641 070	641 070	641 050	641 050	641 030									
RC-VW1105	7044		293 060	293 060	293 040	293 020										
RC-VW201	0932		204 100	204 090	204 090	204 070	204 070	204 060								
RC-VW203	0934		293 065	293 065	293 050	293 030										
RC-VW203	0934		293 065	293 065	293 050	293 030										
RC-VW206	0937	215 060	211 050	211 050	211 040	211 040										
RC-VW207	0938	215 040	210 030	210 040	210 040	210 050										

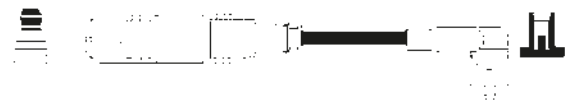
Einzelzündleitungen

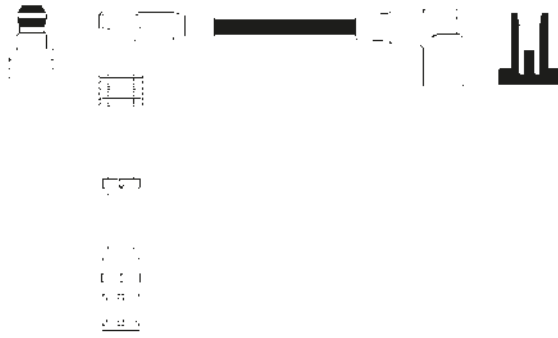







	Stock-No.		Cylinder													
			1	2	3	4	5	6	7	8	9	10	11	12		
RC-VW208	0939	215 060		211 050	211 050	211 060	211 070									
RC-VW209	0940	214 040		210 060	210 060	210 050	210 030	210 030	210 030							
RC-VW210	0941	214 060		211 040	211 060	211 060	211 070									
RC-VW214	0945	214 040		213 085	213 080	213 070	213 070									
RC-VW215	0946	214 060		210 040	210 040	210 050	210 060									
RC-VW216	0947	214 060		211 050	211 050	211 060	211 070									
RC-VW217	0948	414 030		410 060	410 060	410 080	410 080									
RC-VW219	0950	214 040		211 060	211 050	211 050	211 025									
RC-VW223	0954	214 060		204 100	204 090	204 090	204 080	204 080	204 070							
RC-VW225	0956	215 060		295 070	295 055	295 040	295 030									
RC-VW227	0958	214 060		271 065	271 065	271 065	271 065									
RC-VW230	0961	217 055		295 050	295 040	295 040	295 030									
RC-VW232	0963	214 040		131 060	131 050	131 040	131 040									
RC-VW233	0964	214 040		211 070	211 060	211 050	211 040									
RC-VW235	0966			293 080	293 080	293 070	293 070	293 060								
RC-VW236	0967			298 070	298 070	298 070	298 070									
RC-VW239	0970	214 060		213 070	213 070	213 070	213 070									
RC-VW242	8262	214 040		210 030	210 040	210 050	210 060									
RC-VW246	7363	215 060		210 060	210 050	210 040	210 040									
RC-VW249	7015			293 065	293 060	293 050	293 030									
RC-VW254	7044			293 060	293 060	293 040	293 020									
RC-VW902	8618			211 080	211 080	211 080	211 050	211 050								
RC-VW903	8621	214 060		211 070	211 060	211 050	211 040									
RC-VW904	8622	215 060		210 060	210 050	210 040	210 040									
RC-VW905	8623	217 045		210 060	210 060	210 060	210 060									
RC-VW907	7302			144 090	144 070	144 060	144 060									
RC-VW910	7306			131 050	131 050	131 040	131 030									
RC-VW912	7318	214 060		295 070	295 055	295 040	295 030									
RC-VX1202	6983			481 040	481 050	481 050	481 070									
RC-VX402	0973	334 060		423 050	423 060	423 070	423 070									
RC-VX415	0986	334 080		410 070	410 070	410 060	410 060									
RC-ZE02	3941	334 060	334 070	411 060	411 060	411 070	411 070									
RC-ZE06	9844	334 060		411 090	411 090	411 080	411 050	411 050	411 050							
RC-ZE08	9848	334 040		411 070	411 060	411 050	411 040									
RC-ZE21	9856			444 050	444 040	444 030	444 030									
RC-ZE23	9857			411 060	411 060	411 050	411 040									
RC-ZE63	5388	414 060		411 050	411 050	411 060	411 070									
RC-ZE94A	9903	334 080		410 060	410 060	410 080	410 090									
RC-ZE98	9907	414 030		411 080	411 070	411 070	411 060									
RC-ZX15	9916	334 060		444 050	444 060	444 070	444 080									
RC-ZX16	9917	414 075		411 070	411 050	411 050	411 030									
RC-ZX18	9920	414 070		444 070	444 060	444 060	444 050									
RC-ZX19	9922	408 060		411 050	411 050	411 060	411 070									
RC-ZX29	9925			360 075	360 070	360 060	360 060									
RC-ZX99A	9932	334 050		411 070	411 050	411 050	411 030									

Einzelzündleitungen









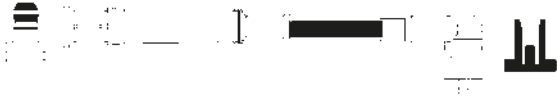

	
<p>131 030 131 060 131 040 131 070 131 050 131 075</p>	<p>144 050 144 090 144 060 144 070</p>
	
<p>202 060</p>	<p>204 060 204 090 204 070 204 100 204 080</p>
	
<p>206 080 206 085 206 100</p>	<p>207 040 207 045 207 060</p>
	
<p>210 030 210 060 210 040 210 050</p>	<p>211 025 211 060 211 040 211 070 211 050 211 080</p>

 SAE	 M4	 DIN	 FORD COIL	 5+7mm insert
---	--	---	--	--

Einzelzündleitungen







					
213 045 213 055 213 070	213 080 213 085			214 040 214 050 214 060	214 070
					
215 040 215 060 215 070					217 045 217 055
					
221 040 221 048 221 050	221 054 221 060 221 070	221 080 221 095 221 105	221 120 221 130 221 140	226 026 226 035 226 047	226 055 226 060 226 070
					
229 030 229 080 229 085					232 070 232 080

 SAE	 M4	 DIN	 FORD COIL	 5 + 7 mm insert
---	--	---	--	---

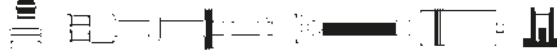
	
<p>236 060 236 070 236 085</p>	<p>239 032 239 050 239 060</p>
	
<p>271 065</p>	<p>272 030 272 045 272 055</p>
	 <p>    </p>
<p>293 020 293 050 293 070 293 030 293 060 293 080 293 040 293 065</p>	<p>294 050 294 055</p>
	 <p>  </p>
<p>295 030 295 055 295 040 295 070 295 050</p>	<p>296 045</p>









 SAE	 M4	 DIN	 FORD COIL	 5+7mm insert
---	--	---	--	--

Einzelzündleitungen

	
<p>297 040</p>	<p>298 070</p>
	
<p>334 020 334 050 334 080 334 030 334 060 334 090 334 040 334 070</p>	<p>346 020 346 030 346 050</p>
	
<p>351 040 351 065 351 045 351 060</p>	<p>353 040 353 070 353 050 353 060</p>
	
<p>359 040 359 050 359 065</p>	<p>360 060 360 070 360 075</p>









 SAE	 M4	 DIN	 FORD COIL	 5 + 7 mm insert
---	--	---	--	---

Einzelzündleitungen

	
<p>368 030 368 060 368 040 368 050</p>	<p>410 030 410 060 410 090 410 040 410 070 410 100 410 050 410 080</p>
	
<p>411 020 411 050 411 080 411 030 411 060 411 090 411 040 411 070 411 100</p>	<p>414 020 414 050 414 075 414 030 414 060 414 100 414 040 414 070</p>
	
<p>417 030</p>	<p>418 070 418 075 418 090</p>
	
<p>419 050 419 070</p>	<p>423 040 423 070 423 050 423 080 423 060</p>







 SAE	 M4	 DIN	 FORD COIL	 5+7mm insert
---	--	---	--	--

Einzelzündleitungen

	
<p>424 030 424 060 424 040 424 070 424 050</p>	<p>427 040 427 070 427 100 427 050 427 080 427 060 427 090</p>
	
<p>444 030 444 060 444 040 444 070 444 050 444 080</p>	<p>450 030 450 050 450 100</p>
	
<p>451 030 451 050</p>	<p>469 040 469 060</p>
	
<p>470 025 470 060 470 040 470 070 470 050</p>	<p>479 030 479 055 479 040 479 070 479 050</p>



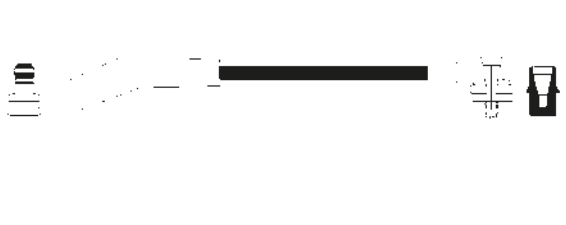
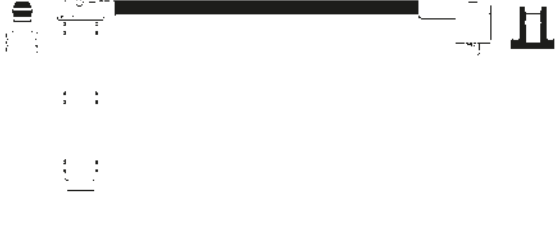





 SAE	 M4	 DIN	 FORD COIL	 5 + 7 mm insert
---	--	---	--	---

Einzelzündleitungen

	
<p>481 030 481 060 481 090 481 040 481 070 481 050 481 080</p>	<p>482 040 482 060</p>
	
<p>486 040 486 070 486 050 486 080 486 060</p>	<p>513 020 513 035 513 050</p>
	
<p>516 080 516 100</p>	<p>561 040 561 050 561 060</p>
	
<p>577 061 577 080</p>	<p>584 040 584 080</p>



 SAE	 M4	 DIN	 FORD COIL	 5+7mm insert
---	--	---	--	--

Einzelzündleitungen

	
<p>597 020 597 025 597 050</p>	<p>608 070 608 080</p>
	
<p>641 030 641 050 641 070</p>	<p>643 030 643 060 643 040 643 050</p>
	
<p>724 040 724 070 724 050 724 080 724 060</p>	<p>725 030 725 040 725 060</p>
	
<p>731 030 731 060 731 040 731 070 731 050 731 080</p>	<p>766 030 766 060 766 040 766 050</p>

 SAE	 M4	 DIN	 FORD COIL	 5 + 7 mm insert
---	--	---	--	---

Einzelzündleitungen

	
<p>767 060 767 070 767 080</p>	<p>775 050 775 060 775 090</p>
	
<p>777 050</p>	

 SAE	 M4	 DIN	 FORD COIL	 5+7mm insert
---	--	---	--	--

Anmerkung zur Zündkabelvergleichsliste:

Diese Liste dient nur zur Information. Wegen der Unterschiede von Konstruktion, Werkstoffen usw. haben einige Zündkabelhersteller keine miteinander übereinstimmenden Zündkabel, Zündkabelsteckverbindungen und Zündkabelängen. Siehe unsere Empfehlungen für die richtige Anwendung der Zündkabel und Zündkabelsätze.

Note on comparative list of ignition cables:

This list is for information purposes only. Due to the differences in design, materials etc. some ignition cable manufacturers have no matching ignition cables, ignition cable plug connections and ignition cable lengths.

See our recommendation for the proper use of ignition cables and ignition cable sets.

Замечание к таблице сравнения проводов зажигания:

Данная таблица носит исключительно информативный характер. Из-за отличий в конструкциях, материалах, некоторые производители проводов зажигания не имеют одинаковых с другими проводов зажигания, свечных наконечников и соответствующих размеров проводов.

См. наши рекомендации для правильного применения проводов зажигания и комплектов высоковольтных проводов.

Uwaga do listy zmienionych numerów katalogowych:

Lista ta służy jedynie do celów informacyjnych. Z uwagi na różnice w projekcie, materiałach itp. wyroby niektórych wytwórców nie mają odpowiedników.

Por. nasze zalecenia dotyczące właściwego użycia przewodów wysokiego napięcia i zestawów przewodów wysokiego napięcia.

Nota para la tabla de equivalencias de los cables de alta tensión

Esta lista se facilita a título indicativo. Aparte de sus diferencias en el diseño, los materiales utilizados, etc., los cables de alta tensión producidos por los fabricantes no tienen exactamente las mismas características. Consultar el catálogo de aplicación para decidir qué cable de alta tensión corresponde a una determinada aplicación.

Nota alla tabella comparativa:

Questa tabella deve considerarsi come indicativa: a causa di differenze nel design, nei materiali ecc. i cavi di diversi produttori possono non corrispondere. Si raccomanda di consultare la sezione applicativa per una verifica più accurata.



AUSTIN	→ NGK
GHT 184	RC-AT402
GHT 189	RC-AT402
GHT 190	RC-AT402
GHT 192	RC-AT402
GHT 204	RC-AT402
GHT 205	RC-AT404
GHT 293	RC-AT405
BBT	→ NGK
ZK 135	RC-VL606
ZK 149	RC-VL604
ZK 150	RC-ST406
ZK 1507	RC-CR601
ZK 1531	RC-CT601
ZK 1550	RC-CR602
ZK 16100	RC-ET1229
ZK 305	RC-VW215
ZK 306	RC-VW208
ZK 307	RC-VW218
ZK 311	RC-AD212
ZK 312	RC-AD211
ZK 318	RC-VW208
ZK 319	RC-AD211
ZK 320	RC-VW208
ZK 324	RC-AD211
ZK 325	RC-AD210
ZK 410	RC-MB215
ZK 414	RC-MB211
ZK 415	RC-MB207
ZK 416	RC-MB216
ZK 417	RC-MB209
ZK 418	RC-MB206
ZK 434	RC-MB214
ZK 721	RC-OP419
ZK 729	RC-OP412
ZK 733	RC-OP463
ZK 734	RC-OP204
ZK 902	RC-BW232
ZK 903	RC-BW218
ZK 905	RC-BW222
ZK 908	RC-BW231
ZK 909	RC-BW233
BERU	→ NGK
0 300 811 356	221 120
0 300 811 357	221 130
0 300 811 359	RC-BW233
0 300 811 362	226 035
0 300 811 363	226 035
0 300 811 364	226 055

BERU	→ NGK
0 300 811 365	226 055
0 300 811 371	RC-BW223
0 300 811 383	RC-MB211
0 300 811 446	294 055
0 300 811 447	294 050
0 300 811 480	210 030
0 300 811 481	210 040
0 300 811 482	210 050
0 300 811 483	210 060
0 300 811 485	211 040
0 300 811 486	211 050
0 300 811 487	211 060
0 300 811 488	211 070
0 300 811 489	211 080
0 300 811 490	214 040
0 300 811 491	214 060
0 300 811 493	215 040
0 300 811 494	215 060
0 300 811 716	293 020
0 300 811 764	131 050
0 300 811 765	131 040
0 300 811 766	131 030
0 300 811 801	295 030
0 300 811 802	295 040
0 300 811 803	295 055
0 300 811 861	236 060
0 300 811 862	236 070
0 300 811 863	236 085
0 300 811 902	293 040
0 300 811 975	296 045
0 300 811 976	296 045
0 300 811 994	247 030
0 300 890 094	RC-PS1102
0 300 890 115	RC-BW230
0 300 890 117	RC-BW223
0 300 890 121	RC-BW231
0 300 890 125	RC-BW233
0 300 890 154	RC-BW232
0 300 890 215	RC-BW223
0 300 890 219	RC-BW218
0 300 890 220	RC-PS1103
0 300 890 298	RC-VW223
0 300 890 304	RC-VW217
0 300 890 309	RC-PS1106
0 300 890 404	RC-AD212
0 300 890 405	RC-BW1201
0 300 890 408	RC-PS1101
0 300 890 425	RC-BW1101
0 300 890 432	RC-VW1102
0 300 890 435	RC-MB218
0 300 890 437	RC-MB206
0 300 890 463	RC-MB216



BERU	→ NGK
0 300 890 464	RC-AD1103
0 300 890 466	RC-MB1105
0 300 890 467	RC-BW231
0 300 890 470	RC-MB208
0 300 890 473	RC-MB219
0 300 890 485	RC-VL613
0 300 890 487	RC-MB208
0 300 890 493	RC-BW232
0 300 890 501	RC-MB209
0 300 890 518	RC-VL613
0 300 890 520	RC-VW206
0 300 890 558	RC-MB211
0 300 890 561	RC-VW215
0 300 890 562	RC-VW216
0 300 890 566	RC-MB215
0 300 890 567	RC-VW239
0 300 890 568	RC-OP204
0 300 890 569	RC-OP466
0 300 890 570	RC-VX402
0 300 890 571	RC-OP402
0 300 890 572	RC-OP402
0 300 890 573	RC-OP408
0 300 890 574	RC-OP408
0 300 890 575	RC-OP427
0 300 890 578	RC-OP455
0 300 890 579	RC-ST405
0 300 890 580	RC-OP418
0 300 890 581	RC-OP1217
0 300 890 583	RC-OP411
0 300 890 584	RC-OP412
0 300 890 585	RC-MB217
0 300 890 597	RC-MB214
0 300 890 598	RC-MB212
0 300 890 607	RC-BW222
0 300 890 608	RC-BW213
0 300 890 610	RC-BW210
0 300 890 612	RC-AD211
0 300 890 626	RC-OP419
0 300 890 627	RC-OP459
0 300 890 635	RC-MB213
0 300 890 641	RC-MB201
0 300 890 642	RC-MB203
0 300 890 665	RC-OP418
0 300 890 672	RC-OP440
0 300 890 707	RC-VW902
0 300 890 708	RC-VW223
0 300 890 709	RC-AD204
0 300 890 716	RC-VW903
0 300 890 717	RC-VW904
0 300 890 719	RC-FD546
0 300 890 722	RC-FT609
0 300 890 724	RC-OP453

BERU	→ NGK
0 300 890 725	RC-OP1208
0 300 890 726	RC-OP432
0 300 890 727	RC-OP444
0 300 890 728	RC-RN646
0 300 890 729	RC-RN655
0 300 890 730	RC-RN627
0 300 890 731	RC-RN623
0 300 890 732	RC-VL609
0 300 890 733	RC-RN629
0 300 890 734	RC-RN648
0 300 890 735	RC-RN637
0 300 890 737	RC-RN632
0 300 890 739	RC-CT402
0 300 890 742	RC-CT402
0 300 890 743	RC-CT611
0 300 890 744	RC-CT405
0 300 890 745	RC-CT611
0 300 890 746	RC-PG612
0 300 890 752	RC-PG604
0 300 890 755	RC-PG608
0 300 890 756	RC-CT601
0 300 890 757	RC-RN639
0 300 890 758	RC-RN639
0 300 890 759	RC-RN1302
0 300 890 760	RC-RN640
0 300 890 761	RC-RN1306
0 300 890 762	RC-PG605
0 300 890 763	RC-CT603
0 300 890 765	RC-LD302
0 300 890 766	RC-LC403
0 300 890 767	RC-ST405
0 300 890 768	RC-ST406
0 300 890 769	RC-DW1206
0 300 890 770	RC-AT404
0 300 890 771	RC-LC610
0 300 890 772	RC-FD824
0 300 890 773	RC-EN1204
0 300 890 775	RC-RV304
0 300 890 776	RC-KA402
0 300 890 777	RC-FT621
0 300 890 778	RC-ET1204
0 300 890 781	RC-FD826
0 300 890 783	RC-FD538
0 300 890 784	RC-FD537
0 300 890 785	RC-FT454
0 300 890 786	RC-FT628
0 300 890 787	RC-FT601
0 300 890 788	RC-CT411
0 300 890 789	RC-PG615
0 300 890 790	RC-CR604
0 300 890 791	RC-PG616
0 300 890 792	RC-PG1301



BERU	→ NGK
0 300 890 793	RC-CR601
0 300 890 795	RC-CT615
0 300 890 796	RC-LC607
0 300 890 797	RC-RN620
0 300 890 798	RC-RN1307
0 300 890 799	RC-VL616
0 300 890 800	RC-RN619
0 300 890 801	RC-AR403
0 300 890 802	RC-AR406
0 300 890 803	RC-AR604
0 300 890 804	RC-AR602
0 300 890 809	RC-FD817
0 300 890 810	RC-FD804
0 300 890 811	RC-FD509
0 300 890 812	RC-SD1201
0 300 890 813	RC-CT615
0 300 890 814	RC-VL607
0 300 890 824	RC-NX71
0 300 890 826	RC-DE23
0 300 890 827	RC-ED1203
0 300 890 828	RC-TE86
0 300 890 829	RC-DE16
0 300 890 830	RC-ED1202
0 300 890 834	RC-DW401
0 300 890 835	RC-DW402
0 300 890 838	RC-HE75
0 300 890 839	RC-HE53
0 300 890 840	RC-HE73
0 300 890 842	RC-RV603
0 300 890 843	RC-HE81
0 300 890 844	RC-RV605
0 300 890 846	RC-HE57
0 300 890 847	RC-EH1202
0 300 890 849	RC-HD408
0 300 890 850	RC-HD407
0 300 890 851	RC-HD409
0 300 890 853	RC-HD404
0 300 890 854	RC-EM1207
0 300 890 856	RC-KA401
0 300 890 858	RC-KA404
0 300 890 859	RC-ZX29
0 300 890 861	RC-EZ1211
0 300 890 862	RC-ZE08
0 300 890 863	RC-ZE07
0 300 890 864	RC-EZ1209
0 300 890 865	RC-EZ1208
0 300 890 866	RC-ZX15
0 300 890 867	RC-ZE06
0 300 890 868	RC-EM1207
0 300 890 869	RC-ZX18
0 300 890 870	RC-ZE21
0 300 890 872	RC-ZE97A

BERU	→ NGK
0 300 890 874	RC-ME79
0 300 890 875	RC-ME74
0 300 890 876	RC-ME96
0 300 890 877	RC-ME64
0 300 890 878	RC-ME109
0 300 890 879	RC-HD409
0 300 890 880	RC-ME78
0 300 890 882	RC-EM1207
0 300 890 883	RC-ME51
0 300 890 884	RC-ME61
0 300 890 886	RC-ME95
0 300 890 889	RC-NE08
0 300 890 890	RC-EN1203
0 300 890 891	RC-NX11
0 300 890 892	RC-NE77A
0 300 890 893	RC-EN1206
0 300 890 894	RC-NX71
0 300 890 895	RC-NE09
0 300 890 896	RC-NX07
0 300 890 899	RC-NX93
0 300 890 900	RC-NX91
0 300 890 901	RC-EZ1202
0 300 890 903	RC-EF1202
0 300 890 906	RC-FX31
0 300 890 907	RC-FE22
0 300 890 909	RC-LC1201
0 300 890 910	RC-ES1204
0 300 890 911	RC-ET1213
0 300 890 912	RC-SE82
0 300 890 913	RC-SE83
0 300 890 915	RC-ES1204
0 300 890 916	RC-SE02
0 300 890 917	RC-TE43
0 300 890 919	RC-TE42
0 300 890 920	RC-ET1208
0 300 890 921	RC-TE24
0 300 890 923	RC-TE41
0 300 890 924	RC-TE43
0 300 890 925	RC-ET1201
0 300 890 927	RC-TX35
0 300 890 929	RC-ET1228
0 300 890 930	RC-ET1219
0 300 890 931	RC-ET1216
0 300 890 932	RC-TE87
0 300 890 933	RC-ET1202
0 300 890 934	RC-TE41
0 300 890 936	RC-ET1214
0 300 890 937	RC-ET1211
0 300 890 938	RC-ET1212
0 300 890 943	RC-TE132
0 300 890 946	RC-TE41
0 300 890 947	RC-TE58



BERU	→ NGK
0 300 890 948	RC-TX71
0 300 890 949	RC-ET1222
0 300 890 951	RC-TX118
0 300 890 952	RC-TE41
0 300 890 958	RC-TX05
0 300 890 960	RC-ET1218
0 300 890 964	RC-TX05
0 300 890 965	RC-TE93
0 300 890 967	RC-FT203
0 300 890 968	RC-FT201
0 300 890 969	RC-AR914
0 300 890 970	RC-AR913
0 300 890 971	RC-AR906
0 300 890 972	RC-AR204
0 300 890 973	RC-AR908
0 300 890 978	RC-FT1204
0 300 890 979	RC-FT428
0 300 890 980	RC-FT414
0 300 890 981	RC-FT442
0 300 890 983	RC-FT1202
0 300 890 987	RC-MB202
0 300 890 989	RC-VW254
0 300 890 990	RC-VW910
0 300 890 991	RC-VW236
0 300 890 992	RC-OP1204
0 300 890 993	RC-OP1213
0 300 890 994	RC-OP434
0 300 890 995	RC-OP1209
0 300 890 996	RC-OP1218
0 300 890 997	RC-OP442
0 300 890 998	RC-OP448
0 300 891 000	RC-TX117
0 300 891 001	RC-ZX16
0 300 891 002	RC-ZE28
0 300 891 004	RC-RV604
0 300 891 005	RC-HE80
0 300 891 006	RC-FT1101
0 300 891 007	RC-AR603
0 300 891 009	RC-FT446
0 300 891 011	RC-FT420
0 300 891 012	RC-FT609
0 300 891 014	RC-FT620
0 300 891 015	RC-FT604
0 300 891 016	RC-FT618
0 300 891 017	RC-FT202
0 300 891 019	RC-LC611
0 300 891 020	RC-LC618
0 300 891 021	RC-LC606
0 300 891 022	RC-LC606
0 300 891 023	RC-LC604
0 300 891 024	RC-FT605
0 300 891 026	RC-FT618

BERU	→ NGK
0 300 891 028	RC-FT603
0 300 891 029	RC-LC1102
0 300 891 030	RC-FT618
0 300 891 032	RC-AR1101
0 300 891 033	RC-AR911
0 300 891 036	RC-AR912
0 300 891 037	RC-AR201
0 300 891 040	RC-RV322
0 300 891 041	RC-LC614
0 300 891 043	RC-LC616
0 300 891 044	RC-CR602
0 300 891 046	RC-ST404
0 300 891 047	RC-FT635
0 300 891 048	RC-FT415
0 300 891 049	RC-PG608
0 300 891 050	RC-PG608
0 300 891 052	RC-FT621
0 300 891 053	RC-FT636
0 300 891 055	RC-FT631
0 300 891 056	RC-LC609
0 300 891 057	RC-LC614
0 300 891 058	RC-FT435
0 300 891 060	RC-FT621
0 300 891 062	RC-LC604
0 300 891 064	RC-FT603
0 300 891 065	RC-FT1206
0 300 891 066	RC-FT601
0 300 891 067	RC-PG608
0 300 891 069	RC-FT608
0 300 891 070	RC-ST404
0 300 891 071	RC-FT638
0 300 891 073	RC-ST403
0 300 891 076	RC-KA1202
0 300 891 077	RC-LC1202
0 300 891 078	RC-LC612
0 300 891 081	RC-HE82
0 300 891 082	RC-EM1202
0 300 891 084	RC-TX117
0 300 891 087	RC-ME111
0 300 891 090	RC-OP447
0 300 891 091	RC-OP1212
0 300 891 092	RC-OP426
0 300 891 093	RC-OP1214
0 300 891 094	RC-RN1203
0 300 891 099	RC-HE71
0 300 891 101	RC-HD1203
0 300 891 103	RC-EZ1215
0 300 891 104	RC-MX1202
0 300 891 105	RC-DW304
0 300 891 110	RC-ET1217
0 300 891 111	RC-TE58
0 300 891 113	RC-RN652



BERU	→ NGK
0 300 891 114	RC-FD1217
0 300 891 115	RC-FD808
0 300 891 116	RC-FD808
0 300 891 117	RC-VW203
0 300 891 118	RC-OP436
0 300 891 119	RC-OP423
0 300 891 120	RC-OP1219
0 300 891 121	RC-OP430
0 300 891 122	RC-OP413
0 300 891 124	RC-OP1208
0 300 891 125	RC-FT1301
0 300 891 127	RC-AD207
0 300 891 128	RC-RN658
0 300 891 129	RC-DW302
0 300 891 130	RC-HD301
0 300 891 131	RC-FD1208
0 300 891 133	RC-OP1215
0 300 891 134	RC-OP1210
0 300 891 135	RC-FT444
0 300 891 137	RC-DW403
0 300 891 140	RC-KA1201
0 300 891 142	RC-DW301
0 300 891 144	RC-HD411
0 300 891 148	RC-VW214
0 300 891 149	RC-VW210
0 300 891 150	RC-ST201
0 300 891 152	RC-OP1206
0 300 891 153	RC-OP440
0 300 891 154	RC-OP450
0 300 891 155	RC-OP1211
0 300 891 156	RC-OP203
0 300 891 157	RC-OP201
0 300 891 158	RC-OP202
0 300 891 159	RC-OP1101
0 300 891 160	RC-OP1203
0 300 891 161	RC-OP1208
0 300 891 162	RC-OP1216
0 300 891 163	RC-RN645
0 300 891 164	RC-CT412
0 300 891 165	RC-RN653
0 300 891 166	RC-ZE37
0 300 891 169	RC-SB605
0 300 891 170	RC-LC1101
0 300 891 171	RC-AD205
0 300 891 172	RC-AD1101
0 300 891 173	RC-FD548
0 300 891 174	RC-AD1101
0 300 891 175	RC-AD201
0 300 891 177	RC-AD206
0 300 891 178	RC-FD544
0 300 891 180	RC-VW225
0 300 891 182	RC-BW205

BERU	→ NGK
0 300 891 183	RC-BW208
0 300 891 184	RC-VW907
0 300 891 185	RC-RN606
0 300 891 186	RC-RN603
0 300 891 187	RC-VW232
0 300 891 188	RC-BW225
0 300 891 189	RC-ST902
0 300 891 190	RC-VL612
0 300 891 191	RC-VL608
0 300 891 192	RC-VL611
0 300 891 193	RC-VL606
0 300 891 194	RC-AD202
0 300 891 195	RC-AD208
0 300 891 196	RC-VW235
0 300 891 197	RC-VW1106
0 300 891 198	RC-AD219
0 300 891 199	RC-VW227
0 300 891 200	RC-SB601
0 300 891 201	RC-FT1203
0 300 891 203	RC-RV1205
0 300 891 204	RC-RV901
0 300 891 206	RC-PG608
0 300 891 209	RC-FT603
0 300 891 211	RC-FD503
0 300 891 214	RC-FD830
0 300 891 215	RC-FD1213
0 300 891 218	RC-AD216
0 300 891 219	RC-AD218
0 300 891 222	RC-VW230
0 300 891 223	RC-AD215
0 300 891 224	RC-VW249
0 300 891 226	RC-FD545
0 300 891 227	RC-CR1202
0 300 891 228	RC-ZE53
0 300 891 229	RC-VW235
0 300 891 230	RC-VW247
0 300 891 231	RC-VL605
0 300 891 232	RC-RN608
0 300 891 233	RC-VW244
0 300 891 235	RC-SB408
0 300 891 236	RC-BW218
0 300 891 245	RC-EF1204
0 300 891 246	RC-FX54
0 300 891 251	RC-RN1304
0 300 891 253	RC-FD1203
0 300 891 254	RC-AR601
0 300 891 255	RC-ST901
0 300 891 256	RC-PG602
0 300 891 260	RC-VW201
0 300 891 262	RC-VL1301
0 300 891 264	RC-FD533
0 300 891 272	RC-HD1205



BERU	→ NGK
0 300 891 301	RC-OP1201
0 300 891 304	RC-ET1221
0 300 891 305	RC-ET1229
0 300 891 308	RC-TX99A
0 300 891 316	RC-TE66
0 300 891 327	RC-CR1203
0 300 891 338	RC-BW235
0 300 891 340	RC-CR308
0 300 891 348	RC-AR903
0 300 891 360	RC-ZE21
0 300 891 365	RC-LC901
0 300 891 367	RC-AD1102
0 300 891 370	RC-ET1301
0 300 891 371	RC-ME106A
0 300 891 372	RC-ME59
0 300 891 373	RC-ZE23
0 300 891 375	RC-ZE32B
0 300 891 376	RC-EM1203
0 300 891 378	RC-NX89
0 300 891 380	RC-MB225
0 300 891 382	RC-OP421
0 300 891 384	RC-OP414
0 300 891 385	RC-FE43
0 300 891 388	RC-RN649
0 300 891 390	RC-RV413
0 300 891 391	RC-RN620
0 300 891 392	RC-CT605
0 300 891 395	RC-RN620
0 300 891 397	RC-RV415
0 300 891 402	RC-BW223
0 300 891 409	RC-CR305
0 300 891 412	RC-MB222
0 300 891 442	RC-MB223
0 300 891 449	RC-MB202
0 300 891 450	RC-MB220
0 300 891 475	RC-FD1205
0 300 891 477	RC-FT1208
0 300 891 478	RC-VW210
0 300 891 479	RC-MB1104
0 300 891 480	RC-RV1301
0 300 891 488	RC-MB1103
0 300 891 496	RC-VW1107
0 300 891 497	RC-EF1201
0 300 891 503	RC-RV308
0 300 891 504	RC-RV307
0 300 891 505	RC-RV301
0 300 891 509	RC-OP440
0 300 891 519	RC-HD1202
0 300 891 520	RC-HD407
0 300 891 528	RC-FX51
0 300 891 529	RC-SE13
0 300 891 530	RC-KA1204

BERU	→ NGK
0 300 891 539	RC-FD1207
0 300 891 540	RC-FD1207
0 300 891 542	RC-FD1210
0 300 891 543	RC-FD1209
0 300 891 545	RC-CR1302
0 300 891 546	RC-RN1202
0 300 891 549	RC-FD807
0 300 891 556	RC-MB1106
0 300 891 557	RC-VW246
0 300 891 572	RC-VW1105
0 300 891 597	RC-FD1216
0 300 891 598	RC-FT1209
0 300 891 602	RC-RN1204
0 300 891 604	RC-RN1311
0 300 891 608	RC-DW1202
0 300 891 609	RC-GM1203
0 300 891 612	RC-RN1308
0 300 891 625	RC-VL1305
0 300 891 628	RC-FD807
0 300 891 629	RC-VW1110
0 300 891 633	RC-FD1210
0 300 891 634	RC-FD1210
0 302 100 006	450 050
0 302 100 008	450 100
0 302 100 009	451 030
0 302 100 010	451 050
0 302 100 028	419 050
0 302 100 031	423 040
0 302 100 032	423 050
0 302 100 033	423 060
0 302 100 034	423 070
0 302 100 039	RC-FD537
0 302 100 040	577 061
0 302 100 041	577 080
0 302 100 059	766 030
0 302 100 060	766 050
0 302 100 088	433 060
0 302 100 094	479 040
0 302 100 095	479 070
0 302 100 096	469 040
0 302 100 097	469 060
0 302 100 098	470 025
0 302 100 101	470 040
0 302 100 102	470 050
0 302 100 103	470 060
0 302 100 104	470 070
0 302 100 111	RC-HE73
0 302 100 141	513 020
0 302 100 142	513 035
0 302 100 143	513 050
0 302 100 144	513 050
0 302 100 146	RC-OP1204



BERU	→ NGK
0 302 100 149	481 030
0 302 100 150	481 040
0 302 100 151	481 050
0 302 100 152	481 060
0 302 100 153	481 070
0 302 100 156	RC-OP1101
0 302 100 157	RC-OP1101
0 302 100 185	516 080
0 302 100 186	516 080
0 302 100 187	516 100
0 302 100 188	516 100
0 302 100 226	418 090
0 302 100 237	RC-OP1209
0 302 100 248	419 070
0 302 100 258	479 040
0 302 100 259	479 070
0 302 100 262	470 025
0 302 100 264	470 040
0 302 100 266	470 050
0 302 100 267	470 060
0 302 100 272	481 030
0 302 100 274	481 040
0 302 100 276	481 060
0 302 100 277	481 070
0 302 100 280	RC-OP1101
0 302 100 281	RC-OP1101
0 302 100 289	RC-ZX49
0 302 100 290	RC-ZX49
0 302 100 327	643 040
0 302 100 328	643 050
0 302 100 329	643 060
0 302 100 338	RC-ET1214
0 302 100 340	RC-ET1214
0 302 100 341	RC-ET1214
0 302 100 345	RC-ZE53
0 302 100 389	407 020
0 302 100 390	407 040
0 302 100 391	407 050
0 302 100 392	407 060
0 302 100 407	471 040
0 302 100 409	471 030
0 302 100 410	471 050
0 302 101 030	410 030
0 302 101 040	410 040
0 302 101 050	410 050
0 302 101 060	410 060
0 302 101 070	410 070
0 302 101 080	410 080
0 302 101 090	410 090
0 302 103 030	414 030
0 302 103 040	414 040
0 302 103 050	414 050

BERU	→ NGK
0 302 103 060	414 060
0 302 103 070	414 070
0 302 104 030	411 030
0 302 104 040	411 040
0 302 104 050	411 050
0 302 104 060	411 060
0 302 104 070	411 070
0 302 104 080	411 080
0 302 104 090	411 090
0 302 105 028	417 030
0 302 111 100	418 075
0 302 111 102	418 090
0 302 111 103	419 050
0 302 111 105	419 070
0 302 112 050	424 050
0 302 112 060	424 060
0 302 113 105	411 100
B 100 B	RC-BW223
B 102 A	226 035
B 102 B	226 035
B 102 C	226 055
B 102 D	226 055
B 103 B	RC-BW233
B 104 C	221 120
B 104 D	221 130
M 107B	RC-MB211
M 118A	294 050
M 118B	294 055
R 10-030	414 030
R 1-060	410 060
R 11-070	411 070
R 113-050	419 050
R 116-040	423 040
R 117-050	423 050
R 118-060	423 060
R 119-070	423 070
R 12-050	411 050
R 123-085 S	419 070
R 124-060	RC-FD537
R 125-065	577 061
R 126-083	577 080
R 13-080	411 080
R 14-030	411 030
R 144-040	766 030
R 145-055	766 050
R 153-053	433 060
R 159-032	479 040
R 159-032 S	479 040
R 160-055	479 070
R 160-055 S	479 070
R 16-040	411 040
R 161-040	469 040



BERU	→ NGK
R 162-060	469 060
R 163-020	470 025
R 163-020 S	470 025
R 165-035 S	470 040
R 166-045	470 040
R 167-055	470 050
R 167-055 S	470 050
R 168-060	470 060
R 168-060 S	470 060
R 169-070	470 070
R 176-042	RC-HE73
R 18-060	414 060
R 20-105	411 100
R 2-040	414 040
R 206-024	513 020
R 207-038	513 035
R 208-046	513 050
R 209-052	513 050
R 211-040	RC-OP1204
R 214-027	481 030
R 214-027 S	481 030
R 215-040	481 040
R 215-040 S	481 040
R 216-052	481 050
R 217-062	481 060
R 217-062 S	481 060
R 218-070	481 070
R 218-070 S	481 070
R 221-050	RC-OP1101
R 221-050 S	RC-OP1101
R 222-060	RC-OP1101
R 222-060 S	RC-OP1101
R 24-070	414 070
R 250-075	516 080
R 251-085	516 080
R 252-095	516 100
R 253-100	516 100
R 28-090	411 090
R 29-090	410 090
R 296-065	RC-ZX49
R 297-045	RC-ZX49
R 3-050	410 050
R 334-045	643 040
R 335-050	643 050
R 336-060	643 060
R 341-035	RC-ET1214
R 343-059	RC-ET1214
R 344-064	RC-ET1214
R 348-040	RC-ZE53
R 392-011	407 020
R 393-025	407 040
R 394-034	407 050

BERU	→ NGK
R 395-043	407 060
R 4-040	410 040
R 409-037	471 040
R 411-022	471 030
R 412-047	471 050
R 42-060	424 060
R 5-050	414 050
R 53-050	424 050
R 55-028	417 030
R 6-070	410 070
R 7-030	410 030
R 80-076	418 075
R 8-060	411 060
R 82-086	418 090
R 82-086 S	418 090
R 83-050	419 050
R 85-070	419 070
R 9-080	410 080
R 91-050	450 050
R 93-100	450 100
R 94-030	451 030
R 95-050	451 050
R 95-050 S	RC-OP1209
VA 115A	210 030
VA 115B	210 040
VA 115C	210 050
VA 115D	210 060
VA 116A	211 040
VA 116B	211 050
VA 116C	211 060
VA 116D	211 070
VA 116E	211 080
VA 117A	214 040
VA 117B	214 060
VA 118B	215 040
VA 118C	215 060
VA 119C	293 020
VA 120D	296 045
VA 120E	296 045
VA 121A	131 050
VA 121B	131 040
VA 121C	131 030
VA 123A	295 030
VA 123B	295 040
VA 123C	295 055
VA 125A	236 060
VA 125B	236 070
VA 125C	236 085
VA 127B	293 040
VA 138A	247 030
ZE 566	RC-PS1102
ZE 575	RC-BW231



BERU	→ NGK
ZE 590	RC-PS1103
ZE 719	RC-BW230
ZE 721	RC-BW223
ZE 727	RC-BW233
ZE 738	RC-BW232
ZE 755	RC-BW223
ZE 757	RC-BW218
ZE 765	RC-AD204
ZEF 1000	RC-TX117
ZEF 1001	RC-ZX16
ZEF 1002	RC-ZE28
ZEF 1004	RC-RV604
ZEF 1005	RC-HE80
ZEF 1006	RC-FT1101
ZEF 1007	RC-AR603
ZEF 1009	RC-FT446
ZEF 1011	RC-FT420
ZEF 1012	RC-FT609
ZEF 1014	RC-FT620
ZEF 1015	RC-FT604
ZEF 1016	RC-FT618
ZEF 1017	RC-FT202
ZEF 1019	RC-LC611
ZEF 1020	RC-LC618
ZEF 1021	RC-LC606
ZEF 1022	RC-LC606
ZEF 1023	RC-LC604
ZEF 1024	RC-FT605
ZEF 1026	RC-FT618
ZEF 1028	RC-FT603
ZEF 1029	RC-LC1102
ZEF 1030	RC-FT618
ZEF 1032	RC-AR1101
ZEF 1033	RC-AR911
ZEF 1036	RC-AR912
ZEF 1037	RC-AR201
ZEF 1040	RC-RV322
ZEF 1041	RC-LC614
ZEF 1043	RC-LC616
ZEF 1044	RC-CR602
ZEF 1046	RC-ST404
ZEF 1047	RC-FT635
ZEF 1048	RC-FT415
ZEF 1049	RC-PG608
ZEF 1050	RC-PG608
ZEF 1052	RC-FT621
ZEF 1053	RC-FT636
ZEF 1055	RC-FT631
ZEF 1056	RC-LC609
ZEF 1057	RC-LC614
ZEF 1058	RC-FT435
ZEF 1060	RC-FT621

BERU	→ NGK
ZEF 1062	RC-LC604
ZEF 1064	RC-FT603
ZEF 1065	RC-FT1206
ZEF 1066	RC-FT601
ZEF 1067	RC-PG608
ZEF 1069	RC-FT608
ZEF 1070	RC-ST404
ZEF 1071	RC-FT638
ZEF 1073	RC-ST403
ZEF 1076	RC-KA1202
ZEF 1077	RC-LC1202
ZEF 1078	RC-LC612
ZEF 1081	RC-HE82
ZEF 1082	RC-EM1202
ZEF 1084	RC-TX117
ZEF 1087	RC-ME111
ZEF 1090	RC-OP447
ZEF 1091	RC-OP1212
ZEF 1092	RC-OP426
ZEF 1093	RC-OP1214
ZEF 1094	RC-RN1203
ZEF 1099	RC-HE71
ZEF 1101	RC-HD1203
ZEF 1103	RC-EZ1215
ZEF 1104	RC-MX1202
ZEF 1105	RC-DW304
ZEF 1110	RC-ET1217
ZEF 1111	RC-TE58
ZEF 1113	RC-RN652
ZEF 1114	RC-FD1217
ZEF 1115	RC-FD808
ZEF 1116	RC-FD808
ZEF 1117	RC-VW203
ZEF 1118	RC-OP436
ZEF 1119	RC-OP423
ZEF 1120	RC-OP1219
ZEF 1121	RC-OP430
ZEF 1122	RC-OP413
ZEF 1124	RC-OP1208
ZEF 1125	RC-FT1301
ZEF 1127	RC-AD207
ZEF 1128	RC-RN658
ZEF 1129	RC-DW302
ZEF 1130	RC-HD301
ZEF 1131	RC-FD1208
ZEF 1133	RC-OP1215
ZEF 1134	RC-OP1210
ZEF 1135	RC-FT444
ZEF 1137	RC-DW403
ZEF 1140	RC-KA1201
ZEF 1142	RC-DW301
ZEF 1144	RC-HD411



BERU	→ NGK
ZEF 1148	RC-VW214
ZEF 1149	RC-VW210
ZEF 1150	RC-ST201
ZEF 1152	RC-OP1206
ZEF 1153	RC-OP440
ZEF 1154	RC-OP450
ZEF 1155	RC-OP1211
ZEF 1156	RC-OP203
ZEF 1157	RC-OP201
ZEF 1158	RC-OP202
ZEF 1159	RC-OP1101
ZEF 1160	RC-OP1203
ZEF 1161	RC-OP1208
ZEF 1162	RC-OP1216
ZEF 1163	RC-RN645
ZEF 1164	RC-CT412
ZEF 1165	RC-RN653
ZEF 1166	RC-ZE37
ZEF 1169	RC-SB605
ZEF 1170	RC-LC1101
ZEF 1171	RC-AD205
ZEF 1172	RC-AD1101
ZEF 1173	RC-FD548
ZEF 1174	RC-AD1101
ZEF 1175	RC-AD201
ZEF 1177	RC-AD206
ZEF 1178	RC-FD544
ZEF 1180	RC-VW225
ZEF 1182	RC-BW205
ZEF 1183	RC-BW208
ZEF 1184	RC-VW907
ZEF 1185	RC-RN606
ZEF 1186	RC-RN603
ZEF 1187	RC-VW232
ZEF 1188	RC-BW225
ZEF 1189	RC-ST902
ZEF 1190	RC-VL612
ZEF 1191	RC-VL608
ZEF 1192	RC-VL611
ZEF 1193	RC-VL606
ZEF 1194	RC-AD202
ZEF 1195	RC-AD208
ZEF 1196	RC-VW235
ZEF 1197	RC-VW1106
ZEF 1198	RC-AD219
ZEF 1199	RC-VW227
ZEF 1200	RC-SB601
ZEF 1201	RC-FT1203
ZEF 1203	RC-RV1205
ZEF 1204	RC-RV901
ZEF 1206	RC-PG608
ZEF 1209	RC-FT603

BERU	→ NGK
ZEF 1211	RC-FD503
ZEF 1214	RC-FD830
ZEF 1215	RC-FD1213
ZEF 1218	RC-AD216
ZEF 1219	RC-AD218
ZEF 1222	RC-VW230
ZEF 1223	RC-AD215
ZEF 1224	RC-VW249
ZEF 1226	RC-FD545
ZEF 1227	RC-CR1202
ZEF 1228	RC-ZE53
ZEF 1229	RC-VW235
ZEF 1230	RC-VW247
ZEF 1231	RC-VL605
ZEF 1232	RC-RN608
ZEF 1233	RC-VW244
ZEF 1235	RC-SB408
ZEF 1236	RC-BW218
ZEF 1245	RC-EF1204
ZEF 1246	RC-FX54
ZEF 1251	RC-RN1304
ZEF 1253	RC-FD1203
ZEF 1254	RC-AR601
ZEF 1255	RC-ST901
ZEF 1256	RC-PG602
ZEF 1260	RC-VW201
ZEF 1262	RC-VL1301
ZEF 1264	RC-FD533
ZEF 1272	RC-HD1205
ZEF 1301	RC-OP1201
ZEF 1304	RC-ET1221
ZEF 1305	RC-ET1229
ZEF 1308	RC-TX99A
ZEF 1316	RC-TE66
ZEF 1327	RC-CR1203
ZEF 1338	RC-BW235
ZEF 1340	RC-CR308
ZEF 1348	RC-AR903
ZEF 1360	RC-ZE21
ZEF 1365	RC-LC901
ZEF 1367	RC-AD1102
ZEF 1370	RC-ET1301
ZEF 1371	RC-ME106A
ZEF 1372	RC-ME59
ZEF 1373	RC-ZE23
ZEF 1375	RC-ZE32B
ZEF 1376	RC-EM1203
ZEF 1378	RC-NX89
ZEF 1380	RC-MB225
ZEF 1382	RC-OP421
ZEF 1384	RC-OP414
ZEF 1385	RC-FE43



BERU	→ NGK
ZEF 1388	RC-RN649
ZEF 1390	RC-RV413
ZEF 1391	RC-RN620
ZEF 1392	RC-CT605
ZEF 1395	RC-RN620
ZEF 1397	RC-RV415
ZEF 1402	RC-BW223
ZEF 1409	RC-CR305
ZEF 1412	RC-MB222
ZEF 1442	RC-MB223
ZEF 1449	RC-MB202
ZEF 1450	RC-MB220
ZEF 1475	RC-FD1205
ZEF 1477	RC-FT1208
ZEF 1478	RC-VW210
ZEF 1479	RC-MB1104
ZEF 1480	RC-RV1301
ZEF 1488	RC-MB1103
ZEF 1496	RC-VW1107
ZEF 1497	RC-EF1201
ZEF 1503	RC-RV308
ZEF 1504	RC-RV307
ZEF 1505	RC-RV301
ZEF 1509	RC-OP440
ZEF 1519	RC-HD1202
ZEF 1520	RC-HD407
ZEF 1528	RC-FX51
ZEF 1529	RC-SE13
ZEF 1530	RC-KA1204
ZEF 1539	RC-FD1207
ZEF 1540	RC-FD1207
ZEF 1542	RC-FD1210
ZEF 1543	RC-FD1209
ZEF 1545	RC-CR1302
ZEF 1546	RC-RN1202
ZEF 1549	RC-FD807
ZEF 1556	RC-MB1106
ZEF 1557	RC-VW246
ZEF 1572	RC-VW1105
ZEF 1597	RC-FD1216
ZEF 1598	RC-FT1209
ZEF 1602	RC-RN1204
ZEF 1604	RC-RN1311
ZEF 1608	RC-DW1202
ZEF 1609	RC-GM1203
ZEF 1612	RC-RN1308
ZEF 1625	RC-VL1305
ZEF 1628	RC-FD807
ZEF 1629	RC-VW1110
ZEF 1633	RC-FD1210
ZEF 1634	RC-FD1210
ZEF 298	RC-VW223

BERU	→ NGK
ZEF 304	RC-VW217
ZEF 309	RC-PS1106
ZEF 404	RC-AD212
ZEF 405	RC-BW1201
ZEF 408	RC-PS1101
ZEF 425	RC-BW1101
ZEF 432	RC-VW1102
ZEF 435	RC-MB218
ZEF 437	RC-MB206
ZEF 463	RC-MB216
ZEF 464	RC-AD1103
ZEF 466	RC-MB1105
ZEF 467	RC-BW231
ZEF 470	RC-MB208
ZEF 473	RC-MB219
ZEF 485	RC-VL613
ZEF 487	RC-MB208
ZEF 493	RC-BW232
ZEF 501	RC-MB209
ZEF 518	RC-VL613
ZEF 520	RC-VW206
ZEF 558	RC-MB211
ZEF 561	RC-VW215
ZEF 562	RC-VW216
ZEF 566	RC-MB215
ZEF 567	RC-VW239
ZEF 568	RC-OP204
ZEF 569	RC-OP466
ZEF 570	RC-VX402
ZEF 571	RC-OP402
ZEF 572	RC-OP402
ZEF 573	RC-OP408
ZEF 574	RC-OP408
ZEF 575	RC-OP427
ZEF 578	RC-OP455
ZEF 579	RC-ST405
ZEF 580	RC-OP418
ZEF 581	RC-OP1217
ZEF 583	RC-OP411
ZEF 584	RC-OP412
ZEF 585	RC-MB217
ZEF 597	RC-MB214
ZEF 598	RC-MB212
ZEF 607	RC-BW222
ZEF 608	RC-BW213
ZEF 610	RC-BW210
ZEF 612	RC-AD211
ZEF 626	RC-OP419
ZEF 627	RC-OP459
ZEF 635	RC-MB213
ZEF 641	RC-MB201
ZEF 642	RC-MB203



BERU	→ NGK
ZEF 665	RC-OP418
ZEF 672	RC-OP440
ZEF 707	RC-VW902
ZEF 716	RC-VW903
ZEF 717	RC-VW904
ZEF 719	RC-FD546
ZEF 722	RC-FT609
ZEF 724	RC-OP453
ZEF 725	RC-OP1208
ZEF 726	RC-OP432
ZEF 727	RC-OP444
ZEF 728	RC-RN646
ZEF 729	RC-RN655
ZEF 730	RC-RN627
ZEF 731	RC-RN623
ZEF 732	RC-VL609
ZEF 733	RC-RN629
ZEF 734	RC-RN648
ZEF 735	RC-RN637
ZEF 737	RC-RN632
ZEF 739	RC-CT402
ZEF 742	RC-CT402
ZEF 743	RC-CT611
ZEF 744	RC-CT405
ZEF 745	RC-CT611
ZEF 746	RC-PG612
ZEF 752	RC-PG604
ZEF 755	RC-PG608
ZEF 756	RC-CT601
ZEF 757	RC-RN639
ZEF 758	RC-RN639
ZEF 759	RC-RN1302
ZEF 760	RC-RN640
ZEF 761	RC-RN1306
ZEF 762	RC-PG605
ZEF 763	RC-CT603
ZEF 765	RC-LD302
ZEF 766	RC-LC403
ZEF 767	RC-ST405
ZEF 768	RC-ST406
ZEF 769	RC-DW1206
ZEF 770	RC-AT404
ZEF 771	RC-LC610
ZEF 772	RC-FD824
ZEF 773	RC-EN1204
ZEF 775	RC-RV304
ZEF 776	RC-KA402
ZEF 777	RC-FT621
ZEF 778	RC-ET1204
ZEF 781	RC-FD826
ZEF 783	RC-FD538
ZEF 784	RC-FD537

BERU	→ NGK
ZEF 785	RC-FT454
ZEF 786	RC-FT628
ZEF 787	RC-FT601
ZEF 788	RC-CT411
ZEF 789	RC-PG615
ZEF 790	RC-CR604
ZEF 791	RC-PG616
ZEF 792	RC-PG1301
ZEF 793	RC-CR601
ZEF 795	RC-CT615
ZEF 796	RC-LC607
ZEF 797	RC-RN620
ZEF 798	RC-RN1307
ZEF 799	RC-VL616
ZEF 800	RC-RN619
ZEF 801	RC-AR403
ZEF 802	RC-AR406
ZEF 803	RC-AR604
ZEF 804	RC-AR602
ZEF 809	RC-FD817
ZEF 810	RC-FD804
ZEF 811	RC-FD509
ZEF 812	RC-SD1201
ZEF 813	RC-CT615
ZEF 814	RC-VL607
ZEF 824	RC-NX71
ZEF 826	RC-DE23
ZEF 827	RC-ED1203
ZEF 828	RC-TE86
ZEF 829	RC-DE16
ZEF 830	RC-ED1202
ZEF 834	RC-DW401
ZEF 835	RC-DW402
ZEF 838	RC-HE75
ZEF 839	RC-HE53
ZEF 840	RC-HE73
ZEF 842	RC-RV603
ZEF 843	RC-HE81
ZEF 844	RC-RV605
ZEF 846	RC-HE57
ZEF 847	RC-EH1202
ZEF 849	RC-HD408
ZEF 850	RC-HD407
ZEF 851	RC-HD409
ZEF 853	RC-HD404
ZEF 854	RC-EM1207
ZEF 856	RC-KA401
ZEF 858	RC-KA404
ZEF 859	RC-ZX29
ZEF 861	RC-EZ1211
ZEF 862	RC-ZE08
ZEF 863	RC-ZE07



BMW	→ NGK
1 705 715	RC-BW233
1 705 716	RC-BW233
1 706 005	RC-BW233
1 709 206	RC-BW235
1 710 591	RC-BW232
1 710 607	221 095
1 710 610	221 105
1 710 622	221 120
1 710 625	221 130
1 715 356	RC-BW235
1 716 939	RC-BW223
1 717 646	RC-BW222
1 719 986	RC-BW223
1 719 989	232 080
1 720 529	RC-BW218
1 727 100	RC-BW225
1 727 686	RC-BW222
1 727 855	RC-BW210
1 727 928	RC-BW213
12 12 1 247 361	RC-BW208
12 12 1 247 362	226 026
12 12 1 247 363	226 035
12 12 1 247 364	226 035
12 12 1 247 365	226 035
12 12 1 247 521	RC-BW205
12 12 1 270 550	RC-BW233
12 12 1 360 603	RC-BW1201
12 12 1 705 697	RC-BW231
12 12 1 705 714	RC-BW230
12 12 1 705 715	RC-BW233
12 12 1 705 716	RC-BW233
12 12 1 706 005	RC-BW233
12 12 1 709 206	RC-BW235
12 12 1 710 591	RC-BW232
12 12 1 710 607	221 095
12 12 1 710 610	221 105
12 12 1 710 622	221 120
12 12 1 710 625	221 130
12 12 1 715 356	RC-BW235
12 12 1 716 939	RC-BW223
12 12 1 717 646	RC-BW222
12 12 1 719 986	RC-BW223
12 12 1 719 989	232 080
12 12 1 720 529	RC-BW218
12 12 1 727 100	RC-BW225
12 12 1 727 686	RC-BW222
12 12 1 727 855	RC-BW210
12 12 1 727 928	RC-BW213
12 12 7 513 032-035	RC-RV1301
7 513 032-035	RC-RV1301

BOSCH	→ NGK
9 863 560 020	411 040
0 356 912 857	RC-AD1102
0 356 912 901	226 035
0 356 912 945	210 040
0 986 356 000	411 030
0 986 356 002	411 040
0 986 356 004	411 050
0 986 356 006	411 060
0 986 356 008	411 070
0 986 356 010	411 080
0 986 356 012	411 090
0 986 356 013	411 100
0 986 356 017	410 030
0 986 356 019	410 040
0 986 356 021	410 050
0 986 356 023	410 060
0 986 356 025	410 070
0 986 356 027	410 080
0 986 356 029	410 090
0 986 356 038	414 030
0 986 356 040	414 040
0 986 356 042	414 050
0 986 356 044	414 060
0 986 356 046	414 070
0 986 356 059	410 060
0 986 356 060	410 080
0 986 356 061	424 040
0 986 356 062	424 050
0 986 356 063	424 060
0 986 356 081	418 075
0 986 356 084	419 070
0 986 356 085	419 050
0 986 356 089	451 030
0 986 356 090	451 050
0 986 356 338	RC-VW215
0 986 356 339	RC-VW904
0 986 356 340	RC-AD216
0 986 356 341	RC-VW907
0 986 356 343	RC-VW903
0 986 356 351	RC-MB203
0 986 356 352	RC-MB220
0 986 356 355	RC-VW1101
0 986 356 359	RC-VW254
0 986 356 362	RC-BW218
0 986 356 376	RC-PS1103
0 986 356 377	RC-PS1102
0 986 356 700	RC-FD538
0 986 356 702	RC-NX71
0 986 356 703	RC-EN1203
0 986 356 705	RC-NE09
0 986 356 706	RC-FD1201
0 986 356 707	RC-RV322



BOSCH	→ NGK
0 986 356 709	RC-FT618
0 986 356 712	RC-LC609
0 986 356 714	RC-CR304
0 986 356 717	RC-FT604
0 986 356 718	RC-LC604
0 986 356 719	RC-MX401
0 986 356 720	RC-SB601
0 986 356 721	RC-HE64
0 986 356 722	RC-OP426
0 986 356 723	RC-OP455
0 986 356 724	RC-FD521
0 986 356 725	RC-CT411
0 986 356 726	RC-LD301
0 986 356 731	RC-RV415
0 986 356 732	RC-ES1202
0 986 356 735	RC-KA401
0 986 356 736	RC-LC614
0 986 356 737	RC-FT636
0 986 356 738	RC-FT628
0 986 356 739	RC-DW1201
0 986 356 741	RC-OP402
0 986 356 743	RC-RN629
0 986 356 744	RC-VL616
0 986 356 746	RC-OP423
0 986 356 747	RC-OP419
0 986 356 748	RC-RV413
0 986 356 749	RC-PG616
0 986 356 750	RC-SD401
0 986 356 751	RC-PG602
0 986 356 752	RC-FT620
0 986 356 754	RC-FT601
0 986 356 758	RC-ZX16
0 986 356 759	RC-RV406
0 986 356 761	RC-FT435
0 986 356 762	RC-SE83
0 986 356 763	RC-RV318
0 986 356 767	RC-CR601
0 986 356 768	RC-LD302
0 986 356 772	RC-RV304
0 986 356 773	RC-VL1301
0 986 356 774	RC-FD509
0 986 356 780	RC-RN627
0 986 356 781	RC-CT602
0 986 356 782	RC-HD409
0 986 356 783	RC-FD820
0 986 356 785	RC-ST404
0 986 356 786	RC-ST403
0 986 356 788	RC-JG1201
0 986 356 791	RC-FT603
0 986 356 792	RC-FT634
0 986 356 794	RC-CR604
0 986 356 795	RC-PG608

BOSCH	→ NGK
0 986 356 796	RC-OP447
0 986 356 797	RC-AT404
0 986 356 798	RC-RN620
0 986 356 800	RC-OP411
0 986 356 801	RC-OP418
0 986 356 803	RC-CT605
0 986 356 805	RC-FD546
0 986 356 806	RC-RV307
0 986 356 807	RC-NX93
0 986 356 811	RC-FT446
0 986 356 812	RC-ZE08
0 986 356 813	RC-HD408
0 986 356 814	RC-OP414
0 986 356 815	RC-EZ1208
0 986 356 816	RC-FT417
0 986 356 818	RC-FT1201
0 986 356 819	RC-RV323
0 986 356 820	RC-PG603
0 986 356 821	RC-NE08
0 986 356 823	RC-AR604
0 986 356 824	RC-VL607
0 986 356 825	RC-CT613
0 986 356 826	RC-OP427
0 986 356 827	RC-CT402
0 986 356 828	RC-ST405
0 986 356 830	RC-CT615
0 986 356 831	RC-RV309
0 986 356 833	RC-FD1203
0 986 356 834	RC-CR309
0 986 356 835	RC-AR610
0 986 356 836	RC-FT608
0 986 356 838	RC-HD301
0 986 356 839	RC-ZE98
0 986 356 840	RC-LC617
0 986 356 843	RC-HD1201
0 986 356 844	RC-AT405
0 986 356 846	RC-FT609
0 986 356 848	RC-CT603
0 986 356 850	RC-OP412
0 986 356 851	RC-CT611
0 986 356 853	RC-FT621
0 986 356 854	RC-PG617
0 986 356 856	RC-AR602
0 986 356 857	RC-FT635
0 986 356 858	RC-FD530
0 986 356 860	RC-FD544
0 986 356 861	RC-LC611
0 986 356 862	RC-VX415
0 986 356 863	RC-PG615
0 986 356 864	RC-OP421
0 986 356 865	RC-AT402
0 986 356 866	RC-VL611



BOSCH	→ NGK
0 986 356 867	RC-RV604
0 986 356 868	RC-FD825
0 986 356 869	RC-FT605
0 986 356 870	RC-FD536
0 986 356 874	RC-FT631
0 986 356 875	RC-FT638
0 986 356 878	RC-AR907
0 986 356 879	RC-FD830
0 986 356 880	RC-FD804
0 986 356 881	RC-HD409
0 986 356 882	RC-FT420
0 986 356 883	RC-RN655
0 986 356 886	RC-OP408
0 986 356 887	RC-FD537
0 986 356 888	RC-RN637
0 986 356 889	RC-CT601
0 986 356 890	RC-VL608
0 986 356 891	RC-RV605
0 986 356 892	RC-LC201
0 986 356 897	RC-KA402
0 986 356 898	RC-HD1202
0 986 356 929	RC-ET1210
0 986 356 931	RC-TE24
0 986 356 934	RC-ET1201
0 986 356 937	RC-ET1213
0 986 356 941	RC-TE83
0 986 356 947	RC-TX08
0 986 356 948	RC-TX02
0 986 356 949	RC-ET1207
0 986 356 953	RC-ET1208
0 986 356 954	RC-TE87
0 986 356 955	RC-ET1203
0 986 356 957	RC-TE41
0 986 356 959	RC-FD1204
0 986 356 963	RC-EH1201
0 986 356 964	RC-RN653
0 986 356 965	RC-RN653
0 986 356 966	RC-ZE31
0 986 356 967	RC-RN606
0 986 356 980	RC-DW301
0 986 356 982	RC-KA1203
0 986 356 984	RC-ST406
0 986 356 987	RC-DW1203
0 986 356 988	RC-DW304
0 986 356 991	RC-HD1204
0 986 357 010	RC-ST601
0 986 357 011	RC-OP459
0 986 357 012	RC-FD803
0 986 357 013	RC-VL612
0 986 357 014	RC-AR403
0 986 357 025	RC-AD1101
0 986 357 063	RC-OP463

BOSCH	→ NGK
0 986 357 068	RC-SD1201
0 986 357 075	RC-AR603
0 986 357 076	RC-LC1301
0 986 357 077	RC-AR406
0 986 357 080	RC-FT442
0 986 357 081	RC-FT428
0 986 357 082	RC-FT431
0 986 357 084	RC-FT615
0 986 357 085	RC-FT414
0 986 357 086	RC-OP413
0 986 357 088	RC-LC403
0 986 357 090	RC-FD545
0 986 357 091	RC-JG1202
0 986 357 094	RC-RV404
0 986 357 095	RC-RV401
0 986 357 096	RC-FT607
0 986 357 098	RC-CR602
0 986 357 100	RC-RN409
0 986 357 101	RC-RN648
0 986 357 103	RC-AR414
0 986 357 104	RC-RV1207
0 986 357 106	RC-MX1201
0 986 357 110	RC-JG1203
0 986 357 113	RC-LC606
0 986 357 114	RC-VX402
0 986 357 116	RC-PG406
0 986 357 118	RC-CR306
0 986 357 119	RC-FT624
0 986 357 120	RC-CT412
0 986 357 121	RC-PG618
0 986 357 122	RC-ME54
0 986 357 123	RC-PG1301
0 986 357 124	RC-OP434
0 986 357 125	RC-OP430
0 986 357 126	RC-OP1208
0 986 357 127	RC-OP436
0 986 357 128	RC-PG601
0 986 357 129	RC-FD824
0 986 357 130	RC-LC615
0 986 357 133	RC-FT415
0 986 357 135	RC-PG605
0 986 357 137	RC-RN639
0 986 357 140	RC-FD533
0 986 357 141	RC-FD808
0 986 357 142	RC-HD411
0 986 357 143	RC-OP450
0 986 357 144	RC-OP1209
0 986 357 145	RC-FD532
0 986 357 146	RC-LC610
0 986 357 148	RC-OP432
0 986 357 149	RC-ZE37
0 986 357 150	RC-HE82



BOSCH	→ NGK
0 986 357 151	RC-ME64
0 986 357 152	RC-RV412
0 986 357 153	RC-RV414
0 986 357 154	RC-RV1202
0 986 357 155	RC-RV305
0 986 357 156	RC-OP453
0 986 357 157	RC-EM1203
0 986 357 158	RC-RN603
0 986 357 159	RC-ME109
0 986 357 160	RC-RV1203
0 986 357 161	RC-SB605
0 986 357 162	RC-SB408
0 986 357 164	RC-JG1204
0 986 357 165	RC-EZ1210
0 986 357 166	RC-VL605
0 986 357 167	RC-OP1201
0 986 357 168	RC-DE11
0 986 357 170	RC-RN649
0 986 357 171	RC-TX118
0 986 357 172	RC-OP403
0 986 357 174	RC-EN1206
0 986 357 176	RC-TE43
0 986 357 177	RC-NX91
0 986 357 178	RC-HD404
0 986 357 179	RC-NX89
0 986 357 180	RC-NE77A
0 986 357 181	RC-FT1203
0 986 357 182	RC-RN658
0 986 357 184	RC-RN1203
0 986 357 186	RC-EN1204
0 986 357 187	RC-RN602
0 986 357 188	RC-RV315
0 986 357 189	RC-OP448
0 986 357 191	RC-JG1205
0 986 357 192	RC-RV1301
0 986 357 193	RC-ST602
0 986 357 194	RC-ZE07
0 986 357 195	RC-ZE23
0 986 357 196	RC-ME51
0 986 357 197	RC-ME106A
0 986 357 198	RC-ET1217
0 986 357 199	RC-TE120
0 986 357 203	RC-KA404
0 986 357 204	RC-TE132
0 986 357 205	RC-EF1202
0 986 357 207	RC-ME95
0 986 357 208	RC-FD807
0 986 357 209	RC-RV410
0 986 357 210	RC-RN601
0 986 357 211	RC-RN652
0 986 357 212	RC-RV1206
0 986 357 213	RC-RV301

BOSCH	→ NGK
0 986 357 215	RC-ET1218
0 986 357 216	RC-RN651
0 986 357 217	RC-RV302
0 986 357 218	RC-ME78
0 986 357 219	RC-LC1202
0 986 357 220	RC-VL613
0 986 357 221	RC-FD1205
0 986 357 223	RC-RV1201
0 986 357 226	RC-OP304
0 986 357 227	RC-OP203
0 986 357 228	RC-OP465
0 986 357 229	RC-CR302
0 986 357 230	RC-RN623
0 986 357 231	RC-RN632
0 986 357 232	RC-VL605
0 986 357 233	RC-OP204
0 986 357 234	RC-OP438
0 986 357 235	RC-FD817
0 986 357 236	RC-RV303
0 986 357 237	RC-OP440
0 986 357 238	RC-RN608
0 986 357 239	RC-NX11
0 986 357 240	RC-CT615
0 986 357 241	RC-ZX29
0 986 357 242	RC-OP306
0 986 357 243	RC-RN645
0 986 357 244	RC-VL606
0 986 357 245	RC-FD826
0 986 357 246	RC-FD519
0 986 357 247	RC-OP444
0 986 357 248	RC-CR305
0 986 357 251	RC-CT601
0 986 357 258	RC-FT632
0 986 357 259	RC-TE51
0 986 357 261	RC-FT1202
0 986 357 262	RC-FX67
0 986 357 263	RC-SE17
0 986 357 265	RC-EZ1202
0 986 357 266	RC-ZE53
0 986 357 269	RC-AR601
0 986 357 276	RC-OP466
0 986 357 280	RC-EN1202
0 986 357 722	296 045
0 986 357 723	296 045
31 VA	210 040
44 VK	296 045
48 VK	296 045
A 100	411 100
A 30	411 030
A 40	411 040
A 50	411 050
A 60	411 060



BOSCH	→ NGK
A 70	411 070
A 80	411 080
A 90	411 090
B 010	RC-ST601
B 011	RC-OP459
B 012	RC-FD803
B 013	RC-VL612
B 014	RC-AR403
B 023	RC-VW215
B 025	RC-AD1101
B 063	RC-OP463
B 065	RC-RV1204
B 066	RC-FD1202
B 068	RC-SD1201
B 075	RC-AR603
B 076	RC-LC1301
B 077	RC-AR406
B 080	RC-FT442
B 081	RC-FT428
B 082	RC-FT431
B 084	RC-FT615
B 085	RC-FT414
B 086	RC-OP413
B 088	RC-LC403
B 089	RC-LC607
B 090	RC-FD545
B 091	RC-JG1202
B 092	RC-CR310
B 094	RC-RV404
B 095	RC-RV401
B 096	RC-FT607
B 098	RC-CR602
B 100	RC-RN409
B 101	RC-RN648
B 103	RC-AR414
B 104	RC-RV1207
B 106	RC-MX1201
B 108	RC-RV313
B 110	RC-JG1203
B 113	RC-LC606
B 114	RC-VX402
B 116	RC-PG406
B 118	RC-CR306
B 119	RC-FT624
B 120	RC-CT412
B 121	RC-PG618
B 122	RC-ME54
B 123	RC-PG1301
B 124	RC-OP434
B 125	RC-OP430
B 126	RC-OP1208
B 127	RC-OP436

BOSCH	→ NGK
B 128	RC-PG601
B 129	RC-FD824
B 130	RC-LC615
B 133	RC-FT415
B 135	RC-PG605
B 137	RC-RN639
B 140	RC-FD533
B 141	RC-FD808
B 142	RC-HD411
B 143	RC-OP450
B 144	RC-OP1209
B 145	RC-FD532
B 146	RC-LC610
B 148	RC-OP432
B 149	RC-ZE37
B 150	RC-HE82
B 151	RC-ME64
B 152	RC-RV412
B 153	RC-RV414
B 154	RC-RV1202
B 155	RC-RV305
B 156	RC-OP453
B 157	RC-EM1203
B 158	RC-RN603
B 159	RC-ME109
B 160	RC-RV1203
B 161	RC-SB605
B 162	RC-SB408
B 164	RC-JG1204
B 165	RC-EZ1210
B 166	RC-VL605
B 167	RC-OP1201
B 168	RC-DE11
B 170	RC-RN649
B 171	RC-TX118
B 172	RC-OP403
B 174	RC-EN1206
B 176	RC-TE43
B 177	RC-NX91
B 178	RC-HD404
B 179	RC-NX89
B 180	RC-NE77A
B 181	RC-FT1203
B 182	RC-RN658
B 184	RC-RN1203
B 186	RC-EN1204
B 187	RC-RN602
B 188	RC-RV315
B 189	RC-OP448
B 191	RC-JG1205
B 192	RC-RV1301
B 193	RC-ST602



BOSCH	→ NGK
B 194	RC-ZE07
B 195	RC-ZE23
B 196	RC-ME51
B 197	RC-ME106A
B 198	RC-ET1217
B 199	RC-TE120
B 203	RC-KA404
B 204	RC-TE132
B 205	RC-EF1202
B 207	RC-ME95
B 208	RC-FD807
B 209	RC-RV410
B 210	RC-RN601
B 211	RC-RN652
B 212	RC-RV1206
B 213	RC-RV301
B 215	RC-ET1218
B 216	RC-RN651
B 217	RC-RV302
B 218	RC-ME78
B 219	RC-LC1202
B 220	RC-VL613
B 221	RC-FD1205
B 223	RC-RV1201
B 226	RC-OP304
B 227	RC-OP203
B 228	RC-OP465
B 229	RC-CR302
B 230	RC-RN623
B 233	RC-OP204
B 234	RC-OP438
B 235	RC-FD817
B 236	RC-RV303
B 237	RC-OP440
B 239	RC-NX11
B 241	RC-ZX29
B 242	RC-OP306
B 245	RC-FD826
B 246	RC-FD519
B 247	RC-OP444
B 248	RC-CR305
B 259	RC-TE51
B 262	RC-FX67
B 263	RC-SE17
B 265	RC-EZ1202
B 266	RC-ZE53
B 276	RC-OP466
B 280	RC-EN1202
B 30	410 030
B 338	RC-VW215
B 339	RC-VW904
B 340	RC-AD216

BOSCH	→ NGK
B 341	RC-VW907
B 343	RC-VW903
B 351	RC-MB203
B 352	RC-MB220
B 355	RC-VW1101
B 359	RC-VW254
B 362	RC-BW218
B 376	RC-PS1103
B 377	RC-PS1102
B 40	410 040
B 50	410 050
B 60	410 060
B 70	410 070
B 700	RC-FD538
B 702	RC-NX71
B 703	RC-EN1203
B 705	RC-NE09
B 706	RC-FD1201
B 707	RC-RV322
B 709	RC-FT618
B 712	RC-LC609
B 714	RC-CR304
B 717	RC-FT604
B 718	RC-LC604
B 719	RC-MX401
B 720	RC-SB601
B 721	RC-HE64
B 722	RC-OP426
B 723	RC-OP455
B 724	RC-FD521
B 725	RC-CT411
B 726	RC-LD301
B 731	RC-RV415
B 732	RC-ES1202
B 735	RC-KA401
B 736	RC-LC614
B 737	RC-FT636
B 738	RC-FT628
B 739	RC-DW1201
B 741	RC-OP402
B 743	RC-RN629
B 744	RC-VL616
B 746	RC-OP423
B 747	RC-OP419
B 748	RC-RV413
B 749	RC-PG616
B 750	RC-SD401
B 751	RC-PG602
B 752	RC-FT620
B 754	RC-FT601
B 758	RC-ZX16
B 759	RC-RV406



BOSCH	→ NGK
B 761	RC-FT435
B 762	RC-SE83
B 763	RC-RV318
B 767	RC-CR601
B 768	RC-LD302
B 772	RC-RV304
B 773	RC-VL1301
B 774	RC-FD509
B 780	RC-RN627
B 781	RC-CT602
B 782	RC-HD409
B 783	RC-FD820
B 785	RC-ST404
B 786	RC-ST403
B 788	RC-JG1201
B 791	RC-FT603
B 792	RC-FT634
B 794	RC-CR604
B 795	RC-PG608
B 796	RC-OP447
B 797	RC-AT404
B 798	RC-RN620
B 80	410 080
B 800	RC-OP411
B 801	RC-OP418
B 803	RC-CT605
B 805	RC-FD546
B 806	RC-RV307
B 807	RC-NX93
B 811	RC-FT446
B 812	RC-ZE08
B 813	RC-HD408
B 814	RC-OP414
B 815	RC-EZ1208
B 816	RC-FT417
B 818	RC-FT1201
B 819	RC-RV323
B 820	RC-PG603
B 821	RC-NE08
B 823	RC-AR604
B 824	RC-VL607
B 825	RC-CT613
B 826	RC-OP427
B 827	RC-CT402
B 828	RC-ST405
B 829	RC-FD503
B 830	RC-CT615
B 831	RC-RV309
B 833	RC-FD1203
B 834	RC-CR309
B 835	RC-AR610
B 836	RC-FT608

BOSCH	→ NGK
B 838	RC-HD301
B 839	RC-ZE98
B 840	RC-LC617
B 843	RC-HD1201
B 844	RC-AT405
B 846	RC-FT609
B 848	RC-CT603
B 850	RC-OP412
B 851	RC-CT611
B 853	RC-FT621
B 854	RC-PG617
B 856	RC-AR602
B 857	RC-FT635
B 858	RC-FD530
B 860	RC-FD544
B 861	RC-LC611
B 862	RC-VX415
B 863	RC-PG615
B 864	RC-OP421
B 865	RC-AT402
B 866	RC-VL611
B 867	RC-RV604
B 868	RC-FD825
B 869	RC-FT605
B 870	RC-FD536
B 874	RC-FT631
B 875	RC-FT638
B 878	RC-AR907
B 879	RC-FD830
B 880	RC-FD804
B 881	RC-HD409
B 882	RC-FT420
B 883	RC-RN655
B 886	RC-OP408
B 887	RC-FD537
B 888	RC-RN637
B 889	RC-CT601
B 890	RC-VL608
B 891	RC-RV605
B 892	RC-LC201
B 897	RC-KA402
B 898	RC-HD1202
B 90	410 090
B 929	RC-ET1210
B 931	RC-TE24
B 934	RC-ET1201
B 937	RC-ET1213
B 941	RC-TE83
B 947	RC-TX08
B 948	RC-TX02
B 949	RC-ET1207
B 953	RC-ET1208



BOSCH	→ NGK
B 954	RC-TE87
B 955	RC-ET1203
B 957	RC-TE41
B 959	RC-FD1204
B 963	RC-EH1201
B 964	RC-RN653
B 965	RC-RN653
B 966	RC-ZE31
B 967	RC-RN606
B 980	RC-DW301
B 982	RC-KA1203
B 984	RC-ST406
B 987	RC-DW1203
B 988	RC-DW304
B 991	RC-HD1204
BW 231	RC-RN632
BW 232	RC-VL605
BW 238	RC-RN608
BW 240	RC-CT615
BW 243	RC-RN645
BW 244	RC-VL606
BW 251	RC-CT601
BW 258	RC-FT632
BW 261	RC-FT1202
BW 269	RC-AR601
EE 857	RC-AD1102
G 60	410 060
G 80	410 080
H 40	424 040
H 50	424 050
H 60	424 060
OB 70	418 075
OC 50	419 050
OC 70	419 070
OF 30	451 030
OF 50	451 050
Y 30	414 030
Y 40	414 040
Y 50	414 050
Y 60	414 060
Y 70	414 070
BOUGICORD	→ NGK
1 412	RC-RN646
1 413	RC-RN655
1 416	RC-RN627
1 417	RC-RN653
1 420	RC-RN623
1 429	RC-RN603
1 431	RC-RN606
1 434	RC-RN602

BOUGICORD	→ NGK
2 413	RC-RN1301
2 421	RC-VL604
2 423	RC-RN1301
2 425	RC-VL607
2 445	RC-RN651
2 451	RC-RN640
2 456	RC-RN637
2 457	RC-RN652
2 458	RC-RN1203
2 476	RC-RN645
2 481	RC-LC1202
2 492	RC-RN649
2 496	RC-RN632
2 497	RC-VL607
3 104	RC-CT402
3 114	RC-CT1304
3 140	RC-CT402
3 143	RC-CT402
3 166	RC-CT402
3 170	RC-CT611
3 175	RC-CT406
3 190	RC-CT602
3 192	RC-CT611
3 317	RC-PG608
3 337	RC-VL613
3 373	RC-PG604
3 374	RC-PG406
3 375	RC-RN619
3 379	RC-PG607
3 395	RC-PG608
3 398	RC-CT601
3 413	RC-RN639
3 418	RC-FT638
3 462	RC-RN640
3 463	RC-RN1302
3 466	RC-RN619
3 497	RC-RN650
3 519	RC-PG605
4 002	RC-SD1201
4 005	RC-MX401
4 006	RC-ST405
4 007	RC-ST406
4 008	RC-LD301
4 009	RC-PG406
4 011	RC-AT405
4 014	RC-MX401
4 015	RC-DW304
4 016	RC-AT402
4 017	RC-AT404
4 020	RC-ST404
4 021	RC-VX402
4 025	RC-OP459



BOUGICORD	→ NGK
4 027	RC-EN1204
4 033	RC-CT612
4 038	RC-AR406
4 060	RC-RV304
4 061	RC-FT609
4 081	RC-LC615
4 100	RC-VW225
4 101	RC-AD210
4 102	RC-VW215
4 103	RC-AD216
4 104	RC-AD212
4 105	RC-BW210
4 106	RC-BW232
4 109	RC-BW1101
4 111	RC-MB211
4 113	RC-VW210
4 114	RC-MB208
4 117	RC-AD216
4 118	RC-FT615
4 119	RC-SB601
4 121	RC-FD519
4 122	RC-OP455
4 123	RC-OP426
4 126	RC-DW401
4 128	RC-DW402
4 131	RC-AD208
4 147	RC-FD826
4 148	RC-FD546
4 149	RC-FD538
4 150	RC-FD537
4 152	RC-OP463
4 153	RC-FT602
4 154	RC-VW214
4 155	RC-VW214
4 156	RC-OP204
4 158	RC-FT601
4 159	RC-FT628
4 162	RC-FT1201
4 163	RC-OP438
4 164	RC-OP418
4 167	RC-ZX29
4 168	RC-FT623
4 169	RC-BW210
4 170	RC-BW232
4 171	RC-BW223
4 172	RC-AD204
4 173	RC-VW254
4 174	RC-BW1101
4 175	RC-BW232
4 176	RC-FD544
4 177	RC-LC201
4 178	RC-FD808

BOUGICORD	→ NGK
4 179	RC-AD212
4 193	RC-FD1205
4 194	RC-FD808
4 196	RC-ST901
4 200	RC-OP466
4 204	RC-FT632
4 205	RC-VW232
4 206	RC-FT1203
4 207	RC-VW910
4 303	RC-PG601
4 304	RC-PG615
4 306	RC-PG602
4 310	RC-CR604
4 313	RC-PG605
4 319	RC-CT412
4 325	RC-PG609
4 326	RC-PG1301
4 331	RC-CR601
4 333	RC-CR602
4 334	RC-CT615
4 404	RC-RN640
4 405	RC-RN620
4 474	RC-VL616
4 486	RC-RN619
5 101	RC-OP440
6 101	RC-RV1302
6 201	RC-AR403
6 202	RC-AR406
6 203	RC-AR406
6 204	RC-AR604
6 205	RC-AR204
6 206	RC-AR903
6 207	RC-AR610
6 407	RC-VL613
6 424	RC-VL614
6 431	RC-VL606
6 435	RC-VL602
6 462	RC-RN608
6 467	RC-VL606
6 468	RC-VL605
6 469	RC-VL605
6 503	RC-SB408
6 518	RC-SB601
6 522	RC-SB604
6 530	RC-SB605
7 103	RC-AR908
7 104	RC-LD302
7 110	RC-CR310
7 113	RC-AR204
7 114	RC-FT1204
7 116	RC-AR908
7 120	RC-LD302



BOUGICORD	→ NGK
7 121	RC-ST406
7 123	RC-FT431
7 125	RC-FD530
7 129	RC-HD408
7 130	RC-HD301
7 136	RC-ME59
7 142	RC-ET1210
7 143	RC-ET1210
7 147	RC-RV604
7 148	RC-RV603
7 149	RC-RV1302
7 151	RC-ZE28
7 153	RC-VW201
7 154	RC-MB217
7 155	RC-MB1105
7 160	RC-MB209
7 163	RC-MB216
7 165	RC-MB209
7 168	RC-MB211
7 180	RC-MB216
7 193	RC-ET1214
7 195	RC-ET1213
7 200	RC-ET1227
7 203	RC-RV605
7 204	RC-RV304
7 205	RC-RV605
7 206	RC-RV603
7 207	RC-RV603
7 208	RC-RV304
7 210	RC-RV603
7 214	RC-RV413
7 215	RC-DW302
7 216	RC-DW302
7 217	RC-FD817
7 218	RC-FD509
7 220	RC-FD825
7 221	RC-FD803
7 223	RC-JG1203
7 225	RC-JG1204
7 226	RC-JG1205
7 227	RC-RV406
7 231	RC-OP412
7 232	RC-OP412
7 233	RC-RV304
7 234	RC-ME59
7 235	RC-RV307
7 240	RC-AD202
7 241	RC-OP418
7 244	RC-VW1102
7 245	RC-VW215
7 246	RC-VW210
7 247	RC-VW210

BOUGICORD	→ NGK
7 248	RC-VW210
7 249	RC-VW1102
7 250	RC-FT446
7 251	RC-FT635
7 254	RC-EH1201
7 255	RC-FT636
7 256	RC-FT636
7 257	RC-FT604
7 258	RC-FT420
7 259	RC-FT636
7 260	RC-FT631
7 261	RC-FT415
7 263	RC-MB203
7 264	RC-LC606
7 265	RC-FT605
7 266	RC-FT605
7 267	RC-FT618
7 268	RC-FT631
7 270	RC-FT605
7 271	RC-FT417
7 272	RC-ST404
7 273	RC-FT603
7 275	RC-FT428
7 276	RC-LC201
7 277	RC-LC615
7 278	RC-LC614
7 279	RC-LC616
7 280	RC-LC616
7 281	RC-FT624
7 282	RC-FT634
7 283	RC-LC604
7 284	RC-FT203
7 285	RC-LC604
7 287	RC-FT635
7 291	RC-FT634
7 292	RC-ME59
7 293	RC-RV323
7 296	RC-ST404
7 297	RC-FT624
7 298	RC-KA404
7 299	RC-OP408
7 349	RC-CR602
7 377	RC-RN623
7 380	RC-RN608
7 381	RC-RN602
7 409	RC-TE24
7 412	RC-HD407
7 413	RC-HD411
7 414	RC-HD1201
7 415	RC-SE02
7 416	RC-AR903
7 418	RC-FD546



BOUGICORD	→ NGK
7 419	RC-FD807
7 421	RC-VW249
7 423	RC-AD201
8 106	RC-FT444
8 107	RC-FT444
9 218	RC-VW1101
9 219	RC-VW215
9 220	RC-AD216
9 221	RC-BW231
9 222	RC-BW210
9 223	RC-BW232
9 224	RC-BW230
9 225	RC-BW218
9 226	RC-BW1101
9 227	RC-MB1105
9 228	RC-MB1102
9 229	RC-AD212
9 230	RC-MB211
9 231	RC-VW210
9 232	RC-MB218
9 233	RC-MB209
9 234	RC-VW1102
9 235	RC-VW214
9 297	RC-MB206
9 303	RC-AR913
9 379	RC-AD211
9 380	RC-VW905
9 381	RC-VW1103
9 382	RC-VW1104
9 433	RC-VW242
9 436	RC-ST902
9 437	RC-VW219
9 490	RC-VW209
9 494	RC-VW207
9 498	RC-VW239
9 499	RC-VW220
9 500	RC-VW206
9 504	RC-VW208
9 505	RC-AD205
9 509	RC-MB213
9 511	RC-BW213
9 512	RC-BW223
9 514	RC-MB214
9 515	RC-MB212
9 522	RC-MB201
9 523	RC-VW254
9 524	RC-AD215
9 525	RC-VW211
9 526	RC-FT202
9 528	RC-VW223
9 529	RC-VW201
9 535	RC-AD1104

BOUGICORD	→ NGK
9 538	RC-AD209
9 539	RC-MB217
9 541	RC-MB1102
9 542	RC-MB208
9 583	RC-VW230
9 597	RC-MB203
9 608	RC-AD202
9 609	RC-AD1101
9 611	RC-VW912
9 612	RC-VW225
9 617	RC-BW208
9 643	RC-VW902
9 646	RC-AR906
9 652	RC-AR908
9 678	RC-PS1101
9 679	RC-AR911
9 683	RC-FT203
9 700	RC-AR912
9 702	RC-VW232
9 704	RC-LC901
9 711	RC-VW910
9 732	RC-AR204
9 743	RC-MB219
9 751	RC-AR914
9 752	RC-AR205
9 763	RC-AR201
9 768	RC-AD208
9 777	RC-AD201
9 793	RC-AR903
9 794	RC-AR901
9 795	RC-AR917
9 796	RC-AD204
9 797	RC-AD206
9 798	RC-AD207
9 799	RC-AD210
9 800	RC-AD1101
9 801	RC-AD218
9 802	RC-AD219
9 803	RC-VW218
9 804	RC-VW236
9 805	RC-BW205
9 806	RC-BW222
9 807	RC-BW225
9 808	RC-BW233
9 809	RC-BW235
9 820	RC-FT201
9 828	RC-FD901
9 831	RC-LC1301
9 835	RC-MB202
9 836	RC-MB222
9 837	RC-MB207
9 838	RC-MB215



BOUGICORD	→ NGK
9 839	RC-MB220
9 840	RC-MB223
9 841	RC-MB225
9 842	RC-OP201
9 843	RC-OP202
9 854	RC-ST204
9 856	RC-AD1102
9 857	RC-VW203
9 858	RC-VW246
9 859	RC-VW247
9 861	RC-VW249
9 862	RC-ST201
9 864	RC-VW216
9 865	RC-VW227
9 866	RC-VW233
9 867	RC-VW235
9 868	RC-VW235
9 869	RC-VW249
9 870	RC-VW235
9 871	RC-VW244
9 872	RC-VW249
9 873	RC-VW903
9 874	RC-VW904
9 875	RC-VW907
9 880	RC-MB216
11 171	451 030
11 202	414 030
11 232	414 030
14 855	414 040
14 885	414 040
18 445	450 050
18 476	451 050
18 507	414 050
18 537	414 050
22 160	414 060
22 190	414 060
25 812	414 070
25 842	414 070
7 / 100	450 100
B 80	411 080
B 90	411 090
C 30	410 030
C 40	410 040
C 50	410 050
C 60	410 060
C 70	410 070
C 80	410 080
C 90	410 090
P 75	418 075
Q 50	419 050
Q 70	419 070

BREMI	→ NGK
210	RC-OP201
225	RC-MB201
226	RC-MB202
227	RC-MB203
236	RC-AD202
243	RC-AR201
250	RC-AD216
251	RC-AD204
252	RC-AD205
253	RC-AD206
255	RC-AD207
256	RC-AD208
257	RC-MB206
260	RC-MB209
263	RC-MB211
264	RC-MB212
265	RC-MB213
266	RC-AD209
270	RC-VW207
271	RC-VW208
272	RC-VW209
274	RC-AD210
280	RC-MB214
295	RC-ST201
299	RC-VW210
403	RC-MB215
404	RC-MB216
426	RC-OP202
427	RC-OP203
428	RC-OP204
430	RC-MB217
447	RC-AD211
478	RC-MB218
539	RC-VW216
565	RC-AD212
626	RC-VW217
705	RC-BW1201
795	RC-MB219
901	RC-LC901
904	RC-AR901
910	RC-FD901
912	RC-AR903
915	RC-AR906
919	RC-VW902
920	RC-AR907
922	RC-AR908
925	RC-VW905
928	RC-AR911
931	RC-AD219
932	RC-LC1301
933	RC-MB223
954	RC-VW239



BREMI	→ NGK
956	RC-AR204
957	RC-LC201
958	RC-VW219
959	RC-VW225
961	RC-VW227
964	RC-VW230
971	RC-AR912
972	RC-AR913
973	RC-AR205
975	RC-AD1101
977	RC-VW232
978	RC-VW233
979	RC-FT201
981	RC-MB220
983	RC-MB222
989	RC-VW219
990	RC-VW220
991	RC-VW239
994	RC-FT202
995	RC-FT203
996	RC-AD1101
997	RC-VW223
998	RC-AD215
500 106	RC-ET1221
104/62	RC-VW201
104/70	204 070
104/86	204 080
104/90	204 090
104/98	204 100
110/30	210 030
110/35	210 040
110/40	210 040
110/50	210 050
110/60	210 060
111/40	211 040
111/50	211 050
111/55	211 060
111/60	211 060
111/70	211 070
111/80	211 080
111/A47	211 050
111/A52	211 050
111/A66	211 070
113/80	213 080
113/85	213 085
114/40	214 040
114/50	214 050
114/55	214 060
114/75	214 070
115/30	RC-AD215
115/40	215 040
115/55	215 060

BREMI	→ NGK
115/60	215 060
115/70	215 070
117/50	217 045
117/60	217 055
120/55	RC-BW233
121/105	221 105
121/120	221 120
121/130	221 130
123/55	RC-BW223
128/65	226 060
132/80	232 080
137/27	226 026
137/30	RC-BW208
150/50	RC-MB211
150/80	RC-MB211
150/85	RC-MB207
151/55	RC-MB206
151/80	RC-MB206
154/75	RC-VW218
162/27	293 030
162/66	293 065
166/33	294 050
171/60	RC-AD215
172/55	272 055
187/45	RC-MB201
193/52	293 050
193/69	293 070
193/86	293 080
194/55	294 055
195/30	295 030
195/40	295 040
195/55	295 055
195/65	295 070
196/42	296 045
196/44	296 045
196/48	296 045
1A02/F59	236 060
1A02/F85	236 085
1A06/50	131 050
1A09/32	131 030
1A09/48	131 040
1A09/60	131 060
1A14/65	144 060
1A14/66	144 070
1A14/79	RC-VW247
1A32/E44	293 040
1A32/E58	293 060
1A62/F59	236 060
203/200	RC-BW235
205/200	RC-VW235
205E/200	RC-VW235
205F/200	RC-VW235



BREMI	→ NGK
205H/200	RC-VW247
206F/200	RC-VW249
206M/200	RC-VW249
210/26	293 020
212/14	RC-AR903
212/33	RC-AR903
212AD/200	RC-VW244
212F/200	RC-VW201
220H/200	RC-VW910
221E/200	RC-VW249
221F/200	RC-VW254
222D/200	RC-AD201
222G/200	RC-VW236
223E/200	RC-VW203
223H/200	RC-ST204
229AB/200	RC-MB225
231J/100	RC-VW242
233/200	RC-AD218
281/100	RC-BW205
287/200	RC-BW208
296B	RC-VW246
300/103	RC-AR403
300/106	RC-AR406
300/124	RC-MX401
300/129	RC-AT402
300/132	RC-AT405
300/141	RC-VX402
300/163	RC-CT402
300/171	RC-CT405
300/172	RC-CT406
300/183	RC-CT411
300/192	RC-DE11
300/214	RC-FT414
300/216	RC-FT415
300/219	RC-FT417
300/220	RC-FT418
300/222	RC-FT420
300/234	RC-FT428
300/238	RC-FT431
300/294	RC-EH1201
300/304	RC-LD301
300/306	RC-PG406
300/307	RC-ST403
300/311	RC-LC403
300/320	RC-OP421
300/373	RC-OP402
300/374	RC-OP403
300/377	RC-OP402
300/379	RC-OP301
300/380	RC-OP408
300/381	RC-OP408
300/383	RC-FT435

BREMI	→ NGK
300/386	RC-OP411
300/387	RC-OP412
300/388	RC-OP413
300/389	RC-OP414
300/394	RC-OP419
300/396	RC-OP421
300/397	RC-OP426
300/398	RC-OP423
300/400	RC-RV401
300/412	RC-LD301
300/417	RC-ME51
300/435	RC-EN1211
300/478	RC-FT431
300/486	RC-PG406
300/521	RC-OP426
300/528	RC-OP427
300/541	RC-RN409
300/562	RC-RV404
300/564	RC-RV1204
300/568	RC-RV406
300/575	RC-SB406
300/578	RC-ST405
300/579	RC-ST406
300/585	RC-SD401
300/601	RC-CT412
300/625	RC-CT615
300/648	RC-OP430
300/649	RC-OP1213
300/651	RC-OP432
300/655	RC-OP434
300/670	RC-KA401
300/675	RC-OP440
300/676	RC-HD404
300/677	RC-FT442
300/678	RC-OP1208
300/679	RC-OP442
300/680	RC-OP1218
300/681	RC-OP444
300/686	RC-OP447
300/687	RC-OP448
300/688	RC-OP1208
300/689	RC-OP450
300/692	RC-OP453
300/694	RC-OP1209
300/695	RC-KA402
300/697	RC-KA404
300/699	RC-KA1205
300/700	RC-FT444
300/701	RC-HD407
300/702	RC-HD408
300/703	RC-HD409
300/704	RC-ME96



BREMI	→ NGK
300/708	RC-HD411
300/709	RC-FT454
300/711	RC-ZE37
300/715	RC-ZE21
300/716	RC-ZE36
300/720	RC-SB408
300/721	RC-DW401
300/722	RC-DW402
300/723	RC-DW403
300/725	RC-RV410
300/727	RC-RV412
300/728	RC-RV413
300/729	RC-RV414
300/731	RC-RV415
300/733	RC-RV301
300/735	RC-RV303
300/736	RC-RV304
300/737	RC-RV305
300/742	RC-RV307
300/746	RC-RV308
300/748	RC-ME79
300/751	RC-ME109
300/755	RC-ME64
300/758	RC-DW301
300/759	RC-DW302
300/762	RC-RV309
300/763	RC-RV323
300/766	RC-OP440
300/767	RC-CR301
300/768	RC-CR302
300/769	RC-CR302
300/770	RC-CR304
300/771	RC-CR305
300/772	RC-CR306
300/773	RC-GM1202
300/775	RC-ME111
300/776	RC-CR308
300/777	RC-CR309
300/779	RC-CR310
300/781	RC-RV313
300/782	RC-RV406
300/783	RC-RV315
300/785	RC-HD301
300/786	RC-HD411
300/787	RC-OP304
300/788	RC-ZX29
300/789	RC-NX71
300/790	RC-NX89
300/791	RC-NE77A
300/792	RC-AT405
300/793	RC-RV318
300/794	RC-RV316

BREMI	→ NGK
300/796	RC-TX05
300/798	RC-TX02
300/799	RC-TE83
300/869	RC-OP455
300/877	RC-OP1217
300/884	RC-OP458
300/885	RC-OP466
300/904	RC-FT446
300/913	RC-SE77
300/919	RC-OP1204
300/945	RC-CT601
300/967	RC-ST406
300/988	RC-EF1202
300/992	RC-AR414
310/30	410 030
310/40	410 040
310/50	410 050
310/60	410 060
310/70	410 070
310/80	410 080
310/90	410 090
311/100	411 100
311/30	411 030
311/40	411 040
311/50	411 050
311/60	411 060
311/70	411 070
311/80	411 080
311/90	411 090
313/30	424 030
313/40	424 040
314/30	414 030
314/40	414 040
314/50	414 050
314/60	414 060
314/70	414 070
317/30	417 030
318/75	418 075
319/50	419 050
323/40	423 040
323/50	423 050
323/60	423 060
323/80	423 080
324/40	424 040
324/50	424 050
324/60	424 060
327/40	427 040
327/52	427 050
346/23	359 040
346/32	359 040
346/40	359 040
346/54	359 050



BREMI	→ NGK
350/100	450 100
350/50	450 050
351/30	451 030
351/50	451 050
352/30	RC-KA1202
352/40	RC-KA1202
352/45	RC-KA1202
358/E96	RC-CR306
369/40	469 040
369/60	469 060
370/20	470 025
370/27	470 025
370/30	470 040
370/40	470 040
370/50	470 050
370/60	470 060
370/66	470 070
370/70	470 070
379/18	479 030
379/27	479 030
379/35	479 040
379/39	479 040
379/43	479 050
379/52	479 050
379/53	479 055
379/57	479 055
379/65	479 070
381/18	481 030
381/24	481 030
381/33	481 030
381/36	481 040
381/52	481 050
381/63	481 060
381/65	481 070
381/77	481 080
382/40	482 040
386/40	486 040
386/45	486 050
386/50	486 050
386/60	486 060
386/65	486 070
386/75	486 080
3A00/101	RC-TE93
3A00/102	RC-TX08
3A00/103	RC-ET1203
3A00/114	RC-ME78
3A00/117	RC-ES1202
3A00/118	RC-SE83
3A00/121	RC-ED1203
3A00/125	RC-DW304
3A00/136	RC-OP1209
3A00/142	RC-RV302

BREMI	→ NGK
3A00/145	RC-RV322
3A00/146	RC-RV323
3A00/150	RC-OP307
3A00/159	RC-KA1206
3A00/166	RC-CR1203
3A00/171	RC-ZE07
3A00/178	RC-OP1216
3A00/179	RC-OP1215
3A00/180	RC-OP1210
3A00/181	RC-ET1211
3A00/186	RC-KA1204
3A16/44	353 040
3A16/50	353 050
3A37/22	RC-FD1209
3A37/33	RC-FD1209
3A37/46	RC-FD1209
3A45/E80	RC-FX51
3A48/E45	RC-OP1101
3A66/28	402 030
3A66/36	402 040
3A66/44	402 050
406/200	RC-VW211
446/20	346 020
446/33	346 030
446/45	346 050
464/100	RC-BW210
468/26	368 030
468/35	368 040
468/40	368 040
468/47	368 050
468/60	368 060
473/100	RC-VW214
496F/59	360 060
500/101	RC-TE42
500/103	RC-ET1213
500/104	RC-TE43
500/107	RC-TE68
500/108	RC-TE132
500/111	RC-TE41
500/116	RC-ET1214
500/117	RC-TE58
500/118	RC-TE51
500/122	RC-ME95
500/125	RC-TX118
500/129	RC-ET1229
503A/100	RC-BW213
538/100	RC-BW218
571/100	RC-BW223
573/100	RC-BW225
600/103	RC-VL604
600/104	RC-RN637
600/106	RC-RN645



BREMI	→ NGK
600/110	RC-CT601
600/115	RC-PG602
600/116	RC-PG609
600/118	RC-CT615
600/119	RC-NE29
600/121	RC-VL613
600/122	RC-VL614
600/124	RC-VL606
600/126	RC-EN1203
600/138	RC-CR601
600/139	RC-PG611
600/143	RC-CR602
600/145	RC-VL608
600/147	RC-RN646
600/149	RC-RN1301
600/150	RC-RN648
600/151	RC-RN649
600/154	RC-CT602
600/155	RC-CT611
600/157	RC-PG604
600/158	RC-PG612
600/163	RC-RN639
600/164	RC-RN1306
600/165	RC-RN650
600/167	RC-CT603
600/172	RC-RN651
600/179	RC-PG601
600/180	RC-CR604
600/182	RC-FT628
600/185	RC-RN640
600/186	RC-RN620
600/188	RC-VL616
600/195	RC-RN620
600/199	RC-RN652
600/200	RC-RN601
600/202	RC-RN602
600/203	RC-RN623
600/205	RC-RN603
600/211	RC-SB601
600/213	RC-SB601
600/214	RC-SB604
600/215	RC-FT1202
600/216	RC-CR602
600/217	RC-FT601
600/218	RC-FT602
600/220	RC-PG615
600/221	RC-PG603
600/222	RC-AR601
600/223	RC-AR602
600/225	RC-NE08
600/227	RC-NX11
600/228	RC-HE73

BREMI	→ NGK
600/231	RC-RV1302
600/234	RC-RV603
600/239	RC-ZX29
600/241	RC-ZX16
600/242	RC-EZ1208
600/243	RC-RV303
600/249	RC-EN1206
600/250	RC-NE09
600/251	RC-SB605
600/254	RC-RV604
600/257	RC-NX07
600/259	RC-FT603
600/262	RC-FT604
600/263	RC-FT605
600/266	RC-FT607
600/267	RC-FT608
600/268	RC-FT609
600/274	RC-FT615
600/276	RC-LC604
600/278	RC-LC606
600/281	RC-VL601
600/284	RC-VL611
600/285	RC-VL609
600/287	RC-AR603
600/288	RC-RN653
600/289	RC-RN653
600/290	RC-VL602
600/293	RC-RV605
600/298	RC-ET1301
600/305	RC-AR604
600/309	RC-RN606
600/312	RC-LC607
600/314	RC-FT620
600/315	RC-RN627
600/316	RC-RN627
600/319	RC-RN629
600/322	RC-FT618
600/324	RC-RN632
600/325	RC-RN608
600/328	RC-RN655
600/333	RC-EH1202
600/334	RC-RN611
600/349	RC-FT621
600/350	RC-LC609
600/353	RC-CT605
600/356	RC-FT635
600/357	RC-ZE28
600/358	RC-CT402
600/359	RC-CT612
600/361	RC-LC610
600/362	RC-LC611
600/364	RC-LC612



BREMI	→ NGK
600/365	RC-NE08
600/376	RC-ET1218
600/379	RC-ET1212
600/380	RC-VL612
600/382	RC-HE86
600/388	RC-AR602
600/393	RC-ZE98
600/397	RC-ZX14
600/399	RC-ZE06
600/401	RC-ZE23
600/402	RC-PG607
600/405	RC-NX91
600/408	RC-RV303
600/409	RC-ST1201
600/410	RC-ST601
600/413	RC-RN658
600/414	RC-AR610
600/416	RC-FT631
600/418	RC-LC614
600/420	RC-LC615
600/421	RC-LC616
600/425	RC-ET1217
600/426	RC-TX06
600/427	RC-FT632
600/428	RC-FT1203
600/431	RC-VL606
600/432	RC-PG616
600/435	RC-ST602
600/437	RC-FT634
600/438	RC-FT1206
600/439	RC-FT636
600/443	RC-ZE23
600/447	RC-CR606
600/448	RC-ET1202
600/450	RC-PG617
600/452	RC-CT613
600/454	RC-CT615
600/455	RC-LC617
600/456	RC-LC618
600/457	RC-FT638
600/458	RC-FT1207
600/459	RC-PG618
600/460	RC-FD1201
600/468	RC-TX99A
600/470	RC-HD1203
600/478	RC-RV1301
600/479	RC-SE17
600/481	RC-HD1202
600/486	RC-HD1205
600/496	RC-FD1209
607/60	RC-RN619
612/50	444 050

BREMI	→ NGK
624/48	724 050
624/60	724 060
624/68	724 070
625/35	725 030
625/40	725 040
631/35	731 030
631/40	731 040
631/50	731 050
631/60	731 060
631/70	731 070
631/80	731 080
656/40	RC-VL616
666/35	766 030
666/40	766 040
666/50	766 050
667/65	767 060
667/70	767 070
667/80	767 080
672/40	RC-VL606
672/51	RC-VL606
672/60	RC-VL606
675/50	775 050
675/65	775 060
675/90	775 090
677/55	777 050
677/75	RC-VL606
699/80	RC-CR602
6A10/28	643 030
6A84/42	RC-FD1210
737/35	351 045
737/56	351 065
759/40	643 040
759/50	643 050
759/59	643 060
760/35	RC-RN608
771/37	334 040
782/100	RC-BW231
784A/100	RC-BW232
786/100	RC-BW233
787/40	RC-VL607
787/63	687 070
800/174	RC-FD807
800/181	RC-FD830
800/185	RC-FD803
800/186	RC-FD804
800/187	RC-FD521
800/189	RC-FD807
800/190	RC-FD808
800/195	RC-FD813
800/198	RC-FD545
800/199	RC-FD817
800/204	RC-FD820



BREMI	→ NGK
800/208	RC-FD824
800/209	RC-FD825
800/210	RC-FD826
800/211	RC-FD544
800/213	RC-FD546
800/215	RC-FD548
800/216	RC-FD503
800/243	RC-FD508
800/247	RC-FD509
800/258	RC-FD519
800/259	RC-FD520
800/260	RC-FD521
800/279	RC-FD530
800/872	RC-FD532
800/906	RC-FD533
800/933	RC-FD536
800/939	RC-FD537
800/940	RC-FD538
800L/200	RC-FD1204
800R/200	RC-FD1204
813/15	513 020
813/30	513 035
813/40	513 050
813/45	513 050
816/100	516 100
816/80	516 080
818/45	RC-FD545
860/60	577 061
860/65	577 061
860/80	577 080
860/85	577 080
861/40	561 040
861/50	561 050
861/55	561 050
861/60	561 060
884/37	584 040
884/78	584 080
886/44	586 040
893/101	RC-FD503
893/69	RC-FD537
893/94	RC-FD503
897/14	597 020
897/28	597 025
897/37	297 040
897/43	597 050
923/100	RC-VW903
939B/200	RC-VW907
939C/200	RC-ST901
968G/100	RC-VW910
9A03/200	RC-RV901
9A04	RC-MB1103
9A05	RC-LC901

BREMI	→ NGK
9A07	RC-AR914
9A11	RC-AR917
9A13	RC-ST902
9A15/200	RC-VW1105
9A19	RC-VW912
9A30B200	RC-VW1110
CENTRO	→ NGK
1 / 30	410 030
10 959	410 030
3 / 30	411 030
11 018	411 030
5 / 30	414 030
11 079	414 030
1 / 40	410 040
14 611	410 040
3 / 40	411 040
14 671	411 040
5 / 40	414 040
14 732	414 040
1 / 50	410 050
18 264	410 050
3 / 50	411 050
18 323	411 050
5 / 50	414 050
18 384	414 050
1 / 60	410 060
21 916	410 060
3 / 60	411 060
21 976	411 060
5 / 60	414 060
22 037	414 060
1 / 70	410 070
25 569	410 070
3 / 70	411 070
25 628	411 070
5 / 70	414 070
25 689	414 070
1 / 80	410 080
29 221	410 080
3 / 80	411 080
29 281	411 080
1 / 90	410 090
32 874	410 090
3 / 90	411 090
32 933	411 090
33 / 70	418 075
34 / 50	419 050
34 / 70	419 070
38 / 40	411 040
38 / 70	411 070



CHAMPION	→ NGK
CL 1 A 30	411 030
CL 1 C 30	414 030
CL 1 M 30	410 030
CL 2 A 40	411 040
CL 2 C 40	414 040
CL 2 M 40	410 040
CL 3 E 45	410 040
CL 3 F 45	414 030
CL 4 A 50	411 050
CL 4 C 30	414 030
CL 4 C 50	414 050
CL 4 M 50	410 050
CL 5 A 60	411 060
CL 5 C 60	414 060
CL 5 M 60	410 060
CL 6 A 70	411 070
CL 6 M 70	410 070
CL 7 A 80	411 080
CL 7 M 80	410 080
CL 8 A 90	411 090
CL 8 M 90	410 090
CLS 23	RC-MB206
CLS 24	RC-MB209
CLS 25	RC-MB207
L 0430	414 030
L 0440	414 040
L 0450	414 050
L 0460	414 060
L 0470	414 070
L 07100	411 100
L 0730	411 030
L 0740	411 040
L 0750	411 050
L 0760	411 060
L 0770	411 070
L 0780	411 080
L 0790	411 090
L 0940	424 050
L 0950	424 050
L 0960	424 060
L 1440	423 040
L 1450	423 050
L 1460	423 060
L 1470	423 070
L 1530	417 030
L 1950	419 050
L 1970	419 070
L 2260	424 060
L 3530	451 030
L 3550	451 050
LK 0155	RC-BW223
LK 0335	226 035

CHAMPION	→ NGK
LK 0355	226 055
LK 05105	221 105
LK 0595	221 095
LK 0680	232 080
LK 1075	RC-MB211
LK 1430	210 030
LK 1440	210 040
LK 1450	210 050
LK 1460	210 060
LK 1540	211 040
LK 1550	211 050
LK 1560	211 060
LK 1570	211 070
LK 1580	211 080
LK 1640	214 040
LK 1660	214 060
LK 1730	RC-AD215
LK 1740	215 040
LK 1760	215 060
LS-04	RC-LC1201
LS-04 /190	RC-LC1201
LS-100	RC-RV303
LS-100 /190	RC-RV303
LS-101	RC-FT620
LS-101 /190	RC-FT620
LS-102	RC-FT604
LS-102 /190	RC-FT604
LS-104	RC-RV304
LS-104 /190	RC-RV304
LS-105	RC-RV1302
LS-105 /190	RC-RV1302
LS-106	RC-VX1201
LS-106 /190	RC-VX1201
LS-108	RC-LD301
LS-108 /195	RC-LD301
LS-109	RC-LD302
LS-109 /195	RC-LD302
LS-112	RC-MX401
LS-112 /190	RC-MX401
LS-122	RC-AR414
LS-122 /190	RC-AR414
LS-126	RC-FD830
LS-126 /190	RC-FD830
LS-127	RC-ZE28
LS-127 /190	RC-ZE28
LS-128	RC-JG1201
LS-128 /190	RC-JG1201
LS-129	RC-OP414
LS-129 /190	RC-OP414
LS-132	RC-VL608
LS-132 /190	RC-VL608
LS-133	RC-RV307



CHAMPION	→ NGK
LS-133 /190	RC-RV307
LS-135	RC-FT628
LS-135 /190	RC-FT628
LS-136	RC-CR302
LS-136 /190	RC-CR302
LS-141	RC-HD408
LS-141 /190	RC-HD408
LS-143	RC-OP450
LS-143 /190	RC-OP450
LS-145	RC-VL606
LS-145 /190	RC-VL606
LS-146	RC-RV415
LS-146 /190	RC-RV415
LS-147	RC-RV316
LS-147 /190	RC-RV316
LS-148	RC-SB604
LS-148 /190	RC-SB604
LS-149	RC-RN601
LS-149 /190	RC-RN601
LS-151	RC-RN645
LS-151 /190	RC-RN645
LS-153	RC-VL614
LS-153 /190	RC-VL614
LS-155	RC-KA402
LS-155 /190	RC-KA402
LS-166	RC-FD548
LS-166 /190	RC-FD548
LS-167	RC-FD544
LS-167 /190	RC-FD544
LS-168	RC-FD1204
LS-168 /190	RC-FD1204
LS-169	RC-CR310
LS-169 /190	RC-CR310
LS-17	RC-OP426
LS-17 /190	RC-OP426
LS-170	RC-SB601
LS-170 /190	RC-SB601
LS-172	RC-RN652
LS-172 /190	RC-RN652
LS-173	RC-FT1202
LS-173 /190	RC-FT1202
LS-174	RC-FT618
LS-174 /190	RC-FT618
LS-175	RC-FT1201
LS-175 /190	RC-FT1201
LS-181	RC-OP1208
LS-181 /190	RC-OP1208
LS-185	RC-DW1201
LS-185 /190	RC-DW1201
LS-186	RC-FD545
LS-186 /190	RC-FD545
LS-188	RC-FT444

CHAMPION	→ NGK
LS-188 /190	RC-FT444
LS-200	RC-VW239
LS-200 /190	RC-VW239
LS-202	RC-VW220
LS-202 /190	RC-VW220
LS-203	RC-AD216
LS-203 /190	RC-AD216
LS-204	RC-ST902
LS-204 /190	RC-ST902
LS-206	RC-MB211
LS-206 /190	RC-MB211
LS-210	RC-BW230
LS-210 /190	RC-BW230
LS-214	RC-BW231
LS-214 /190	RC-BW231
LS-215	RC-BW232
LS-215 /190	RC-BW232
LS-216	RC-BW1101
LS-216 /190	RC-BW1101
LS-222	RC-BW208
LS-222 /190	RC-BW208
LS-224	RC-VW201
LS-224 /190	RC-VW201
LS-225	RC-BW225
LS-225 /190	RC-BW225
LS-226	RC-VW254
LS-226 /190	RC-VW254
LS-227	RC-VW211
LS-227 /190	RC-VW211
LS-232	RC-AD218
LS-232 /190	RC-AD218
LS-233	RC-VW249
LS-233 /190	RC-VW249
LS-238	RC-AD201
LS-238 /190	RC-AD201
LS-25	RC-FD820
LS-25 /190	RC-FD820
LS-27	RC-FD537
LS-27 /190	RC-FD537
LS-28	RC-FD538
LS-28 /190	RC-FD538
LS-30	RC-FD503
LS-30 /190	RC-FD503
LS-301	RC-RN608
LS-301 /190	RC-RN608
LS-306	RC-ZX29
LS-306 /190	RC-ZX29
LS-31	RC-RV603
LS-31 /190	RC-RV603
LS-315	RC-OP421
LS-315 /190	RC-OP421
LS-318	RC-RV303



CHRYSLER		→ NGK
05018 394 AA	RC-CR1203	
J 3242 842	RC-GM1202	
MD 997 629	RC-CR304	

DAIHATSU		→ NGK
19901-87181-000	RC-DE23	
19901-87182-000	RC-DE23	
19901-87183	RC-ED1201	
19901-87183-000	RC-ED1201	
19901-87184-000	RC-DE23	
19901-87186-000	RC-ED1202	
19901-87280-000	RC-DE16	
19901-87281-000	RC-DE16	
19901-87282-000	RC-DE16	
19901-87283-000	RC-DE16	
19901-87285-000	RC-DE16	
19901-87290-000	RC-DE16	
19901-87291-000	RC-DE16	
19901-87295-000	RC-DE16	
19901-87780-000	RC-DE11	
19901-87781-000	RC-ED1203	
19901-87788-000	RC-ED1205	
90048-58273-000	RC-ED1204	
90048-58274-000	RC-ED1204	
90048-66001-000	RC-DE11	
90048-66004-000	RC-DE11	
90048-66014-000	RC-DE11	
90048-87780-000	RC-DE11	
90919-21070-000	RC-TE88	
90919-21118-000	RC-TE86	
90919-21315-000	RC-TE87	

DELCO REMY		→ NGK
DRL 109	RC-AT402	
DRL 111	RC-VW207	
DRL 115	RC-FD509	
DRL 117	RC-RV413	
DRL 125	RC-OP455	
DRL 129	RC-OP419	
DRL 137	RC-VW210	
DRL 140	RC-FD538	
DRL 141	RC-FD537	
DRL 143	RC-FD825	
DRL 145	RC-FD546	
DRL 150	RC-RN637	
DRL 165	RC-FT621	
DRL 166	RC-FT1201	
DRL 176	RC-RV309	
DRL 241	RC-FD544	
DRL 251	RC-OP418	
DRL 257	RC-OP436	

DELCO REMY		→ NGK
DRL 321	RC-VW215	
DRL 350	RC-VW903	
DRL 371	RC-OP1203	
DRL 372	RC-OP440	
DRL 375	RC-OP1208	
DRL 379	RC-RV415	
DRL 382	RC-OP444	
DRL 395	RC-FT1202	
DRL 422	RC-RN603	
DRL 427	RC-CT615	
DRL 451	RC-FT601	
DRL 469	RC-RN623	
DRL 558	RC-VW219	
DRL 574	RC-FD548	
DRL 579	RC-FD808	
DRL 648	RC-DW301	
DRL 649	RC-DW302	
DRL 651	RC-DW304	
DRL 692	RC-FT632	
DRL 699	RC-FT1203	
DRL 701	RC-FD1205	
DRL 757	RC-ET1228	
DRL 800	RC-EF1204	
DRL 876	RC-ET1229	

EUROCABLE		→ NGK
2 101	RC-ST405	
2 108	RC-LD301	
2 503	RC-CT402	
2 509	RC-FT414	
2 751	RC-FT620	
3 600	RC-MB201	
4 000	RC-OP426	
4 004	RC-VX415	
4 008	RC-OP419	
4 012	RC-OP402	
4 013	RC-OP418	
4 015	RC-OP447	
4 016	RC-OP455	
4 027	RC-RV413	
4 032	RC-RV304	
4 034	RC-AT404	
4 042	RC-PG601	
4 048	RC-PG618	
4 053	RC-RN620	
4 054	RC-RN640	
4 061	RC-RV406	
4 062	RC-MX1202	
4 065	RC-RN637	
4 073	RC-SB601	
4 079	RC-RN629	
4 085	RC-RV603	



EUROCABLE	→ NGK
4 088	RC-RV1302
4 099	RC-VL607
4 104	RC-VL616
4 106	RC-RN648
4 117	RC-RN619
4 124	RC-RN655
4 134	RC-ST406
4 149	RC-VW210
4 159	RC-SD401
4 182	RC-VL1301
4 185	RC-VL612
4 198	RC-VL608
4 201	RC-VL611
4 262	RC-VW1102
4 272	RC-VW214
4 276	RC-VW1103
4 302	RC-OP421
4 303	RC-OP412
4 312	RC-OP434
4 318	RC-OP423
4 354	RC-RV303
4 373	RC-CT615
4 381	RC-CT601
4 386	RC-HD408
4 387	RC-HD301
4 388	RC-HD1201
4 400	RC-FT624
4 401	RC-FT608
4 402	RC-FT417
4 403	RC-FT634
4 405	RC-LC606
4 406	RC-FT603
4 407	RC-FT435
4 410	RC-FT618
4 412	RC-FT631
4 413	RC-LC201
4 414	RC-FT621
4 417	RC-FT602
4 418	RC-LC611
4 419	RC-FT628
4 448	RC-CR310
4 462	RC-LC604
4 465	RC-ST403
4 467	RC-FT605
4 471	RC-VW242
4 476	RC-MB218
4 477	RC-MB217
4 485	RC-RV604
4 503	RC-FD825
4 513	RC-VW1101
4 517	RC-RV401
4 555	RC-AR403

EUROCABLE	→ NGK
4 565	RC-LC617
4 580	RC-FD532
4 585	RC-PG605
4 606	RC-FD509
4 628	RC-CT613
4 638	RC-BW231
4 647	RC-CT611
4 653	RC-LC1201
4 663	RC-PG603
4 668	RC-OP427
4 673	RC-FT635
4 700	RC-FD803
4 702	RC-FD804
4 715	RC-OP440
4 738	RC-BW210
4 749	RC-FT601
4 760	RC-AR602
4 761	RC-AR604
4 780	RC-OP408
4 826	RC-FD521
4 829	RC-LC1301
4 857	RC-FD503
4 863	RC-FD538
4 865	RC-FD546
4 889	RC-VW215
4 891	RC-VW220
4 896	RC-AD202
4 908	RC-FT431
4 909	RC-FD537
4 910	RC-OP411
4 915	RC-MX401
4 917	RC-AD1104
4 922	RC-VL609
4 923	RC-PG1301
4 925	RC-PG608
4 926	RC-RV316
4 940	RC-PG602
4 949	RC-CT605
4 954	RC-CT603
4 960	RC-VX402
4 994	RC-CR604
5 501	RC-AD212
5 502	RC-AD216
6 001	RC-OP413
6 003	RC-OP466
6 100	RC-ZE28
6 400	RC-CR304
6 509	RC-FD830
6 516	RC-BW232
6 519	RC-OP459
6 523	RC-FD530
6 527	RC-FD820



EUROCABLE	→ NGK
6 533	RC-MB211
6 534	RC-MB1102
6 545	RC-BW218
6 547	RC-BW230
6 573	RC-BW1101
6 586	RC-MB206
6 592	RC-MB214
6 806	RC-CT412
6 807	RC-OP414
6 850	RC-VW211
6 861	RC-VW223
6 862	RC-VW201
6 909	RC-RN653
6 913	RC-AR603
7 000	RC-AR610
7 001	RC-AR406
7 003	RC-AR907
7 007	RC-AR913
7 031	RC-AD1101
7 099	RC-FT636
7 211	RC-RV313
7 213	RC-RV302
7 215	RC-RV307
7 400	RC-VW219
7 421	RC-SD1201
8 499	RC-RV1207

FACET	→ NGK
4.7059	RC-VL1305
4.7236	RC-HD1205
4.7251	RC-EM1211
4.8347	RC-FT621
4.8349	RC-LC609
4.8351	RC-FT428
4.8354	RC-LC610
4.8357	RC-FT635
4.8359	RC-FT624
4.8366	RC-FT631
4.837	RC-VL606
4.8372	RC-VL606
4.8376	RC-VL614
4.8379	RC-VL616
4.8386	RC-FT435
4.8413	RC-VL611
4.8414	RC-VL608
4.8415	RC-RN655
4.8417	RC-VL609
4.8421	RC-FT446
4.8425	RC-LC617
4.8456	RC-LC612
4.8463	RC-FT431
4.847	RC-VL1301

FACET	→ NGK
4.8470	RC-VL601
4.8472	RC-LD301
4.8491	RC-PG603
4.8493	RC-VW210
4.8494	RC-CR602
4.8496	RC-CR604
4.8499	RC-CT601
4.8503	RC-AR604
4.8509	RC-OP1202
4.851	RC-OP455
4.8511	RC-ST405
4.8516	RC-OP411
4.8518	RC-OP427
4.8527	RC-OP412
4.8528	RC-OP418
4.8537	RC-VL607
4.8539	RC-RN619
4.8547	RC-RN627
4.8548	RC-RN629
4.855	RC-OP204
4.8550	RC-OP204
4.8553	RC-OP466
4.8554	RC-OP426
4.8555	RC-OP430
4.8573	RC-BW210
4.8578	RC-BW223
4.86	RC-BW218
4.8602	RC-BW213
4.8608	RC-NE09
4.8612	RC-ST406
4.8613	RC-FT202
4.8614	RC-FT620
4.8615	RC-FT604
4.8616	RC-FT601
4.8619	RC-ST404
4.8623	RC-AR908
4.8633	RC-ST602
4.8634	RC-OP434
4.8647	RC-AR911
4.865	RC-FT603
4.8654	RC-FT603
4.8655	RC-FT203
4.866	RC-AR201
4.8660	RC-AR201
4.8663	RC-AR912
4.8666	RC-AR205
4.8669	RC-AR913
4.8672	RC-CR602
4.8674	RC-CR601
4.8688	RC-OP438
4.8692	RC-LC611
4.8693	RC-FT605



FACET	→ NGK
4.8694	RC-LC1301
4.87	RC-LC201
4.8700	RC-LC201
4.8705	RC-LC901
4.8708	RC-LC616
4.8719	RC-AR603
4.8727	RC-VW1102
4.8736	RC-VW216
4.8737	RC-VW239
4.8739	RC-VW215
4.8746	RC-PG603
4.8747	RC-PG601
4.8748	RC-CR604
4.8749	RC-PG605
4.8768	RC-AD219
4.8774	RC-AR907
4.8780	RC-CT601
4.8787	RC-AD211
4.8791	RC-AD216
4.8792	RC-AD208
4.8801	RC-RN637
4.8802	RC-RN645
4.8807	RC-FT607
4.8810	RC-VL612
4.8815	RC-FT609
4.8822	RC-FT615
4.8839	RC-RN640
4.8842	RC-LC604
4.8845	RC-LC606
4.8846	RC-PG604
4.8847	RC-FT618
4.8857	RC-FD826
4.8882	RC-FD546
4.8884	RC-ZX29
4.8886	RC-RN602
4.8888	RC-FT628
4.8889	RC-FT602
4.89	RC-BW235
4.8905	RC-BW225
4.891	RC-BW208
4.8917	RC-FT620
4.8923	RC-FD901
4.8934	RC-OP202
4.8966	RC-VW201
4.8967	RC-VW223
4.9001	RC-FT605
4.9024	RC-PG602
4.9025	RC-CT615
4.9035	RC-RN639
4.9038	RC-PG608
4.9040	RC-PG607
4.9043	RC-PG618

FACET	→ NGK
4.9044	RC-CT402
4.9050	RC-RN632
4.9062	RC-FD820
4.9121	RC-RN611
4.9128	RC-RV302
4.9130	RC-RV413
4.9134	RC-VL605
4.9136	RC-SB408
4.9137	RC-SB605
4.9138	RC-SB604
4.9139	RC-SB605
4.914	RC-SB601
4.9142	RC-RN653
4.9149	RC-CT605
4.9184	RC-RV313
4.9185	RC-RV309
4.9189	RC-RV412
4.9194	RC-RV315
4.9237	RC-OP436
4.9293	RC-AD205
4.93	RC-AD1101
4.9301	RC-MB211
4.9305	RC-MB203
4.9306	RC-MB215
4.9307	RC-MB214
4.9308	RC-MB216
4.9316	RC-MB202
4.9317	RC-MB212
4.9318	RC-CT602
4.9319	RC-MB213
4.9323	RC-MB206
4.9332	RC-RN620
4.9343	RC-CR1204
4.935	RC-AR914
4.9353	RC-AD215
4.9361	RC-AR602
4.9363	RC-FT201
4.9365	RC-VW214
4.9367	RC-FT1207
4.9373	RC-SD1201
4.9374	RC-CT615
4.9375	RC-MX401
4.9381	RC-KA1205
4.9385	RC-HD407
4.9392	RC-RV603
4.9401	RC-HD409
4.9443	RC-RN657
4.9445	RC-RN1203
4.9446	RC-RN652
4.9447	RC-RN603
4.9463	RC-VW203
4.9489	RC-AD201



FACET	→ NGK
4.9491	RC-AD1102
4.9492	RC-RN601
4.9501	RC-RN606
4.9503	RC-LC1301
4.9504	RC-FT632
4.9505	RC-FT1203
4.9509	RC-DW1203
4.9516	RC-VW232
4.952	RC-ST902
4.9522	RC-FD530
4.9529	RC-OP1209
4.9531	RC-OP1208
4.9532	RC-OP442
4.9537	RC-VW903
4.9549	RC-VW220
4.9551	RC-VW227
4.9552	RC-VW230
4.9562	RC-OP440
4.957	RC-VW247
4.9575	RC-VW910
4.9585	RC-VW254
4.9591	RC-VW249
4.9601	RC-ST901
4.9608	RC-AR903
4.9619	RC-FD548
4.9624	RC-FD808
4.9625	RC-FD807
4.963	RC-FD546
4.9634	RC-DW304
4.9641	RC-VW219
4.9648	RC-MB1103
4.9649	RC-MB223
4.9667	RC-VW225
4.9672	RC-VW902
4.9681	RC-RN1204
4.9730	RC-DW1204
4.9792	RC-ET1229
4.9831	RC-ET1220
EPS 1.499.059	RC-VL1305
EPS 1.499.236	RC-HD1205
EPS 1.499.251	RC-EM1211
EPS 1.500.347	RC-FT621
EPS 1.500.351	RC-FT428
EPS 1.500.354	RC-LC610
EPS 1.500.357	RC-FT635
EPS 1.500.366	RC-FT631
EPS 1.500.372	RC-VL606
EPS 1.500.376	RC-VL614
EPS 1.500.379	RC-VL616
EPS 1.500.386	RC-FT435
EPS 1.500.415	RC-RN655
EPS 1.500.417	RC-VL609

FACET	→ NGK
EPS 1.500.421	RC-FT446
EPS 1.500.425	RC-LC617
EPS 1.500.456	RC-LC612
EPS 1.500.463	RC-FT431
EPS 1.500.470	RC-VL601
EPS 1.500.472	RC-LD301
EPS 1.500.491	RC-PG603
EPS 1.500.493	RC-VW210
EPS 1.500.494	RC-CR602
EPS 1.500.496	RC-CR604
EPS 1.500.499	RC-CT601
EPS 1.500.503	RC-AR604
EPS 1.500.509	RC-OP1202
EPS 1.500.511	RC-ST405
EPS 1.500.516	RC-OP411
EPS 1.500.527	RC-OP412
EPS 1.500.528	RC-OP418
EPS 1.500.537	RC-VL607
EPS 1.500.539	RC-RN619
EPS 1.500.547	RC-RN627
EPS 1.500.550	RC-OP204
EPS 1.500.554	RC-OP426
EPS 1.500.555	RC-OP430
EPS 1.500.573	RC-BW210
EPS 1.500.578	RC-BW223
EPS 1.500.602	RC-BW213
EPS 1.500.608	RC-NE09
EPS 1.500.612	RC-ST406
EPS 1.500.613	RC-FT202
EPS 1.500.614	RC-FT620
EPS 1.500.615	RC-FT604
EPS 1.500.616	RC-FT601
EPS 1.500.619	RC-ST404
EPS 1.500.623	RC-AR908
EPS 1.500.633	RC-ST602
EPS 1.500.634	RC-OP434
EPS 1.500.647	RC-AR911
EPS 1.500.655	RC-FT203
EPS 1.500.660	RC-AR201
EPS 1.500.663	RC-AR912
EPS 1.500.666	RC-AR205
EPS 1.500.669	RC-AR913
EPS 1.500.674	RC-CR601
EPS 1.500.688	RC-OP438
EPS 1.500.692	RC-LC611
EPS 1.500.693	RC-FT605
EPS 1.500.694	RC-LC1301
EPS 1.500.700	RC-LC201
EPS 1.500.708	RC-LC616
EPS 1.500.727	RC-VW1102
EPS 1.500.736	RC-VW216
EPS 1.500.737	RC-VW239



FACET	→ NGK
EPS 1.500.739	RC-VW215
EPS 1.500.746	RC-PG603
EPS 1.500.747	RC-PG601
EPS 1.500.748	RC-CR604
EPS 1.500.749	RC-PG605
EPS 1.500.768	RC-AD219
EPS 1.500.774	RC-AR907
EPS 1.500.780	RC-CT601
EPS 1.500.787	RC-AD211
EPS 1.500.791	RC-AD216
EPS 1.500.792	RC-AD208
EPS 1.500.801	RC-RN637
EPS 1.500.802	RC-RN645
EPS 1.500.815	RC-FT609
EPS 1.500.839	RC-RN640
EPS 1.500.846	RC-PG604
EPS 1.500.857	RC-FD826
EPS 1.500.884	RC-ZX29
EPS 1.500.888	RC-FT628
EPS 1.500.889	RC-FT602
EPS 1.500.905	RC-BW225
EPS 1.501.001	RC-FT605
EPS 1.501.024	RC-PG602
EPS 1.501.025	RC-CT615
EPS 1.501.038	RC-PG608
EPS 1.501.040	RC-PG607
EPS 1.501.043	RC-PG618
EPS 1.501.044	RC-CT402
EPS 1.501.121	RC-RN611
EPS 1.501.137	RC-SB605
EPS 1.501.138	RC-SB604
EPS 1.501.142	RC-RN653
EPS 1.501.189	RC-RV412
EPS 1.501.237	RC-OP436
EPS 1.501.301	RC-MB211
EPS 1.501.305	RC-MB203
EPS 1.501.306	RC-MB215
EPS 1.501.307	RC-MB214
EPS 1.501.308	RC-MB216
EPS 1.501.316	RC-MB202
EPS 1.501.317	RC-MB212
EPS 1.501.318	RC-CT602
EPS 1.501.319	RC-MB213
EPS 1.501.323	RC-MB206
EPS 1.501.332	RC-RN620
EPS 1.501.343	RC-CR1204
EPS 1.501.353	RC-AD215
EPS 1.501.361	RC-AR602
EPS 1.501.363	RC-FT201
EPS 1.501.365	RC-VW214
EPS 1.501.367	RC-FT1207
EPS 1.501.373	RC-SD1201

FACET	→ NGK
EPS 1.501.374	RC-CT615
EPS 1.501.375	RC-MX401
EPS 1.501.381	RC-KA1205
EPS 1.501.385	RC-HD407
EPS 1.501.401	RC-HD409
EPS 1.501.443	RC-RN657
EPS 1.501.445	RC-RN1203
EPS 1.501.446	RC-RN652
EPS 1.501.447	RC-RN603
EPS 1.501.489	RC-AD201
EPS 1.501.491	RC-AD1102
EPS 1.501.492	RC-RN601
EPS 1.501.501	RC-RN606
EPS 1.501.503	RC-LC1301
EPS 1.501.504	RC-FT632
EPS 1.501.505	RC-FT1203
EPS 1.501.509	RC-DW1203
EPS 1.501.516	RC-VW232
EPS 1.501.522	RC-FD530
EPS 1.501.529	RC-OP1209
EPS 1.501.531	RC-OP1208
EPS 1.501.532	RC-OP442
EPS 1.501.537	RC-VW903
EPS 1.501.549	RC-VW220
EPS 1.501.551	RC-VW227
EPS 1.501.552	RC-VW230
EPS 1.501.562	RC-OP440
EPS 1.501.575	RC-VW910
EPS 1.501.585	RC-VW254
EPS 1.501.601	RC-ST901
EPS 1.501.608	RC-AR903
EPS 1.501.619	RC-FD548
EPS 1.501.624	RC-FD808
EPS 1.501.625	RC-FD807
EPS 1.501.634	RC-DW304
EPS 1.501.641	RC-VW219
EPS 1.501.648	RC-MB1103
EPS 1.501.649	RC-MB223
EPS 1.501.667	RC-VW225
EPS 1.501.672	RC-VW902
EPS 1.501.681	RC-RN1204
EPS 1.501.730	RC-DW1204
EPS 1.501.792	RC-ET1229
EPS 1.501.831	RC-ET1220
FAE	→ NGK
83 020	RC-SB604
83 030	RC-ST601
83 040	RC-LC611
83 100	RC-FT431
83 110	RC-ST406
83 120	RC-PG615



FAE	→ NGK
83 130	RC-CR602
83 140	RC-RN639
83 150	RC-RN619
83 170	RC-RN637
83 180	RC-RN1307
83 190	RC-RN655
83 210	RC-RN1302
83 230	RC-VL616
83 260	RC-LC609
83 310	RC-CT411
83 320	RC-PG603
83 390	RC-FD804
83 400	RC-FD509
83 410	RC-FD530
83 490	RC-OP408
83 510	RC-OP402
83 530	RC-OP411
83 540	RC-OP413
83 560	RC-DW1201
83 561	RC-DW304
83 562	RC-DW301
83 563	RC-DW302
83 564	RC-DW1203
83 570	RC-OP444
83 580	RC-RN602
83 600	RC-CT1304
83 610	RC-CT613
83 630	RC-PG618
83 641	RC-ZX29
83 650	RC-CT601
83 660	RC-AD1104
83 720	RC-VW1102
83 750	RC-AR602
83 760	RC-AR610
83 790	RC-OP430
83 800	RC-OP421
83 820	RC-RV304
83 850	RC-AT405
83 860	RC-RV401
83 870	RC-FT631
83 890	RC-LC614
83 900	RC-FT624
83 910	RC-LC403
83 940	RC-FT636
83 950	RC-AD216
83 970	RC-VW214
83 980	RC-ST902
83 983	RC-CR308
84 485	RC-RN608
85 000	RC-RN653
85 010	RC-CR601
85 050	RC-MB211

FAE	→ NGK
85 060	RC-VW239
85 065	RC-VW218
85 070	RC-VW201
85 080	RC-OP438
85 085	RC-OP304
85 090	RC-OP204
85 105	RC-OP1209
85 110	RC-FD538
85 112	RC-FD544
85 120	RC-FD546
85 125	RC-FD808
85 170	RC-CT412
85 180	RC-PG602
85 190	RC-PG608
85 200	RC-RN620
85 230	RC-RN645
85 250	RC-FT604
85 260	RC-RN601
85 270	RC-FT628
85 280	RC-VW1104
85 290	RC-FT620
85 300	RC-FT608
85 330	RC-RV303
85 360	RC-RV1207
85 370	RC-AT402
85 390	RC-HD408
85 391	RC-HD407
85 401	RC-AR914
85 410	RC-RV313
85 430	RC-VL606
85 450	RC-VL614
85 470	RC-VL609
85 480	RC-VL605
85 481	RC-VL1305
85 490	RC-MB203
85 500	RC-MB214
85 510	RC-MB201
85 520	RC-MB213
85 530	RC-SB605
85 550	RC-SB601
85 560	RC-OP440
85 580	RC-LC1202
85 590	RC-LC1203
85 598	RC-FT444
85 600	RC-CT615
85 610	RC-FT603
85 620	RC-FT618
85 630	RC-LC201
85 640	RC-FT202
85 647	RC-FT632
85 648	RC-FT1203
85 680	RC-AD208



FAE	→ NGK
85 685	RC-VW230
85 690	RC-VW210
85 692	RC-VW208
85 694	RC-VW903
85 695	RC-VW232
85 696	RC-VW910
85 700	RC-FD813
85 710	RC-FD817
85 720	RC-AR908
85 725	RC-AR204
85 740	RC-RV307
85 760	RC-RV413
85 800	RC-RV604
85 810	RC-RV603
85 830	RC-NE09
85 865	RC-VW225
85 870	RC-VW254
85 875	RC-VW203
85 890	RC-BW232
85 900	RC-BW230
85 910	RC-BW218
85 930	RC-BW223
85 940	RC-BW225
85 950	RC-BW208
85 970	RC-DW403
85 990	RC-RN603
85 995	RC-RN652
85 996	RC-RN657
85 997	RC-HD301
85 998	RC-HD1202
85 999	RC-HD1201
86 000	RC-RN606
86 020	RC-CR304
86 040	RC-FT1201
86 050	RC-FT1202

FIAT Group	→ NGK
12 82 38 1	410 080
40 49 77	RC-AR406
43 80 72 2	RC-FT1205
44 57 18 1	RC-ST404
46 40 04 18	RC-AR601
46 42 59 12	RC-FT632
46 42 74 97	RC-FT1207
46 46 91 9	RC-AR903
46 46 92 0	RC-AR903
46 47 48 14	RC-FT1203
46 74 96 24	RC-FT1208
46 75 56 06	RC-AR903
55 19 57 75	RC-FT1209
55 19 57 76	RC-FT1209

FIAT Group	→ NGK
58 88 32 7	RC-FT431
58 88 33 0	RC-FT1205
58 88 33 2	RC-ST404
60 30 60 39	RC-AR602
60 50 42 32	RC-AR403
60 50 43 25	RC-AR403
60 50 48 23	RC-AR403
60 51 30 73	RC-AR912
60 51 34 45	RC-AR913
60 51 34 46	RC-AR913
60 52 29 81	RC-AR610
60 52 30 72	RC-AR912
60 53 47 45	RC-AR907
60 53 47 46	RC-AR907
60 53 48 55	RC-AR201
60 53 78 26	RC-AR911
60 53 79 45	RC-AR911
60 53 79 46	RC-AR911
60 53 84 09	RC-AR911
60 56 64 81	RC-AR908
60 56 64 83	RC-AR908
60 56 95 67	RC-AR610
60 57 30 30	RC-AR201
60 57 37 33	RC-AR205
60 58 41 28	RC-AR403
60 58 41 29	RC-AR602
60 59 09 64	RC-AR906
60 59 73 55	RC-AR204
60 59 79 07	RC-AR914
60 59 79 08	RC-AR914
60 59 79 41	RC-AR914
60 59 79 42	RC-AR914
60 59 79 43	RC-AR204
60 60 07 66	RC-AR906
60 60 60 36	RC-AR602
60 60 60 38	RC-AR602
60 60 98 31	RC-AR917
60 60 98 39	RC-AR917
60 80 05 15	RC-AR603
72 38 55 85	RC-FT418
75 22 46 5	RC-ST404
75 40 53 0	RC-FT442
75 97 20 9	RC-LC607
75 97 72 0	RC-FT638
76 04 90 7	RC-FT435
76 04 97 7	RC-FT435
76 08 77 0	RC-FT603
76 19 33 8	RC-FT428
76 25 94 3	RC-LC612
76 26 75 0	RC-FT624
76 38 48 4	RC-LC1203
76 40 24 5	RC-FT631



FIAT Group	→ NGK
76 55 48 7	RC-LC612
76 61 94 8	RC-FT603
76 63 68 1	RC-FT1206
76 73 21 9	RC-LC610
76 91 32 7	RC-FT621
76 94 36 6	RC-FT607
77 03 38 2	RC-LC201
77 16 09 2	RC-FT609
77 35 10 0	RC-FT202
77 35 39 7	RC-FT203
77 42 00 5	RC-LC1301
77 42 68 9	RC-FT618
77 60 52 3	RC-FT1201
77 76 81 0	RC-FT601
77 85 35 0	RC-FT628
77 87 45 8	RC-LC618
89 68 12 7	RC-LC1205
90 03 84 33	410 070
90 03 84 34	410 060
96 06 71 58 80	RC-LC1203
96 17 23 70 80	RC-CR602

FORD	→ NGK
10 04 427	RC-FD548
10 04 430	RC-FD548
10 04 431	RC-FD548
10 04 432	RC-FD548
10 12 436	RC-FD546
10 18 131	516 100
10 53 905	RC-FD808
10 53 907	RC-FD808
10 53 908	RC-FD808
10 63 605	RC-FD804
10 63 609	RC-FD521
10 63 611	RC-FD520
10 63 613	RC-FD830
10 63 615	RC-FD546
10 63 617	RC-FD537
10 63 619	RC-FD803
10 89 980	RC-FD1205
10 92 379 S	RC-FD808
10 95 589	RC-FD1205
10 95 591	RC-FD1205
10 95 592	RC-FD1205
11 10 740	RC-FD807
11 10 741	RC-FD807
11 10 742	RC-FD807
11 10 743	RC-FD807
11 11 216	RC-FD1212
11 11 218	RC-FD1212
11 11 220	RC-FD1212

FORD	→ NGK
11 11 223	RC-FD1212
11 19 840	RC-FD1207
11 19 841	RC-FD1207
11 19 842	RC-FD1207
11 19 843	RC-FD1207
13 19 060	RC-FD1209
13 19 061	RC-FD1209
13 19 062	RC-FD1209
13 19 063	RC-FD1209
19 53 308	RC-RV303
1S7G-12283-AE	407 040
1S7G-12284-AD	407 050
1S7G-12286-AE	407 020
1S7G-12287-AD	407 060
43 35 033	RC-FD1211
44 54 954	RC-FD1211
51 35 419	RC-FT1209
61 86 107	RC-FD817
65 92 245	RC-FD545
68 28 806	RC-FD1203
68 28 807	RC-FD1203
89SF-12284-AE	RC-FD545
91XF-12284-AC	RC-FD1203
91XF-12286-AC	RC-FD1203
95BF-12284-CA	516 100
A950X-12280-LB	RC-FD546
A970X-12280-AA	RC-FD804
A970X-12280-EA	RC-FD521
A970X-12280-GA	RC-FD520
A970X-12280-JA	RC-FD830
A970X-12280-LA	RC-FD546
A970X-12280-NA	RC-FD537
A970X-12280-QA	RC-FD803
XS6F-12283-B4D	RC-FD1210
XS6F-12284-B4D	RC-FD1210
XS6F-12286-B4D	RC-FD1210
XS6F-12287-B4D	RC-FD1210
YM2A-12283-BA	RC-FD1212
YM2A-12284-BA	RC-FD1212
YM2A-12287-BA	RC-FD1212
YM2F-12286-BA	RC-FD1212

FSO	→ NGK
4 261 590	RC-DW1206
4 451 729	RC-DW1206
5 888 327	RC-DW1206
7 552 293	RC-DW1206
7 589 312	RC-DW1206
7 613 158	RC-DW1206
46 618 703	RC-DW1205
72 168 585	RC-DW1206



FSO	→ NGK
Kager 0054	RC-DW1205
GAZ	→ NGK
MD 997 423	RC-MX1202
GM	→ NGK
12 087 927	RC-DW402
90 104 841	410 050
90 449 677	470 050
90 449 678	470 040
90 461 358	470 060
90 461 360	470 040
90 461 361	469 040
92 060 980	RC-DW1201
96 211 948	RC-DW302
96 256 433	RC-DW304
96 288 956	RC-DW1202
96 305 387	RC-DW301
96 342 284	RC-DW1204
96 450 249	RC-DW1203
NP 1149	RC-DW403
NP 1332	RC-DW401
HELLA	→ NGK
8KA 711 192-001	424 060
8KA 722 186-011	410 040
8KA 722 186-021	410 050
8KA 722 186-031	410 060
8KA 722 186-041	410 070
8KA 722 186-051	410 080
8KA 722 186-061	410 090
8KA 722 187-001	414 030
8KA 722 187-011	414 040
8KA 722 187-021	414 050
8KA 722 187-031	414 060
8KA 722 187-041	414 070
8KA 722 188-001	411 030
8KA 722 188-011	411 040
8KA 722 188-021	411 050
8KA 722 188-031	411 060
8KA 722 188-041	411 070
8KA 722 188-051	411 080
8KA 722 188-061	411 090
8KA 722 189-001	417 030
8KA 722 192-001	424 060
8KA 722 195-001	423 050
8KA 722 195-011	423 060
8KA 722 195-021	423 070
8KA 722 197-001	414 040
8KA 722 197-011	414 050

HELLA	→ NGK
8KA 722 197-021	414 060
8KA 722 197-031	414 070
HONDA	→ NGK
32700-629-000	RC-HE33
32700-689-000	RC-HE33
32700-P0A-A00	RC-HE73
32700-P0D-000	RC-HE80
32700-P0F-000	RC-HE89
32700-P0H-A00	RC-HE73
32700-P14-A00	RC-HE77
32700-P3G-003	RC-HE82
32700-P5L-003	RC-HE82
32700-P5M-003	RC-HE89
32700-P7A-J01	RC-HE76
32700-PA0-000	RC-HE33
32700-PA1-000	RC-HE33
32700-PA1-010	RC-HE33
32700-PA5-000	RC-HE33
32700-PA6-000	RC-HE33
32700-PA6-010	RC-HE33
32700-PAA-A02	RC-HE75
32700-PB1-000	RC-HE33
32700-PB3-000	RC-HE33
32700-PB3-690	RC-HE33
32700-PCB-003	RC-HE89
32700-PDA-E01	RC-HE75
32700-PEJ-004	RC-HE76
32700-PEL-004	RC-HE76
32700-PHK-003	RC-HE82
32700-POD-000	RC-RV1302
32700-POH-A00	RC-HE75
32700-PT0-000	RC-RV1302
32700-TPO-000	RC-RV1302
32701-PR3-010	RC-HE64
32701-PT0-000	RC-HE57
32701-PT0-G00	RC-RV1302
32702-PR3-010	RC-HE64
32702-PT0-000	RC-HE57
32703-PR3-010	RC-HE64
32703-PT0-000	RC-HE57
32704-PR3-010	RC-HE64
32704-PT0-000	RC-HE57
32720-P8A-A02	RC-HE86
32722-P01-G00	RC-HE53
32722-P03-000	RC-RV603
32722-P07-000	RC-HE76
32722-P2A-000	RC-HE73
32722-P2A-003	RC-HE73
32722-P2A-J00	RC-HE73
32722-P2A-J01	RC-HE73
32722-P2F-A03	RC-HE73



HONDA	→ NGK
32722-P2T-000	RC-HE64
32722-P30-000	RC-HE64
32722-P54-000	RC-HE82
32722-P72-003	RC-HE64
32722-P75-A01	RC-HE82
32722-P8A-A02	RC-HE86
32722-PK2-620	RC-EH1202
32722-PM1-B01	RC-HE53
32722-PM3-010	RC-HE53
32722-PM6-B00	RC-HE53
32722-PM7-020	RC-HE81
32722-PM7-B00	RC-HE81
32722-PM7-B01	RC-HE81
32722-PR3-000	RC-HE64
32722-PR3-003	RC-HE64
32722-PV3-000	RC-HE68A
32722-PV4-000	RC-HE90
32723-P1R-000	RC-HE68A
32723-P8A-A01	RC-HE86
32723-PV0-000	RC-HE68A
32723-PV0-J00	RC-HE68A
40294-160-90937	RC-EH1201
HYUNDAI/KIA	→ NGK
7 053 862	RC-FD1208
7 053 866	RC-FD1208
7 262 796	RC-FD1208
7 262 798	RC-FD1208
7 775 810	RC-KA1202
OK201-18140	RC-KA401
OK201-18150	414 050
OK30E-18140	RC-KA1203
OK30F-18140	RC-KA1203
OK558-18140-B	RC-KA1206
OK95H-1814X-A	RC-KA1206
OK9A4-18140-B	RC-KA1205
27400-2X140	RC-KA1203
27420-02610	RC-KA1204
27430-02610	RC-KA1204
27440-02610	RC-KA1204
27450-02610	RC-KA1204
27501-02A00	RC-HD301
27501-02D00	RC-FT444
27501-02H00	RC-KA1204
27501-02W00	RC-KA1204
27501-22B00	RC-FT444
27501-22B10	RC-HD1202
27501-23A00	RC-HD407
27501-23B70	RC-HD407
27501-24B10	RC-HD408
27501-32C00	RC-HD411
27501-32F00	RC-HD1203

HYUNDAI/KIA	→ NGK
27501-33A00	RC-HD1201
27501-35B00	RC-HD404
27501-37B00	RC-HD1205
27501-38B00	RC-HD1204
90919-21357	RC-HD1203
90919-21364	RC-HD1203
90919-21428	RC-HD1203
OK247-18160-A	RC-KA1201
OK247-18180-A	RC-KA1201
ISUZU	→ NGK
5-86000-666-0	RC-HE57
5-86004-641-0	RC-HE71
5-86004-642-0	RC-HE76
5-86007-725-0	RC-HE80
5-86009-109-0	RC-HE73
5-86009-667-0	RC-HE73
5-86009-668-0	RC-HE73
8-94208-921-0	RC-IE42
8-94209-306-0	RC-IE42
8-94221-954-0	RC-IE42
8-94232-770-0	RC-IE42
JAKOPARTS	→ NGK
J538 3026	RC-ZX49
JANMOR	→ NGK
JP 200	RC-EM1211
JP 226	RC-ET1229
JEEP	→ NGK
833 00 155	RC-CR310
J3242 842	RC-GM1202
LADA	→ NGK
5888 327	RC-FT431
2121 371 7080	RC-LD1205
21214 370 7080	RC-LD1203
2108 370 7080 10	RC-LD1201
2108 370 7080 11	RC-LD1201
LAND ROVER	→ NGK
GHT 291	RC-RV1202
RTC 6551	RC-RV309
LUCAS	→ NGK
103	450 100
DHB 112	410 030



LUCAS	→ NGK
DHB 116	410 040
DHB 120	410 050
DHB 124	410 060
DHB 128	410 070
DHB 132	410 080
DHB 136	410 090
DHB 312	414 030
DHB 316	414 040
DHB 328	414 070
DHB 412	411 030
DHB 416	411 040
DHB 420	411 050
DHB 424	411 060
DHB 428	411 070
DHB 432	411 080
DHB 436	411 090
DHB 511	417 030
DHB 750	414 040
DHB 755	424 060
DHB 770	423 050
DHB 912	414 040
DHB 916	414 050
DHB 920	414 060
DHB 924	414 070
DHB 931	410 030
DHB 933	414 040
DHB 941	410 040
DHB 943	414 050
DHB 951	410 050
DHB 953	414 060
DHB 961	410 060
DHB 963	414 070
DHB 971	410 060
DHB 981	410 080
DHB 991	410 090
DHC 131	210 030
DHC 141	210 040
DHC 142	211 040
DHC 143	214 040
DHC 144	215 040
DHC 151	210 050
DHC 161	210 060
DHC 162	211 060
DHC 172	211 070
DHC 182	211 080
DHC 219	221 120
DHC 229	221 130
DHC 276	RC-MB211
DHC 286	RC-MB207
DKB 100	RC-OP426
DKB 101	RC-OP418
DKB 103	RC-OP447

LUCAS	→ NGK
DKB 104	RC-OP423
DKB 105	RC-OP411
DKB 106	RC-OP412
DKB 107	RC-OP459
DKB 108	RC-OP427
DKB 109	RC-FD537
DKB 111	RC-FD803
DKB 112	RC-CT611
DKB 113	RC-CT603
DKB 114	RC-CT605
DKB 115	RC-SB601
DKB 116	RC-VL612
DKB 117	RC-VL1301
DKB 118	RC-VL611
DKB 119	RC-RN640
DKB 120	RC-VL616
DKB 121	RC-VL607
DKB 124	RC-ST405
DKB 125	RC-MX401
DKB 126	RC-FD825
DKB 127	RC-AT402
DKB 128	RC-AR403
DKB 129	RC-AR604
DKB 130	RC-FT621
DKB 131	RC-CR601
DKB 132	RC-PG602
DKB 133	RC-RN629
DKB 135	RC-CT615
DKB 136	RC-FT604
DKB 137	RC-PG615
DKB 138	RC-PG608
DKB 141	RC-AT405
DKB 142	RC-OP466
DKB 144	RC-ST601
DKB 145	RC-OP455
DKB 146	RC-OP419
DKB 147	RC-FD538
DKB 150	RC-FD521
DKB 151	RC-RV413
DKB 152	RC-RV603
DKB 153	RC-RV604
DKB 154	RC-RV304
DKB 157	RC-RV605
DKB 158	RC-VX415
DKB 159	RC-OP402
DKB 160	RC-PG603
DKB 163	RC-JG1201
DKB 166	RC-FT628
DKB 167	RC-AR406
DKB 168	RC-AR610
DKB 169	RC-CT602
DKB 170	RC-LC617



LUCAS	→ NGK
DKB 171	RC-FT631
DKB 172	RC-FT435
DKB 173	RC-LC609
DKB 174	RC-FT420
DKB 175	RC-FT417
DKB 176	RC-ST404
DKB 177	RC-OP413
DKB 180	RC-LC614
DKB 181	RC-LC607
DKB 183	RC-FD530
DKB 184	RC-FD830
DKB 185	RC-FD820
DKB 186	RC-JG1202
DKB 187	RC-RV406
DKB 188	RC-OP414
DKB 189	RC-FD804
DKB 190	RC-RN409
DKB 191	RC-FT624
DKB 192	RC-FD532
DKB 193	RC-LC610
DKB 199	RC-CT601
DKB 200	RC-CT613
DKB 201	RC-CR604
DKB 202	RC-CT402
DKB 204	RC-CT411
DKB 205	RC-PG616
DKB 206	RC-SB601
DKB 207	RC-VL608
DKB 210	RC-LD302
DKB 211	RC-LD301
DKB 212	RC-SD401
DKB 213	RC-FD509
DKB 214	RC-AT404
DKB 223	RC-FT634
DKB 224	RC-FT609
DKB 225	RC-FD546
DKB 226	RC-FD503
DKB 228	RC-LC604
DKB 229	RC-FT605
DKB 231	RC-OP421
DKB 232	RC-RN637
DKB 233	RC-RN627
DKB 234	RC-RN619
DKB 235	RC-RN655
DKB 237	RC-RV307
DKB 242	RC-FT620
DKB 243	RC-FD536
DKB 244	RC-RV1302
DKB 248	RC-RV303
DKB 249	RC-OP463
DKB 251	RC-RV1204
DKB 252	RC-VL605

LUCAS	→ NGK
DKB 255	RC-FD1201
DKB 256	RC-FD1202
DKB 258	RC-OP408
DKB 259	RC-HD409
DKB 260	RC-HD409
DKB 261	RC-HD1201
DKB 263	RC-SD1201
DKB 264	RC-FT601
DKB 266	RC-RV322
DKB 269	RC-FD1203
DKB 276	RC-PG617
DKB 277	RC-RV318
DKB 278	RC-RV415
DKB 279	RC-FT1202
DKB 280	RC-FT618
DKB 283	RC-FT1201
DKB 284	RC-FT1201
DKB 285	RC-LC1201
DKB 290	RC-ST403
DKB 291	RC-FT603
DKB 292	RC-AR603
DKB 293	RC-LC201
DKB 294	RC-LC1301
DKB 297	RC-AR602
DKB 298	RC-AR907
DKB 301	RC-FT442
DKB 302	RC-FT428
DKB 303	RC-FT446
DKB 304	RC-FT431
DKB 306	RC-FT414
DKB 309	RC-FT636
DKB 310	RC-LC611
DKB 311	RC-FT608
DKB 312	RC-FT635
DKB 314	RC-FT638
DKB 323	RC-FD545
DKB 324	RC-FD544
DKB 326	RC-HD301
DKB 327	RC-HD408
DKB 329	RC-CR310
DKB 331	RC-KA401
DKB 332	RC-MX1202
DKB 333	RC-RN606
DKB 335	RC-RN653
DKB 338	RC-RN653
DKB 339	RC-RN620
DKB 340	RC-RV404
DKB 341	RC-RV401
DKB 342	RC-FT607
DKB 344	RC-RN648
DKB 345	RC-FD1204
DKB 346	RC-ZE28



LUCAS	→ NGK
DKB 381	RC-RV323
DKB 382	RC-RV309
DKB 385	RC-CT412
DKB 386	RC-FD508
DKB 387	RC-AR414
DKB 388	RC-RV1207
DKB 390	RC-MX1201
DKB 394	RC-RN623
DKB 397	RC-RN645
DKB 398	RC-PG1301
DKB 399	RC-OP434
DKB 400	RC-OP430
DKB 401	RC-OP432
DKB 402	RC-OP1208
DKB 403	RC-OP436
DKB 404	RC-RV316
DKB 405	RC-RV313
DKB 408	RC-FD817
DKB 410	RC-PG601
DKB 415	RC-JG1203
DKB 416	RC-FD807
DKB 417	RC-FD808
DKB 418	RC-FD824
DKB 424	RC-FT444
DKB 425	RC-RV412
DKB 426	RC-RV302
DKB 427	RC-RV301
DKB 428	RC-RV414
DKB 431	RC-RV1202
DKB 432	RC-RV1205
DKB 433	RC-RV1203
DKB 438	RC-HD407
DKB 445	RC-KA402
DKB 447	RC-ST406
DKB 448	RC-VX1201
DKB 449	RC-FT602
DKB 450	RC-ZX29
DKB 451	RC-RN608
DKB 452	RC-OP1209
DKB 453	RC-RV410
DKB 454	RC-SB408
DKB 455	RC-RN603
DKB 456	RC-FD826
DKB 458	RC-SB605
DKB 459	RC-VL609
DKB 460	RC-VL606
DKB 461	RC-VL1302
DKB 462	RC-VL604
DKB 464	RC-FD548
DKB 465	RC-CT615
DKB 467	RC-RV303
DKB 468	RC-OP440

LUCAS	→ NGK
DKB 469	RC-OP438
DKB 470	RC-RN601
DKB 471	RC-RN652
DKB 473	RC-FT1203
DKB 474	RC-RN658
DKB 475	RC-RN611
DKB 477	RC-FD1205
DKB 478	RC-RV1201
DKB 479	RC-DW1201
DKB 480	RC-DW403
DKB 484	RC-RN1203
DKB 485	RC-OP304
DKB 558	RC-MB217
DKB 585	RC-AR903
DKB 602	RC-RV1301
DKB 603	RC-FT632
DKB 605	RC-OP448
DKB 631	RC-CR306
DKB 632	RC-CR304
DKB 633	RC-CR309
DKB 634	RC-FT615
DKB 635	RC-LC403
DKB 636	RC-FD533
DKB 637	RC-LC606
DKB 638	RC-VX402
DKB 639	RC-LC612
DKB 640	RC-PG406
DKB 641	RC-LC406
DKB 643	RC-LC615
DKB 644	RC-PG618
DKB 645	RC-FT415
DKB 646	RC-DW301
DKB 647	RC-HD411
DKB 648	RC-PG605
DKB 649	RC-RN639
DKB 651	RC-RV308
DKB 652	RC-DW302
DKB 653	RC-DW304
DKB 654	RC-RV1206
DKB 655	RC-RV305
DKB 656	RC-OP453
DKB 659	RC-SB604
DKB 660	RC-VL614
DKB 662	RC-OP204
DKB 664	RC-OP444
DKB 665	RC-OP306
DKB 668	RC-RN650
DKB 671	RC-OP203
DKB 672	RC-OP450
DKB 674	RC-JG1204
DKB 677	RC-OP1201
DKB 681	RC-OP301



LUCAS	→ NGK
DKB 682	RC-VW217
DKB 685	RC-RN649
DKB 687	RC-OP403
DKB 692	RC-HD404
DKB 698	RC-LC616
DKB 699	RC-RN646
DKB 703	RC-FD519
DKB 706	RC-AR601
DKB 707	RC-RN632
DKB 710	RC-RN1301
DKB 712	RC-RN1302
DKB 714	RC-PG612
DKB 718	RC-OP465
DKB 723	RC-LC1202
DKB 724	RC-LC1203
DKB 725	RC-OP1202
DKB 726	RC-RN602
DKB 727	RC-RV315
DKB 731	RC-RN651
DKB 732	RC-OP442
DKB 733	RC-ST602
DKB 735	RC-VL613
DKB 736	RC-JG1205
DKB 737	RC-KA404
DKB 738	RC-CR305
DKB 739	RC-CR308
DKB 740	RC-CR606
DKB 741	RC-CR602
DKB 742	RC-CT405
DKB 743	RC-CT406
DKB 744	RC-CT612
DKB 745	RC-PG609
DKB 746	RC-DW401
DKB 747	RC-DW402
DKB 748	RC-FT418
DKB 749	RC-FT454
DKB 750	RC-FD520
DKB 751	RC-FD813
DKB 752	RC-CR301
DKB 753	RC-CR302
DKB 754	RC-LC618
DKB 755	RC-FT633
DKB 756	RC-OP307
DKB 757	RC-OP458
DKB 758	RC-CT601
DKB 759	RC-PG604
DKB 760	RC-PG607
DKB 761	RC-PG611
DKB 762	RC-RN657
DKB 763	RC-RV901
DKB 764	RC-SB406
DKB 765	RC-RN1306

LUCAS	→ NGK
DKB 766	RC-SD402
DKB 767	RC-VL601
DKB 768	RC-VL602
DKB 772	RC-OP1203
DKC 100	RC-VW1101
DKC 101	RC-VW215
DKC 102	RC-AD216
DKC 103	RC-BW230
DKC 104	RC-BW218
DKC 105	RC-BW1101
DKC 106	RC-AD1101
DKC 107	RC-MB1102
DKC 108	RC-AD212
DKC 109	RC-MB211
DKC 110	RC-VW210
DKC 111	RC-MB218
DKC 112	RC-VW1102
DKC 113	RC-VW214
DKC 114	RC-VW242
DKC 116	RC-ST902
DKC 117	RC-BW210
DKC 118	RC-BW232
DKC 119	RC-MB209
DKC 120	RC-BW231
DKC 124	RC-AR913
DKC 125	RC-AR908
DKC 128	RC-VW219
DKC 133	RC-VW209
DKC 137	RC-VW207
DKC 141	RC-VW239
DKC 142	RC-VW220
DKC 143	RC-VW206
DKC 147	RC-VW208
DKC 148	RC-AD205
DKC 152	RC-MB213
DKC 154	RC-BW213
DKC 155	RC-BW223
DKC 157	RC-MB214
DKC 158	RC-MB212
DKC 164	RC-VW211
DKC 165	RC-MB201
DKC 166	RC-VW254
DKC 169	RC-VW223
DKC 170	RC-VW201
DKC 172	RC-VW230
DKC 173	RC-AD202
DKC 174	RC-AD1101
DKC 175	RC-VW912
DKC 176	RC-VW225
DKC 177	RC-BW208
DKC 178	RC-VW905
DKC 179	RC-FT202



LUCAS	→ NGK
DKC 180	RC-MB203
DKC 181	RC-VW902
DKC 182	RC-VW232
DKC 183	RC-VW910
DKC 201	RC-MB206
DKC 202	RC-AD211
DKC 203	RC-VW1103
DKC 204	RC-VW1104
DKC 205	RC-AD1104
DKC 206	RC-AD209
DKC 207	RC-MB1102
DKC 208	RC-MB208
DKC 209	RC-AR906
DKC 211	RC-PS1101
DKC 212	RC-AR911
DKC 213	RC-FT203
DKC 214	RC-AR912
DKC 215	RC-LC901
DKC 216	RC-AR204
DKC 217	RC-MB219
DKC 218	RC-AR914
DKC 219	RC-AR205
DKC 220	RC-AR201
DKC 221	RC-AD208
DKC 222	RC-AD201
DKC 223	RC-AR901
DKC 224	RC-AR917
DKC 225	RC-AD206
DKC 226	RC-AD207
DKC 227	RC-AD210
DKC 228	RC-AD1101
DKC 229	RC-AD218
DKC 230	RC-AD219
DKC 231	RC-VW218
DKC 232	RC-VW236
DKC 233	RC-BW205
DKC 235	RC-BW225
DKC 236	RC-BW233
DKC 237	RC-BW235
DKC 238	RC-FT201
DKC 239	RC-FD901
DKC 240	RC-LC1301
DKC 241	RC-MB202
DKC 242	RC-MB222
DKC 243	RC-MB207
DKC 244	RC-MB215
DKC 245	RC-MB220
DKC 246	RC-MB223
DKC 247	RC-MB225
DKC 248	RC-OP201
DKC 249	RC-OP202
DKC 250	RC-ST204

LUCAS	→ NGK
DKC 251	RC-ST901
DKC 252	RC-AD1102
DKC 253	RC-VW203
DKC 254	RC-VW246
DKC 255	RC-VW247
DKC 256	RC-VW249
DKC 257	RC-ST201
DKC 258	RC-VW216
DKC 259	RC-VW227
DKC 260	RC-VW233
DKC 261	RC-VW235
DKC 262	RC-VW235
DKC 263	RC-VW249
DKC 264	RC-VW235
DKC 265	RC-VW244
DKC 266	RC-VW249
DKC 267	RC-VW903
DKC 268	RC-VW904
DKC 269	RC-VW907
DKC 270	RC-MB216
DKC 271	RC-AD215
MAZDA	→ NGK
7613158	408 060
0000-18-094A	RC-ZE94A
0000-18-097B	RC-ZE97A
0000-18-098A	RC-ZE98
0000-18-099A	RC-ZX99A
0000-18-101A	RC-ME51
0000-18-102A	RC-ZE07
0000-18-103A	RC-ZE06
0000-18-118A	RC-ZX18
0000-18-119A	RC-ZX19
0000-18-121A	RC-ZE21
0000-18-125A	RC-ZE25
0000-18-128A	RC-ZE28
0000-18-130A	RC-ZE30
0000-18-132B	RC-ZE32B
0000-18-136A	RC-ZE36
0000-18-137A	RC-ZE37
0000-18-149A	RC-ZX49
0000-18-152A	RC-ZX52
0000-18-153A	RC-ZE53
1393-18-140A	RC-ZE94A
1410-18-140	RC-ZE94A
1N01-18-140	RC-NE08
1N02-18-140	RC-NE08
1N03-18-140	RC-NX11
290-18-140	RC-ZE94A
4094-18-140	RC-ZE94A
4094-18-140A	RC-ZE94A



MAZDA	→ NGK
4113-18-140	RC-ZE94A
4113-18-140A	RC-ZE94A
501-18-140A	RC-ZE37
8248-18-150A	RC-ZE97A
8254-18-140	RC-ZE94A
8562-18-150A	RC-ZE97A
8574-18-140	RC-ZE94A
8AB2-18-140	RC-ZX19
8AU3-18-140	RC-ZE17
8B6P-18-140T	RC-EZ1209
8BB1-18-140	RC-ZE08
8BB2-18-140	RC-ZE11
8BB4-18-140A	RC-ZE08
8BB7-18-140	RC-ZE08
8BB8-18-140A	RC-ZE07
8BB8-18-140B	RC-ZE07
8BBG-18-140	RC-ZE08
8BBG-18-240	RC-ZX19
8BBL-18-140B	RC-ZX18
8BBR-18-140	RC-ZX19
8BBS-18-140	RC-ZX18
8BE1-18-140B	RC-ZX18
8BF1-18-140A	RC-ZE30
8BG6-18-140	RC-ZX14
8BG8-18-140	RC-ZX14
8BG9-18-140	RC-ZX15
8BG9-18-140A	RC-ZX15
8BGA-18-140	RC-ZX16
8BGA-18-140A	RC-ZX16
8BGG-18-140A	RC-ZX14
8BGH-18-140A	RC-ZX14
8BGJ-18-140A	RC-ZX15
8BGL-18-140	RC-ZX15
8BGP-18-140A	RC-ZE31
8BGP-18-140B	RC-ZE31
8BH3-18-140	RC-ZE06
8BH3-18-140B	RC-ZE06
8BH3-18-140C	RC-ZE06
8BH4-18-140	RC-ZX49
8BH8-18-140	RC-ZX49
8BL3-18-140	RC-ZE06
8BU5-18-140	RC-ZE17
8BU5-18-140A	RC-ZE17
B31R-18-140	RC-ZE23
B33G-18-140A	RC-EZ1210
B34M-18-140	RC-ZE23
B3C7-18-140B	RC-ZE23
B3M5-18-140	RC-EZ1210
B61P-18-140C	RC-ZE21
B6BF-18-140A	RC-ZE36
B6BF-18-140B	RC-ZE36
B6MC-18-140B	RC-ZE21

MAZDA	→ NGK
BPE-18-140A	RC-ZE21
BPE8-18-140A	RC-ZE21
E303-18-140D	RC-ZE98
F801-18-140A	RC-ZX99A
F8R9-18-140	RC-ZX15
FE65-89-182	RC-ZX99A
FE85-89-182	RC-ZX99A
FEED-18-150	RC-ZX15
FP13-18-140A	RC-ZX49
FP39-18-140	RC-ZX52
FP85-18-140A	RC-EZ1201
FP86-18-140A	RC-EZ1201
H612-18-140	RC-ZE94A
KF01-18-150B	RC-ZE31
KF33-18-140D	RC-EZ1209
KL47-18-140C	RC-ZE32B
N3A1-18-140	RC-ZE30
N3H1-18-140A	RC-EZ1216
N3H1-18-140B	RC-EZ1216
N3R1-18-140	RC-EZ1216
N3R1-18-140A	RC-EZ1216
Z501-18-140	RC-ZE37
Z501-18-140A	RC-ZE37
Z520-18-140B	RC-ZE37
ZE08-18-140	RC-ZE94A
ZE23-18-140	RC-ZE23
ZE28-18-140	RC-ZE28
ZE31-18-140	RC-EZ1209
ZE98-18-140	RC-ZE98
ZL01-18-140A	RC-ZE53
ZX09-18-140	RC-EZ1208
ZX15-18-140	RC-ZX15
ZX16-18-140	RC-ZX16
ZX19-18-140	RC-ZX19
ZX29-18-140	RC-ZX49
MERCEDES	→ NGK
A 102 150 19 18	RC-MB1105
A 102 150 20 18	RC-MB1105
A 102 150 21 18	RC-MB1105
A 102 150 28 18	RC-MB1105
A 102 150 29 18	RC-MB207
A 102 150 54 18	245 060
A 102 150 55 18	245 070
A 102 150 56 18	245 090
A 110 150 14 18	RC-MB206
A 110 150 40 18	RC-MB208
A 110 150 46 18	RC-MB206
A 110 150 63 18	RC-MB1102
A 110 150 69 18	RC-MB1102
A 110 150 70 18	RC-MB1102



MERCEDES	→ NGK
A 110 150 71 18	RC-MB1102
A 110 150 72 18	RC-MB1102
A 110 150 73 18	RC-MB1102
A 110 150 74 18	RC-MB1102
A 112 150 01 18	RC-MB223
A 112 150 02 18	RC-MB223
A 112 150 03 18	RC-MB1103
A 112 150 04 18	RC-MB1103
A 116 150 12 19	RC-MB216
A 116 150 13 19	RC-MB216
A 266 150 02 18	RC-MB1106
A 266 150 06 18	RC-MB1106
A 266 150 07 18	RC-MB1106
MITSUBISHI	→ NGK
MD 002 960	RC-ME54
MD 008 115	RC-ME51
MD 010 179	RC-ME54
MD 013 028	RC-ME54
MD 021 757	RC-ME51
MD 021 758	RC-ME51
MD 021 766	RC-ME51
MD 023 742	RC-ME51
MD 025 733	RC-ME51
MD 025 734	RC-ME51
MD 026 710	RC-ME51
MD 026 711	RC-ME51
MD 030 838	RC-EM1206
MD 030 899	RC-EM1206
MD 030 901	RC-ME54
MD 030 938	RC-ME54
MD 041 673	RC-ME51
MD 041 721	RC-ME51
MD 073 771	RC-ME54
MD 075 865	RC-ME51
MD 080 570	RC-ME54
MD 084 318	RC-ME54
MD 085 765	RC-ME51
MD 134 754	RC-ME64
MD 143 880	RC-ME74
MD 156 560	RC-ME78
MD 180 171	RC-ME74
MD 192 925	RC-ME64
MD 192 995	RC-ME64
MD 193 015	RC-ME79
MD 193 980	RC-ME78
MD 195 228	RC-ME77
MD 311 208	RC-ME95
MD 321 461	RC-EM1211
MD 332 100	RC-ME111
MD 332 110	RC-ME111

MITSUBISHI	→ NGK
MD 334 017	RC-ME79
MD 334 021	RC-ME79
MD 334 041	RC-ME109
MD 334 043	RC-ME96
MD 338 249	RC-ME94
MD 338 624	RC-ME96
MD 343 245	RC-EM1211
MD 346 850	RC-ME78
MD 362 276	RC-EM1201
MD 365 102	RC-EM1202
MD 976 524	RC-ME61
MD 977 423	RC-EM1203
MD 997 328	RC-ME59
MD 997 378	RC-EM1207
MD 997 422	RC-EM1206
MD 997 424	RC-ME59
MD 997 629	RC-CR304
MOSKVICH	→ NGK
2140 370 7088	RC-MX1205
21412 370 7050	RC-MX1205
MOTORCRAFT	→ NGK
EWR	RC-FD521
EWR 1 E	RC-FD804
EWR 10 E	RC-FD538
EWR 11	RC-FD546
EWR 11 E	RC-FD546
EWR 13 E	RC-FD537
EWR 15 E	RC-FD803
EWR 17 E	RC-FD826
EWR 6 E	RC-FD825
EWR 7 E	RC-FD520
EWR 9 E	RC-FD830
NIPPARTS	→ NGK
J 538 0306	RC-KA1203
J 538 0307	RC-KA1206
J 538 0310	RC-HD1204
J 538 0508	RC-HD1203
J 538 0509	RC-HD1205
J 538 0511	RC-KA1204
J 538 0512	RC-HD1202
J 538 1014	RC-EN1206
J 538 1015	RC-NE08
J 538 2080	RC-ET1219
J 538 3006	RC-ZE17
J 538 4000	RC-EH1202
J 538 4018	RC-HE86
J 538 5012	RC-ME111



NIPPARTS	→ NGK
J 539 0004	RC-ED1205
NISSAN	→ NGK
22440-0M802	RC-NX11
22440-0M810	RC-NX11
22440-0M811	RC-NX11
22440-0M815	RC-NX11
22440-0U000	RC-NE09
22440-0U010	RC-NE09
22440-1N510	RC-NX11
22440-2J210	RC-NX11
22440-41B02	RC-NE09
22440-41B11	RC-NE09
22440-42L00	RC-NX81A
22440-42L10	RC-NX81A
22440-53Y11	RC-NE08
22440-57Y10	RC-NE08
22440-5U000	RC-NX11
22440-71L00	RC-NX81A
22440-71L10	RC-NX81A
22440-72B00	RC-NE09
22440-99B00	RC-NE09
22440-99B05	RC-NE09
22440-99B06	RC-NE09
22440-AN200	RC-NE09
22450-01A25	RC-NX71
22450-01A26	RC-NX71
22450-01B26	RC-NX71
22450-01M25	RC-NX71
22450-01R25	RC-NX71
22450-01W51	RC-EN1210
22450-03A25	RC-NX71
22450-03P27	RC-NE77A
22450-05A26	RC-NX71
22450-05L25	RC-NE61
22450-05L26	RC-NE61
22450-05L27	RC-NE61
22450-0E028	RC-NX07
22450-11M25	RC-NX71
22450-13P25	RC-NE77A
22450-14S25	RC-NE61
22450-15A25	RC-NX71
22450-15A26	RC-NX71
22450-15A27	RC-NX71
22450-15A28	RC-NX71
22450-15A85	RC-NX71
22450-15M25	RC-NX71
22450-15R25	RC-EN1204
22450-21F26	RC-EN1204
22450-24C25	RC-NX25
22450-26E26	RC-NE77A

NISSAN	→ NGK
22450-34A25	RC-NX71
22450-37J25	RC-NE29
22450-42L50	RC-NX81A
22450-43L25	RC-NE77A
22450-43L26	RC-NE77A
22450-53A25	RC-NX71
22450-53J28	RC-NX07
22450-54C27	RC-NX07
22450-56A25	RC-NX71
22450-56S25	RC-NX81A
22450-65E25	RC-NX93
22450-74Y26	RC-EN1203
22450-77A25	RC-NX89
22450-78A25	RC-NX89
22450-84A25	RC-NX89
22450-85E25	RC-NX91
22450-86G26	RC-NX93
22450-88G25	RC-EN1206
22450-89J26	RC-EN1201
22450-D1127	RC-EN1204
22450-D3526	RC-NE64
22450-F5125	RC-NE61
22450-F5900	RC-NE61
22450-F5910	RC-NE61
22450-F5925	RC-NE61
22450-F6025	RC-NE77A
22450-G1625	RC-NE66
22450-H5051	RC-NE66
22450-H5060	RC-NE66
22450-H5061	RC-NE66
22450-M2225	RC-NE66
22450-N4425	RC-NE61
22450-P6525	RC-NE61
22450-R5825	RC-NE61
22450-R5826	RC-NE61
22450-R6525	RC-NE61
22450-U7826	RC-NE61
22450-V0325	RC-NE61
22450-V5200	RC-NE77A
22450-V5225	RC-NE77A
22450-V6503	RC-NE77A
22450-Y4025	RC-NE61
22450-Y4026	RC-NE61
22450-Y4027	RC-NE61
22450-Y4525	RC-NE61
22450-Y4526	RC-NE61
22450-Y6425	RC-NE61
22450-Y6426	RC-NE61
OPEL	→ NGK
08 968 125	414 050
08 968 127	410 050



OPEL	→ NGK
08 968 128	410 040
08 968 129	410 030
08 968 130	410 070
08 968 132	410 060
09 286 769	414 050
12 073 944	419 050
90 007 104	RC-OP301
90 008 240	RC-OP408
90 009 357	RC-OP427
90 038 432	410 070
90 038 433	410 070
90 038 434	410 060
90 102 025	410 070
90 102 297	410 090
90 102 303	410 050
90 104 841	410 050
90 113 025	RC-OP402
90 119 482	414 070
90 123 090	410 070
90 123 091	410 040
90 123 092	410 060
90 197 194	RC-OP1217
90 213 570	418 075
90 225 541	419 070
90 225 542	419 070
90 225 543	RC-OP1217
90 225 544	RC-OP1217
90 243 828	418 075
90 243 829	418 075
90 275 397	419 070
90 276 528	410 040
90 295 495	RC-OP426
90 297 570	RC-OP455
90 337 002	451 050
90 337 012	450 100
90 337 019	450 050
90 337 743	451 050
90 337 744	451 030
90 349 318	RC-OP1212
90 349 319	RC-OP447
90 349 320	RC-OP411
90 350 549	RC-OP1214
90 350 554	RC-OP418
90 350 564	RC-OP413
90 350 565	RC-OP204
90 350 566	RC-OP203
90 350 567	RC-OP202
90 357 614	451 050
90 357 919	RC-OP1217
90 392 649	RC-OP414
90 421 759	RC-OP418
90 442 064	RC-OP412

OPEL	→ NGK
90 442 404	RC-OP463
90 443 584	RC-OP201
90 443 691	RC-OP432
90 443 692	RC-OP1213
90 443 693	RC-OP1219
90 443 694	RC-OP430
90 449 677	470 050
90 449 678	470 040
90 461 358	470 060
90 461 360	470 040
90 461 361	469 040
90 486 281	RC-OP466
90 486 612	RC-OP434
90 487 569	RC-OP434
90 487 571	RC-OP440
90 491 944	RC-OP1206
90 492 169	470 060
90 492 170	470 060
90 492 171	470 040
90 492 172	470 040
90 493 032	RC-OP1206
90 506 765	RC-OP450
90 507 989	RC-OP450
90 507 990	RC-OP450
90 510 379	RC-OP450
90 510 851	RC-OP304
90 510 852	RC-OP453
90 510 853	RC-OP1218
90 510 854	RC-OP442
90 510 855	RC-OP448
90 510 857	RC-OP444
90 510 858	RC-OP1209
90 542 968	RC-OP1209
90 543 259	RC-OP1101
90 543 260	RC-OP1101
90 543 261	RC-OP1101
90 543 262	RC-OP1101
92 061 881	RC-OP1216
92 061 882	RC-OP1216
92 061 883	RC-OP1216
92 061 884	RC-OP1216
93 176 699	RC-OP1211
93 176 701	RC-OP1208
93 176 703	RC-OP1211
93 186 089	RC-OP434
94 433 364	RC-OP1215
12 82 000	470 050
12 82 001	470 040
12 82 011	RC-OP1204
12 82 013	418 075
12 82 017	419 070
12 82 019	RC-OP1217



OPEL	→ NGK
12 82 020	RC-OP1217
12 82 021	419 070
12 82 030	410 040
12 82 032	RC-OP1204
12 82 033	419 050
12 82 044	451 030
12 82 045	RC-OP1209
12 82 046	451 050
12 82 064	419 070
12 82 070	451 050
12 82 074	RC-OP1217
12 82 084	470 050
12 82 086	470 040
12 82 087	469 040
12 82 103	470 060
12 82 107	470 060
12 82 117	470 060
12 82 118	470 040
12 82 119	470 040
12 82 120	470 060
12 82 142	RC-OP1216
12 82 143	RC-OP1216
12 82 144	RC-OP1216
12 82 145	RC-OP1216
12 82 146	RC-OP438
12 82 147	RC-OP438
12 82 153	RC-OP1101
12 82 154	RC-OP1101
12 82 155	RC-OP1101
12 82 156	RC-OP1101
12 82 344	414 060
12 82 374	410 060
12 82 376	414 050
12 82 378	410 040
12 82 379	410 030
12 82 380	410 090
12 82 381	410 070
12 82 386	410 050
12 82 387	410 070
12 82 393	410 070
12 82 394	410 060
12 82 395	410 050
12 82 396	410 040
12 82 398	410 070
12 82 399	410 070
12 82 400	410 060
12 82 408	414 070
12 82 409	RC-OP1217
12 82 434	450 050
12 82 435	451 050
12 82 439	450 100
12 82 578	418 075

OPEL	→ NGK
12 82 580	418 075
12 821 46N	RC-OP438
12 821 47N	RC-OP438
12 823 77E	410 050
12 825 78E	418 075
12 825 80E	418 075
16 12 429	RC-OP402
16 12 434	RC-OP1202
16 12 456	RC-OP301
16 12 458	RC-OP408
16 12 462	RC-OP427
16 12 473	RC-OP426
16 12 476	RC-OP459
16 12 479	RC-OP455
16 12 483	RC-OP1212
16 12 484	RC-OP447
16 12 485	RC-OP411
16 12 492	RC-OP421
16 12 497	RC-OP412
16 12 498	RC-OP418
16 12 503	RC-OP1214
16 12 505	RC-OP202
16 12 506	RC-OP203
16 12 507	RC-OP204
16 12 508	RC-OP413
16 12 509	RC-OP419
16 12 522	RC-OP466
16 12 525	RC-OP414
16 12 528	RC-OP463
16 12 530	RC-OP418
16 12 531	RC-OP412
16 12 533	RC-OP419
16 12 543	RC-OP463
16 12 552	RC-OP201
16 12 557	RC-OP432
16 12 558	RC-OP1213
16 12 559	RC-OP1219
16 12 560	RC-OP430
16 12 561	RC-OP1101
16 12 585	RC-OP466
16 12 591	RC-OP434
16 12 592	RC-OP434
16 12 597	RC-OP434
16 12 598	RC-OP440
16 12 602	RC-OP450
16 12 603	RC-OP1206
16 12 605	RC-OP450
16 12 606	RC-OP444
16 12 607	RC-OP1209
16 12 608	RC-OP304
16 12 609	RC-OP453
16 12 610	RC-OP1218



OPEL	→ NGK
16 12 611	RC-OP442
16 12 612	RC-OP448
16 12 619	RC-OP1206
16 12 622	RC-OP450
16 12 623	RC-OP450
16 12 630	RC-OP1205
16 12 631	RC-OP1205
16 12 639	RC-OP1209
16 12 648	RC-OP1201
16 12 651	RC-OP434
16 12 655	RC-OP1211
16 12 657	RC-OP1208
16 12 659	RC-OP1211
16 125 12E	RC-OP423
43 00 014	RC-OP1210
43 01 718	RC-OP1215
48 83 233	RC-CR1202
PORSCHE	→ NGK
477 998 031	RC-PS1103
PSA	→ NGK
75 491 868	RC-CT1301
75 524 946	RC-CT1301
95 493 437	RC-CT406
95 495 940	RC-CT402
95 495 963	RC-CT406
95 561 517	RC-CT1304
95 581 882	RC-CT402
95 584 562	RC-CT402
95 605 678	RC-CT612
95 607 320	RC-CT613
95 636 601	RC-CT611
95 636 605	RC-CT611
95 659 595	RC-CT605
95 659 598	RC-CR604
96 061 817	RC-PG609
96 066 677	RC-PG609
97 533 275	RC-CT613
97 535 465	RC-PG602
5967.E5	RC-CR604
14 621 100 80	RC-PG617
55 02 135	RC-CT1301
5967.A6	RC-PG605
5967.C2	RC-PG603
5967.C3	RC-CT411
5967.H2	RC-CT412
5967.H4	RC-PG609
5967.H5	RC-CR604
5967.J7	RC-PG604

PSA	→ NGK
5967.J9	RC-PG607
5967.K3	RC-PG603
5967.K4	RC-CR604
5967.K6	RC-CT601
5967.K7	RC-CT411
5967.K9	RC-PG615
5967.K0	RC-PG605
5967.L0	RC-PG617
5967.L2	RC-PG602
5967.L3	RC-CR602
5967.L4	RC-PG608
5967.L5	RC-CT615
5967.L6	RC-CR602
5967.L7	RC-PG617
5967.L8	RC-CR602
5967.L9	RC-CT615
5967.N1	RC-CR602
5967.N6	RC-CT615
77 008 548 24	RC-PG618
91 537 676 80	RC-PG1302
91 537 756 80	RC-CT601
96 088 851 80	RC-CR602
96 094 933 80	RC-PG617
GX 061 230 1C	RC-CT1304
RENAULT	→ NGK
11 01 349 467	RC-RN1305
60 25 003 095	RC-RN619
74 31 275 284	RC-RN608
74 31 335 874	RC-VL605
74 39 135 700	RC-VL605
77 00 102 225	RC-RN602
77 00 106 221	RC-RN606
77 00 107 662	RC-RN603
77 00 114 549	RC-RN1204
77 00 267 668	RC-RN1301
77 00 268 919	RC-RN650
77 00 273 226	RC-RN1203
77 00 529 568	RC-RN1201
77 00 590 752	RC-RN1302
77 00 646 235	RC-RN1306
77 00 720 781	RC-RN1307
77 00 720 783	RC-RN611
77 00 726 626	RC-RN619
77 00 741 025	RC-VL1302
77 00 742 835	RC-RN637
77 00 742 837	RC-RN645
77 00 745 285	RC-RN1307
77 00 749 521	RC-RN620
77 00 850 463	RC-RN619
77 00 850 470	RC-VL607
77 00 855 768	RC-VL616



RENAULT	→ NGK
77 00 856 896	RC-RN653
77 00 857 981	775 090
77 00 859 069	RC-RN602
77 00 866 923	RC-RN652
77 00 874 109	RC-RN603
77 00 874 564	RC-RN601
77 01 025 483	RC-RN1305
77 01 348 929	RC-CT603

ROVER	→ NGK
32700-POD-000	RC-RV1302
32700-PT0-000	RC-RV1302
32700-TPO-000	RC-RV1302
32701-PT0-G00	RC-RV1302
ETC 8618	RC-AR414
GHT 208	RC-RV316
GHT 249	RC-RV316
GHT 252	RC-RV413
GHT 254	RC-RV604
GHT 257	RC-RV307
GHT 258	RC-RV605
GHT 261	RC-RV413
GHT 263	RC-RV304
GHT 264	RC-RV412
GHT 265	RC-RV313
GHT 270	RC-RV303
GHT 271	RC-RV313
GHT 272	RC-RV302
GHT 280	RC-RV318
GHT 282	RC-RV303
GHT 283	RC-RV301
GHT 284	RC-RV415
GHT 285	RC-RV308
GHT 287	RC-RV414
GHT 288	RC-RV305
GHT 289	RC-RV410
GHT 291	RC-RV1205
GHT 293	RC-AT405
NGC 104 250	RC-RV901
STC 8656	RC-AR414

SAAB	→ NGK
88 17 314	RC-SB605
88 17 520	RC-SB605
88 21 951	RC-SB408
93 37 346	RC-SB601

SUBARU	→ NGK
22450-AA050	414 030
22450-AA070	414 030
22450-AA090	RC-FE25
22450-AA111	RC-EF1202

SUBARU	→ NGK
22450-KA050	RC-FE30
22451-AA010	RC-FE25
22451-AA030	411 100
22451-AA031	RC-EF1202
22451-AA040	411 040
22451-AA060	411 030
22451-AA071	411 100
22451-AA080	411 100
22451-AA100	411 090
22451-AA120	RC-FX54
22451-AA130	RC-EF1204
22451-AA231	RC-EF1202
22451-AA241	RC-FX31
22451-AA261	RC-FX31
22451-AA410	RC-FX31
22451-AA420	RC-FX31
22451-AA450	RC-FE39
22451-AA511	RC-FX49
22451-AA543	RC-EF1204
22451-AA580	RC-FX54
22451-AA590	RC-EF1204
22451-AA600	RC-EF1204
22451-AA620	RC-EF1204
22451-AA630	RC-EF1201
22451-AA640	RC-EF1201
22451-AA660	RC-FX67
22451-AA661	RC-FX67
22451-AA710	RC-FX67
22451-AA793	RC-FX51
22451-AA890	RC-FX67
22451-KA000	411 060
22451-KA151	RC-FE30
22451-KA361	RC-FE65
22452-AA010	RC-FE25
22452-AA090	RC-FE39
22452-AA112	RC-FX49
22452-KA002	411 050
22452-KA121	RC-FE30
22452-KA371	RC-FE65
22453-AA010	RC-FE25
22453-KA002	411 050
22453-KA061	RC-FE30
22453-KA291	RC-FE65
22454-AA010	RC-FE25
22454-AA090	RC-FE39
22454-KA191	RC-FE65
42077-7100	RC-FE22
42077-7200	RC-FE22
42077-7800	RC-FE22
42077-7900	RC-FE22
49722-7000	RC-FE22



SUZUKI	→ NGK
33700-51G10-000	RC-ES1201
33700-56B20-A00	RC-SE94
33700-60A20	RC-SE83
33700-63810	RC-SE83
33700-82010	RC-ES1201
33700-82011	RC-ES1206
33700-86010	RC-SE77
33700-86020	RC-SE77
33705-64B10	RC-SE82
33705-66D00	RC-SE17
33705-71C20	RC-SE02
33705-75F02	RC-SE13
33705-75F03	RC-SE13
33705-80040	RC-ES1202
33705-83020	RC-SE95
33710-57B20	RC-SE14
33710-58B20	RC-SE94
33710-63B30	RC-ES1201
33710-64B10	RC-SE82
33710-75F00	RC-SE13

TESLA	→ NGK
T 295 P	RC-EM1211

TOYOTA	→ NGK
72 385 585	RC-ET1204
19037-62010	RC-TE66
19037-75010	RC-ET1229
27501-32F00	RC-HD1203
90080-91127	RC-ET1217
90919-15208	RC-ET1214
90919-15209	RC-ET1214
90919-15211	RC-ET1214
90919-15317	RC-TE79
90919-15417	RC-TE66
90919-15418	RC-TE66
90919-15419	RC-TE66
90919-15456	RC-TE79
90919-15457	RC-TE79
90919-15490	RC-TE79
90919-15491	RC-TE79
90919-15492	RC-TE79
90919-15510	RC-TE41
90919-15511	RC-TE41
90919-15512	RC-TE41
90919-15513	RC-TE41
90919-21064	RC-TE81
90919-21067	RC-TE81
90919-21070	RC-TE88
90919-21098	RC-TE81
90919-21099	RC-TE81

TOYOTA	→ NGK
90919-21101	RC-TE86
90919-21113	RC-TE88
90919-21118	RC-TE86
90919-21120	RC-TE86
90919-21142	RC-TE88
90919-21148-9	RC-TX71
90919-21153	RC-TE86
90919-21156	RC-TE93
90919-21164	RC-TE86
90919-21174	RC-TE87
90919-21177	RC-TE94
90919-21188	RC-TE86
90919-21217	RC-TE93
90919-21235	RC-TE88
90919-21254	RC-TE95
90919-21259	RC-TE87
90919-21261	RC-TE81
90919-21265	RC-TE94
90919-21268	RC-TE93
90919-21270	RC-TE94
90919-21287	RC-TE86
90919-21298	RC-TE83
90919-21301	RC-ET1220
90919-21304	RC-TE81
90919-21307	RC-TE87
90919-21308	RC-TE87
90919-21315	RC-TE87
90919-21316	RC-TX05
90919-21319	RC-TE88
90919-21322	RC-ET1212
90919-21324	RC-ET1211
90919-21327	RC-ET1203
90919-21338	RC-TE81
90919-21357	RC-HD1203
90919-21364	RC-HD1203
90919-21370	RC-TX06
90919-21373	RC-ET1210
90919-21377	RC-TE87
90919-21395	RC-ET1210
90919-21398	RC-TE88
90919-21400	RC-ET1219
90919-21401	RC-ET1210
90919-21404	RC-TE25
90919-21405	RC-TE25
90919-21417	RC-ET1208
90919-21428	RC-HD1203
90919-21431	RC-TX99A
90919-21461	RC-ET1221
90919-21468	RC-ET1219
90919-21470	RC-TE25
90919-21473	RC-ET1219
90919-21489	RC-TX71

NGK RESISTOR PLUG COVERS

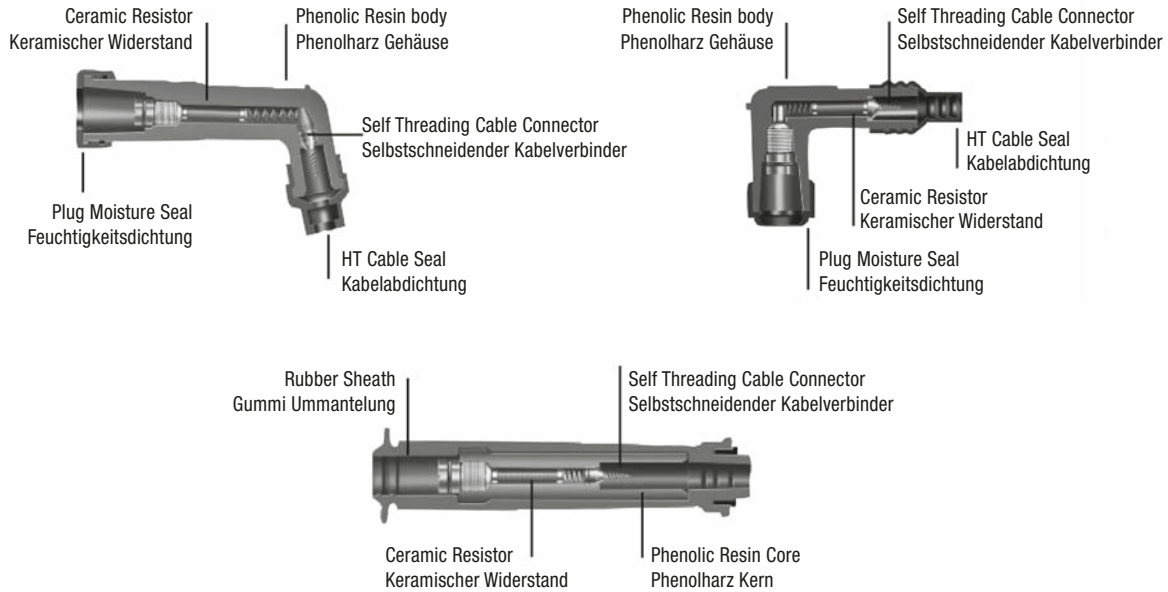



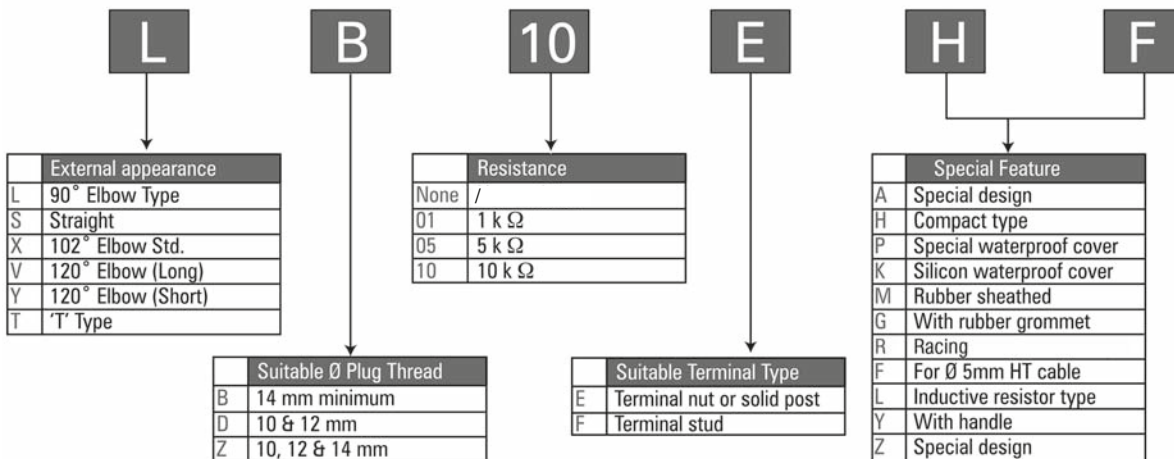

COVER SYMBOLS EXPLANATION CHART

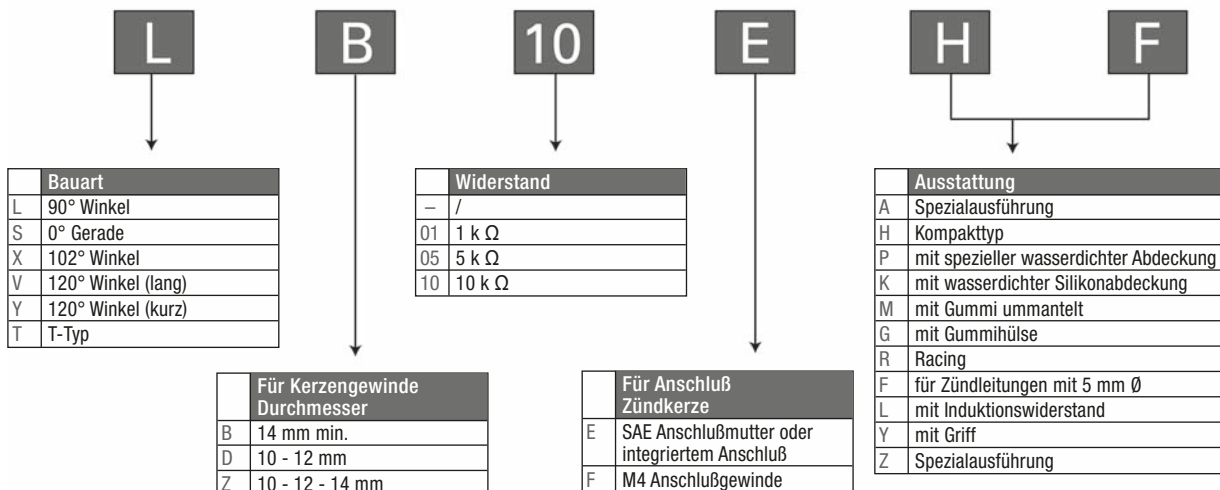



ERKLÄRUNG DER KURZZEICHEN

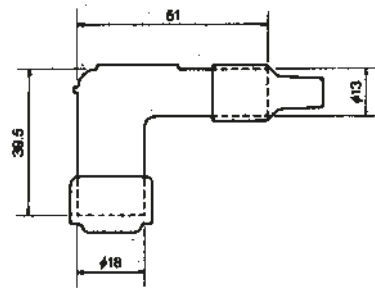

Basic	Type	Stock-No.	Colour	R [kΩ]	Ø [mm]	Terminal
LB	LB - E	8302	black	/	14	
	LB01E	8011	black	1		
	LB05E - R	8898	red	5		
	LB05E	8031	black	5		
	LB10E	8349	black	10		
	LB - F	8309	black	/		
	LB01F	8330	black	1		
	LB01FF	8331	black	1		
	LB05F	8051	black	5		
	LB05F - R	8854	red	5		
	LB05FF	30326	black	5		
	LB10F	8358	black	10		
	LB10FF	8359	black	10		
LD	LD05E	6902	black	5	10-12	
	LD - F	8311	black	/		
	LD01F	8362	black	1		
	LD05F - R	8231	red	5		
	LD05F	8060	black	5		
	LD10F	8997	black	10		

Phenolic Resin







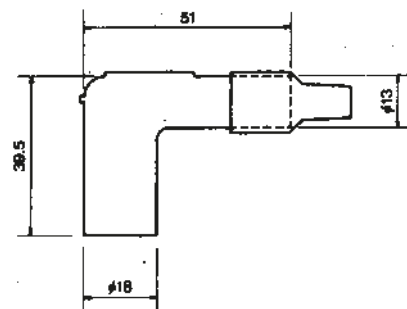

Basic	Type	Stock-No.	Colour	R [kΩ]	Ø [mm]	Terminal
LB	LB01EP	8328	black	1	14	
	LB05EP	8020	black	5		
	LB - EPK	8304	black	/		
	LB05EPK	8342	black	5		
	LB01FP	8088	black	1		
	LB05FP	8030	black	5		
LD	LD05FP	8070	black	5	10 - 12	

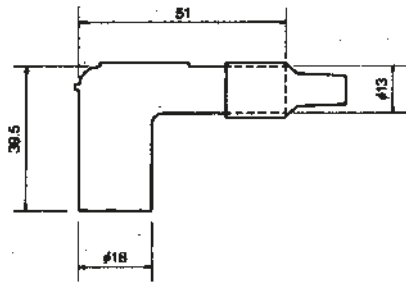

Phenolic Resin



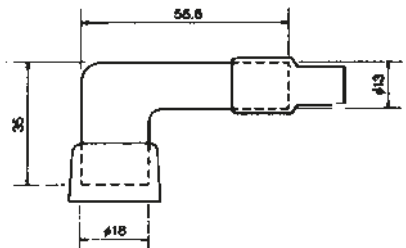

Basic	Type	Stock-No.	Colour	R [kΩ]	 Ø [mm]	Terminal
LZ	LZ05F	8368	black	5	10-12-14	
Phenolic Resin						
						

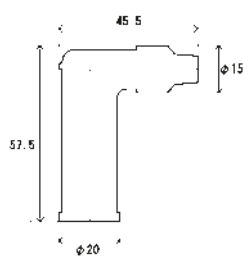

Basic	Type	Stock-No.	Colour	R [kΩ]	 Ø [mm]	Terminal
LB	LB05FG	8346	black	5	14	
Phenolic Resin						
						
						



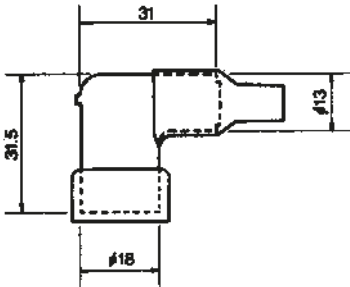

Basic	Type	Stock-No.	Colour	R [kΩ]	 Ø [mm]	Terminal
LB	LB05EZ	8744	black	5	14	
Phenolic Resin						
						
						

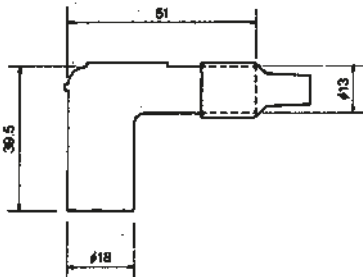

Basic	Type	Stock-No.	Colour	R [kΩ]	 Ø [mm]	Terminal
L	L05EA	6667	black	5		
Phenolic Resin						
						
						



Basic	Type	Stock-No.	Colour	R [kΩ]	Ø [mm]	Terminal
L	L - EH	8301	black	/		
Phenolic Resin						
						

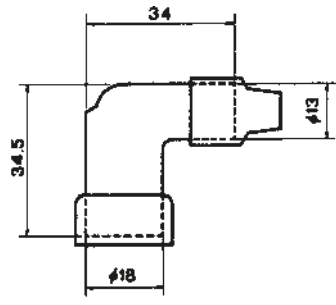

Basic	Type	Stock-No.	Colour	R [kΩ]	Ø [mm]	Terminal
LB	LB01EH	8326	black	1	14	
	LB01EHF	8327	black	1		
	LB05EH	8334	black	5		
	LB05EHF	8336	black	5		
	LB10EH	8351	black	10		
	LB10EHF	8055	black	10		
	LB - FH	8310	black	/		
LD	LD - FH	8313	black	/	10-12	
Phenolic Resin						
 						

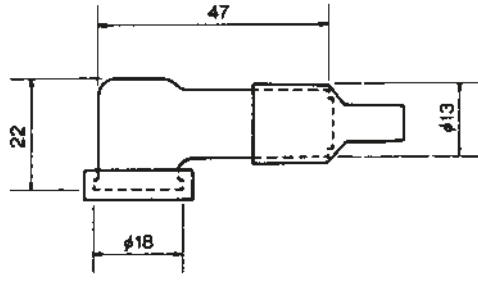

Basic	Type	Stock-No.	Colour	R [kΩ]	Ø [mm]	Terminal
LB	LB10EHAH	8719	black	10	14	
Phenolic Resin						
 						

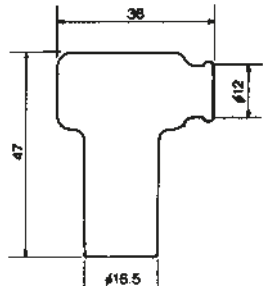

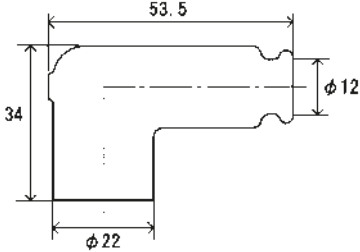

Basic	Type	Stock-No.	Colour	R [kΩ]	 Ø [mm]	Terminal
LZ	LZEH	8760	black	/	10-12-14	
	LZFH	8710	black	/		
Phenolic Resin						
						

Basic	Type	Stock-No.	Colour	R [kΩ]	 CM6	Terminal
LC	LC05EFK	8050	black	5		
Phenolic Resin						
						

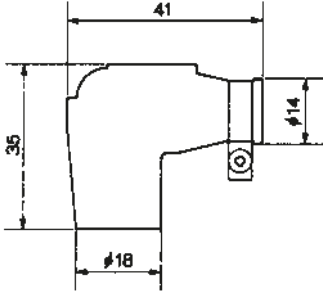
Basic	Type	Stock-No.	Colour	R [kΩ]	 Ø [mm]	Terminal
LB	LB05EMH	8338	black	5	14	
	LB05EMH - R	8160	red	5		
Rubber sheathed						
						

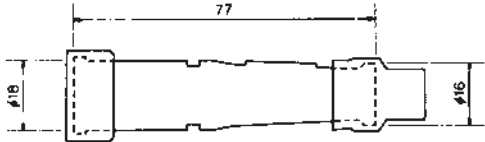

Basic	Type	Stock-No.	Colour	R [kΩ]	Ø [mm]	Terminal
LB	LB05EMHA	8549	red	5	14	
Rubber sheathed						
						

Basic	Type	Stock-No.	Colour	R [kΩ]	Ø [mm]	Terminal
LB	LBER - B	8308	blue	/	14	
Silikon Rubber						
						

Basic	Type	Stock-No.	Colour	R [kΩ]	Ø [mm]	Terminal
SB	SB01E	8370	black	1	14	
	SB05E	8374	black	5		
	SB10E	8803	black	10		
	SB01F	8372	black	1		
	SB05F	8080	black	5		
	SB05F - R	8567	red	5		
	SB10F	8387	black	10		
SD	SD05E	6894	black	5	10-12	
	SD01F	8388	black	1		
	SD05F	8022	black	5		
	SD05F - R	8238	red	5		
	SD10F	8394	black	10		
SZ	SZ05F	8396	black	5	10-12-14	
Phenolic Resin						
						

Basic	Type	Stock-No.	Colour	R [kΩ]	Ø [mm]	Terminal
SB	SB05FP	8386	black	5	14	
SD	SD05FP	8325	black	5	10 - 12	
Phenolic Resin						
						

Basic	Type	Stock-No.	Colour	R [kΩ]	Ø [mm]	Terminal
SD	SD05EG	5818	black	5	10-12	
Phenolic Resin						
						

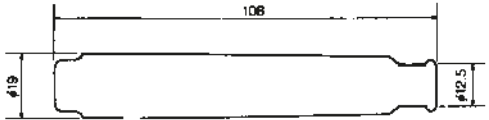
Basic	Type	Stock-No.	Colour	R [kΩ]	Ø [mm]	Terminal
SD	SD05FM	8392	black	5	10-12	
	SD05FM - R	8673	red	5		
Rubber sheathed						
 						

Basic	Type	Stock-No.	Colour	R [kΩ]	Ø [mm]	Terminal
SD	SD05FGA	8683	black	5	10-12	
Phenolic Resin						
						
<p>Application: Honda VT 600, XL 600</p>						

Basic	Type	Stock-No.	Colour	R [kΩ]	Ø [mm]	Terminal
VB	VB01E	8405	black	1	14	
	VB05E	8408	black	5		
	VB - F	8913	black	/		
	VB01F	8406	black	1		
	VB05F	8032	black	5		
	VB05F - R	8759	red	5		
	VB10F	8414	black	10		
VD	VD01F	8415	black	1	10-12	
	VD05F	8052	black	5		
	VD05F - R	8376	red	5		
	VD10F	8430	black	10		

Phenolic Resin

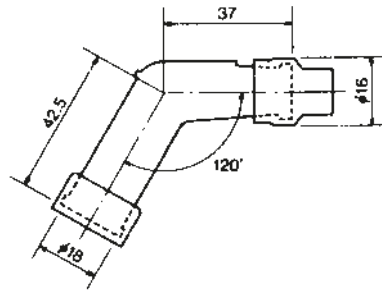

Basic	Type	Stock-No.	Colour	R [kΩ]	Ø [mm]	Terminal
VB	VB05FP	8413	black	5	14	



Phenolic Resin





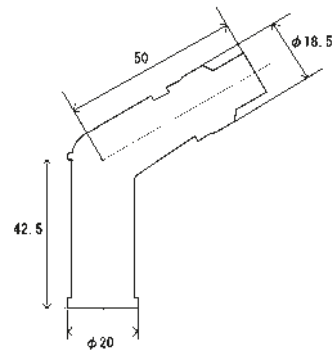

Basic	Type	Stock-No.	Colour	R [kΩ]	Ø [mm]	Terminal
V	V05E	6665	black	5		



Phenolic Resin

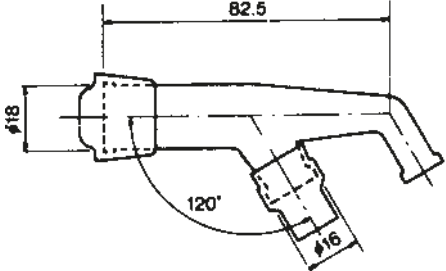

Basic	Type	Stock-No.	Colour	R [kΩ]	Ø [mm]	Terminal
VD	VD05EG	5817	black	5	10-12	
Phenolic Resin						
						

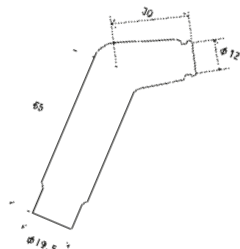
Basic	Type	Stock-No.	Colour	R [kΩ]	Ø [mm]	Terminal
VB	VB05EYK	8411	black	5	14	
Phenolic Resin						
 						

Basic	Type	Stock-No.	Colour	R [kΩ]	Ø [mm]	Terminal
VD	VD05EM	8422	black	5	10-12	
Rubber sheathed						
 						

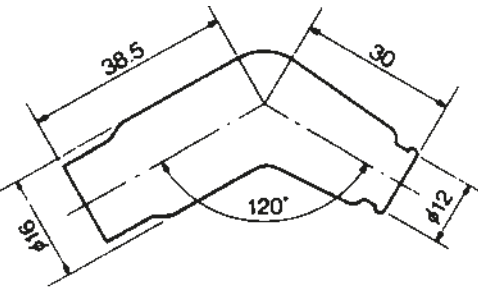
Basic	Type	Stock-No.	Colour	R [kΩ]	Ø [mm]	Terminal
VD	VD05EMH	7744	black	5	10-12	
	VD05FMH	8425	black	5		
Rubber sheathed						
 						

Basic	Type	Stock-No.	Colour	R [kΩ]	Ø [mm]	Terminal
VD	VD05FML	8427	black	5	10-12	
Rubber sheathed						



Basic	Type	Stock-No.	Colour	R [kΩ]	Ø [mm]	Terminal
YB	YB01F	8446	black	1	14	
	YB05F	8082	black	5		
	YB05F	8162	red	5		
	YB10F	8449	black	10		
YD	YD01F	8450	black	1	10-12	
	YD05F	8454	black	5		
	YD05F	8453	red	5		
Phenolic Resin						

Basic	Type	Stock-No.	Colour	R [kΩ]	Ø [mm]	Terminal
XB	XB01F	8431	black	1	14	
	XB05F	8062	black	5		
	XB05F - R	8592	red	5		
	XB10F	8436	black	10		
XD	XD01F	8439	black	1	10-12	
	XD05F	8072	black	5		
	XD05F - R	8768	red	5		
	XD10F	8442	black	10		
XZ	XZ01F	8443	black	1	10-12-14	
	XZ05F	8444	black	5		
Phenolic Resin						

Basic	Type	Stock-No.	Colour	R [kΩ]	 Ø [mm]	Terminal
XB	XB05FP	8435	black	5	14	
XD	XD05FP	8641	black	5	10 - 12	



Phenolic Resin



Basic	Type	Stock-No.	Colour	R [kΩ]	 Ø [mm]	Terminal
TB	TB05EM - R	8955	red	5	14	
	TB10EM - Y	8404	yellow	10		

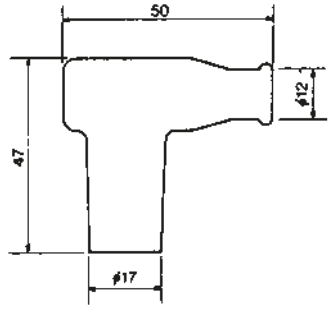

Rubber sheathed





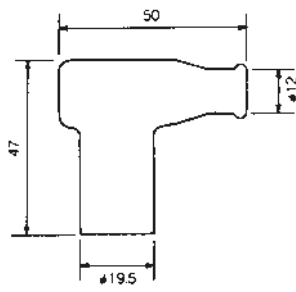

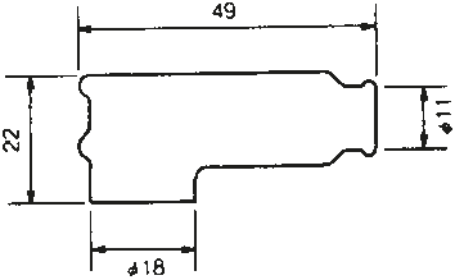

Basic	Type	Stock-No.	Colour	R [kΩ]	 Ø [mm]	Terminal
TB	TB05EMA	8636	black	5	14	

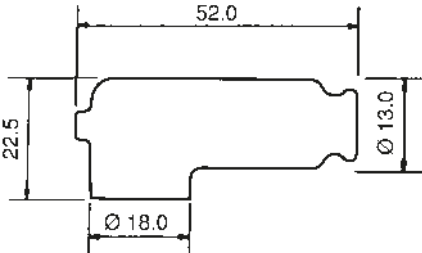

Rubber sheathed



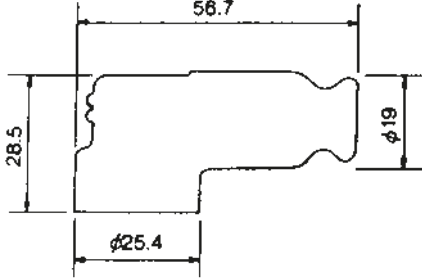

Basic	Type	Stock-No.	Colour	R [kΩ]		Terminal
TB	TRS1225 - B	8787	blue	5	R6120 A/C/M R7282 A/C/M	
<p>Rubber sheathed</p>  						

Basic	Type	Stock-No.	Colour	R [kΩ]		Terminal
TB	TRS1233A - R	8929	red	5	R6120 A/C/M R7282 A/C/M	
	TRS1233B - Y	8897	yellow	5		
	TRS1233C - G	8546	green	5		
<p>Rubber sheathed</p>  						

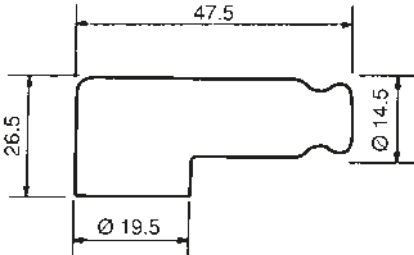
Basic	Type	Stock-No.	Colour	R [kΩ]		Terminal
TB	TRS1408F - B	8871	blue	5	R5300A R5300N	
<p>Rubber sheathed</p>  						

Basic	Type	Stock-No.	Colour	R [kΩ]		Terminal
TB	TRS1409 - R	8733	red	5	R5540F	
<p>Rubber sheathed</p>  						



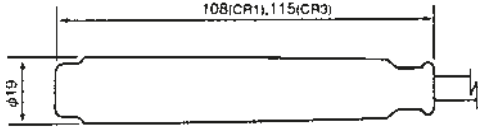

Basic	Type	Stock-No.	Colour	R [kΩ]	Ø [mm]	Terminal
CR	CR1	8035	red	5	10-12-14	
	CR3	8089	red	5		

Rubber sheathed





red
500 mm

CR1: SD05FM CR3: SD05EMK

Basic	Type	Stock-No.	Colour	R [kΩ]	Ø [mm]	Terminal
CR	CR2	8048	red	5	10-12-14	
	CR4	8054	red	5		
	CR5	8515	red	5		
	CR6	8736	red	5		

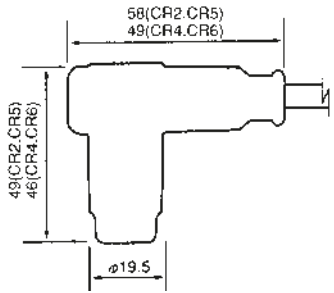
Rubber sheathed





red
500 mm
red
1000 mm

CR2: LZ05FM CR4: TB05EMA
CR5: LZ05FM CR6: TB05EMA

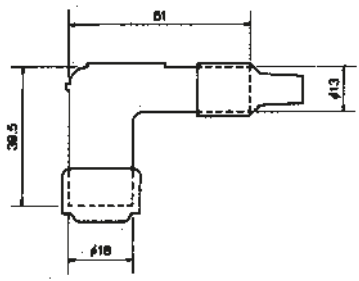

Basic	Type	Stock-No.	Colour	R [kΩ]	Ø [mm]	Terminal
	LY11	8718	red	5	10-12-14	



Phenolic Resin





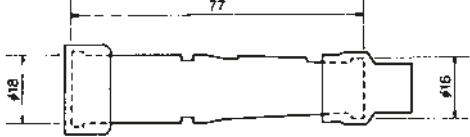

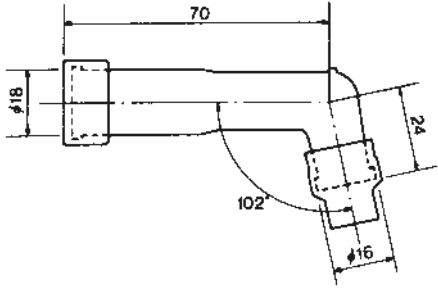

yellow
500 mm

LZ05F

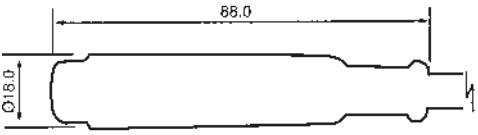
Basic	Type	Stock-No.	Colour	R [kΩ]	Ø [mm]	Terminal
	SY11	8539	red	5	10-12-14	
Phenolic Resin						
					SZ05F	
<p style="text-align: center;">yellow ↔ 500 mm</p>						

Basic	Type	Stock-No.	Colour	R [kΩ]	Ø [mm]	Terminal
	XY11	8584	red	5	10-12-14	
Phenolic Resin						
					XZ05F	
<p style="text-align: center;">yellow ↔ 500 mm</p>						

Basic	Type	Stock-No.	Colour	R [kΩ]	Ø [mm]	Terminal
	SD05FMC	8393	black	5	10-12	
Rubber sheathed						
					SD05FMC	
<p style="text-align: center;">red ↔ 500 mm</p>						

Basic	Type	Stock-No.	Colour	R [kΩ]	Ø [mm]	Terminal
	RC-X140	5937	black	5	10-12	
<p>Phenolic Resin</p>  <p style="text-align: center;">black 350 mm</p> <p style="text-align: right;">LD05EAK</p>						

Basic	Type	Stock-No.	Colour	R [kΩ]	Ø [mm]	Terminal
	J-1	8739	black	/		
						

PS/HP ↔ kW

PS/HP	kW	kW	PS/HP
1	0,736	1	1,360
30	22,065	20	27,192
35	25,742	25	33,991
40	29,420	30	40,789
45	33,097	35	47,587
50	36,775	40	54,385
55	40,452	45	61,183
60	44,130	50	67,981
65	47,807	55	74,779
70	51,485	60	81,577
75	55,162	65	88,375
80	58,840	70	95,173
85	62,517	75	101,972
90	66,195	80	108,770
95	69,872	85	115,568
100	73,550	90	122,366
105	77,227	95	129,162
110	80,905	100	135,962
115	84,582	105	142,760
120	88,260	110	149,558
125	91,937	115	156,356
130	95,615	120	163,154
135	99,292	125	169,953
140	102,970	130	176,751
145	106,647	135	183,549
150	110,325	140	190,347
155	114,002	145	197,145
160	117,680	150	203,943
165	121,357	155	210,741
170	125,035	160	217,539
175	128,712	165	224,337
180	132,390	170	231,135
185	136,067	175	237,934
190	139,745	180	244,732
195	143,422	185	251,530
200	147,100	190	258,328
205	150,777	195	265,126
210	154,455	200	271,924
215	158,132	205	278,722
220	161,810	210	285,520
225	165,487	215	292,318
230	169,165	220	299,116
235	172,842	225	305,915
240	176,520	230	312,713
245	180,197	235	319,511
250	183,875	240	326,309
255	187,552	245	333,107
260	191,230	250	339,905
265	194,907	255	346,703
270	198,585	260	353,501
275	202,263	265	360,299

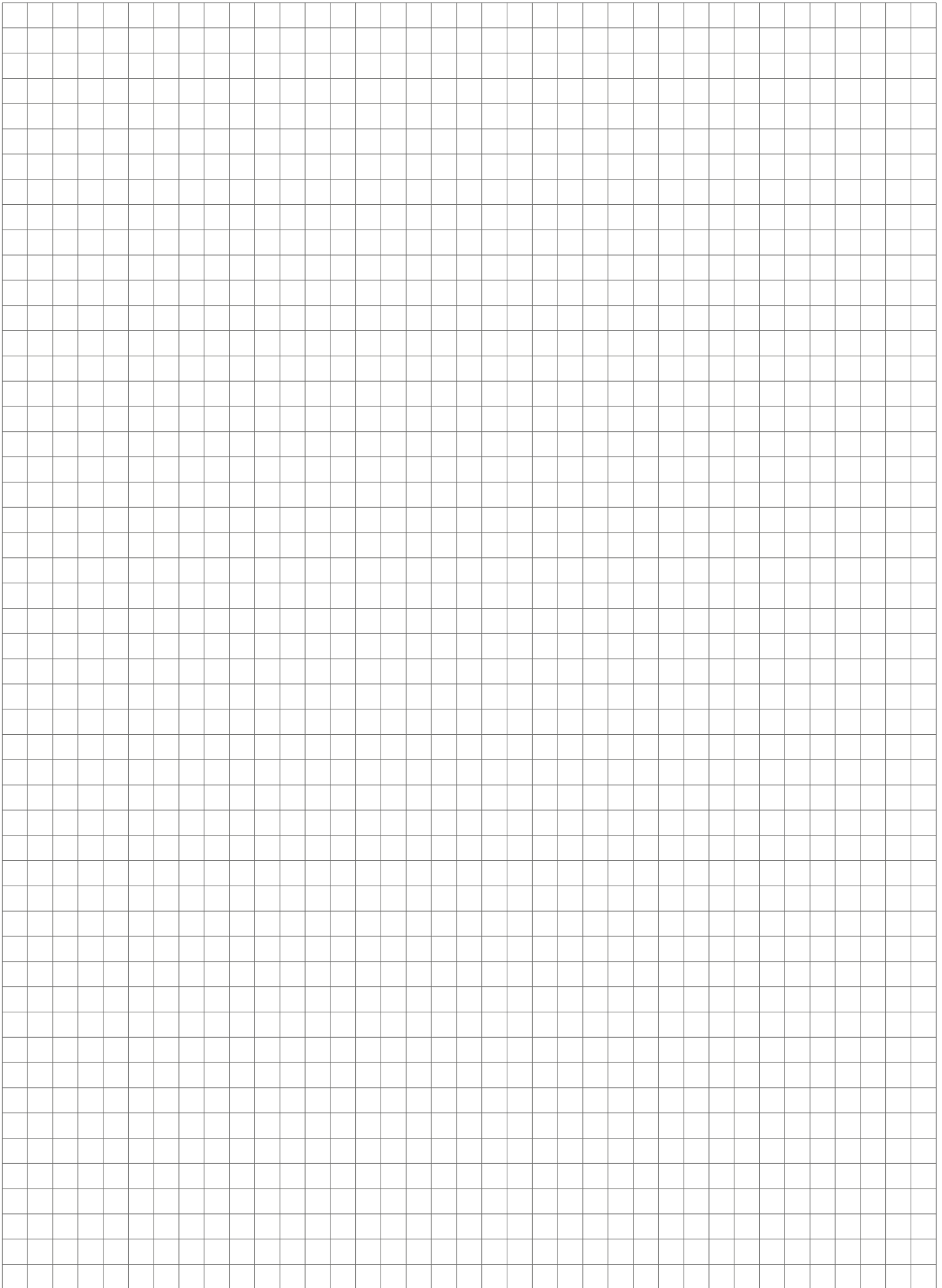

Spark plugs | Glow plugs | **NGK** | Lambda sensors | Ignition cables

Spark plug temperature (avg. avg)

1000 °C
850 °C
450 °C

0% Engine load 100%

Overheating region
Safety margin
Optimal temperature region
Fouling region

hot optimal cold

Engine load

The meaning of the heat rating

The generation of heat varies greatly from engine to engine. For example, a lawn mower will generate less heat than a racing car or a turbocharged engine can run significantly hotter than a naturally aspirated engine.

Therefore a spark plug must be selected that can conduct a precisely defined amount of heat energy to the cylinder head and ensure that the optimal operating temperature range is maintained.

The heat rating of a spark plug provides information about its thermal performance. The following applies for NGK spark plugs: The higher the heat rating number, the higher the thermal performance.

The heat rating number is to be found within the technical part number designation which is marked on the body of NGK's spark plugs (e.g. BKR6ES).

Spark plugs/Requirements/The meaning of the heat rating

Spark plugs | Glow plugs | **NGK** | Lambda sensors | Ignition cables

Ignition sequence

In older systems a central ignition coil generates the high voltage necessary for the ignition of the air-fuel mixture.

A mechanical ignition distributor ensures that this voltage is sent to the correct cylinder's spark plug at the right time.

The ignition high voltage is fed through a distributor cap and the ignition HT lead which is connected to the spark plug terminal. From here it reaches the tip of the centre electrode and when sufficient voltage is available to overcome the resistance of the air gap between the centre and ground electrode electrical energy discharges to earth in the form of a spark.

In more modern systems an individual 'pencil coil' is often fitted directly to each spark plug. With these fully-electronic ignition systems neither mechanical ignition distributors or high-voltage ignition cables are required.

Speed: fast slow

Spark plugs/Principles/ignition sequence





NGK SPARK PLUG EUROPE GMBH

Harkortstraße 41 · 40880 Ratingen · Germany
Fon + 49 21 02-974-100 · Fax + 49 21 02-974-149
www.ngk-europe.com

